

## Errata

**Title & Document Type:** 8752A/B Network Analyzer Operating and Programming Manual

**Manual Part Number:** 08752-90054P1

**Revision Date:** August 1991

---

### HP References in this Manual

This manual may contain references to HP or Hewlett-Packard. Please note that Hewlett-Packard's former test and measurement, semiconductor products and chemical analysis businesses are now part of Agilent Technologies. We have made no changes to this manual copy. The HP XXXX referred to in this document is now the Agilent XXXX. For example, model number HP8648A is now model number Agilent 8648A.

### About this Manual

We've added this manual to the Agilent website in an effort to help you support your product. This manual provides the best information we could find. It may be incomplete or contain dated information, and the scan quality may not be ideal. If we find a better copy in the future, we will add it to the Agilent website.

### Support for Your Product

Agilent no longer sells or supports this product. You will find any other available product information on the Agilent Test & Measurement website:

[www.tm.agilent.com](http://www.tm.agilent.com)

Search for the model number of this product, and the resulting product page will guide you to any available information. Our service centers may be able to perform calibration if no repair parts are needed, but no other support from Agilent is available.

# **HP 8752A/B NETWORK ANALYZER OPERATING AND PROGRAMMING MANUAL**

## **SERIAL NUMBERS**

This manual applies directly to any instruments with the following serial prefix numbers:

HP 8752A – 2901A and above

HP 8752B – 3038A and above

If the serial number of your instrument is not listed on this page, refer to the "Instrument History" section of this manual.

©Copyright            HEWLETT-PACKARD COMPANY            1990  
1400 FOUNTAINGROVE PARKWAY, SANTA ROSA, CA 95403 U.S.A.

SERVICE MANUAL PART NO. 08752-90054  
P/O Operating and Service Manual Set Part No. 08752-90053

Printed: AUGUST 1991  
EDITION 2



## **CERTIFICATION**

*Hewlett-Packard Company certifies that this product met its published specifications at the time of shipment from the factory. Hewlett-Packard further certifies that its calibration measurements are traceable to the United States National Institute of Standards and Technology (NIST, formerly NBS), to the extent allowed by the Institute's calibration facility, and to the calibration facilities of other International Standards Organization members.*

## **WARRANTY**

This Hewlett-Packard system product is warranted against defects in materials and workmanship for a period corresponding to the individual warranty periods of its component products. Computer and computer peripherals are warranted for a period of 90 days. Instruments are warranted for a period of one year. During the warranty period, Hewlett-Packard Company will, at its option, either repair or replace products which prove to be defective.

Warranty service for products installed by HP and certain other products designated by HP will be performed at Buyer's facility at no charge within HP service travel areas. Outside HP service travel areas, warranty service will be performed at Buyer's facility only upon HP's prior agreement and Buyer shall pay HP's round trip travel expenses. In all other areas, products must be returned to a service facility designated by HP.

For products returned to HP for warranty service, Buyer shall prepay shipping charges to HP and HP shall pay shipping charges to return the product to Buyer. However, Buyer shall pay all shipping charges, duties, and taxes for products returned to HP from another country.

HP warrants that its software and firmware designated by HP for use with an instrument will execute its programming instructions when properly installed on that instrument. HP does not warrant that the operation of the instrument, or software, or firmware will be uninterrupted or error free.

## **LIMITATION OF WARRANTY**

The foregoing warranty shall not apply to defects resulting from improper or inadequate maintenance by Buyer, Buyer-supplied software or interfacing, unauthorized modification or misuse, operation outside of the environmental specifications for the product, or improper site preparation or maintenance.

**NO OTHER WARRANTY IS EXPRESSED OR IMPLIED. HP SPECIFICALLY DISCLAIMS THE IMPLIED WARRANTIES OR MERCHANTABILITY AND FITNESS FOR A PARTICULAR PURPOSE.**

## **EXCLUSIVE REMEDIES**

**THE REMEDIES PROVIDED HEREIN ARE BUYER'S SOLE AND EXCLUSIVE REMEDIES. HP SHALL NOT BE LIABLE FOR ANY DIRECT, INDIRECT, SPECIAL, INCIDENTAL, OR CONSEQUENTIAL DAMAGES, WHETHER BASED ON CONTRACT, TORT, OR ANY OTHER LEGAL THEORY.**

## **ASSISTANCE**

*Product maintenance agreements and other customer assistance agreements are available for Hewlett-Packard products.*

*For any assistance, contact your nearest Hewlett-Packard Sales and Service Office. Addresses are provided at the back of this manual.*

## HP 8752A Network Analyzer Documentation Map

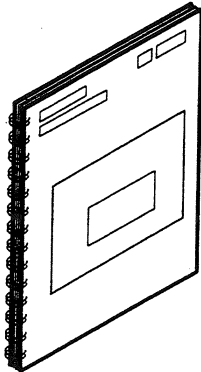

The **User's Guide** walks you through system setup and initial power-on, shows how to make basic measurements, explains commonly-used features, and tells you how to get the most performance from your analyzer.

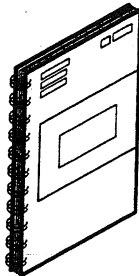

The **User's Quick Reference** provides a summary of all available user features. It is organized alphabetically by front panel key.

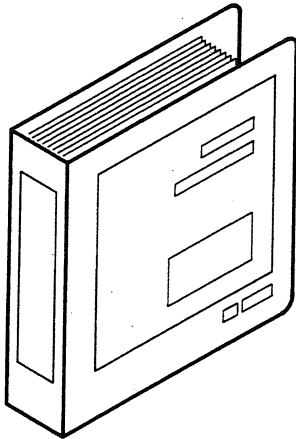

The **Operating Manual** provides general information, specifications, HP-IB Programming information, and in-depth reference information.

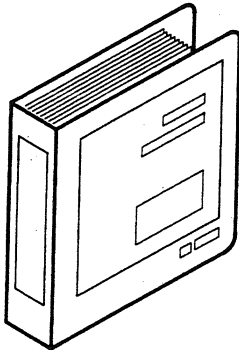

The **Service Manual** explains how to verify conformance to published specifications, adjust, troubleshoot, and repair the instrument.

# HP 8752A/B Operating Manual

## TABLE OF CONTENTS

<b>CHAPTER 1. GENERAL INFORMATION</b>			
Introduction	1-1	Dynamic Range	2-8
Operating Manual	1-1	Noise Floor	2-8
Service Manual	1-2	Crosstalk	2-8
HP 8752 Description	1-2	Typical Measurement Uncertainty for HP 8752A	2-9
General	1-2	Typical Measurement Uncertainty for HP 8752B	2-11
Plotter/printer buffer	1-2	Measurement Port Characteristics	2-13
Noise reduction and measurement calibration	1-2	Sources of Measurement Errors	2-14
The instrument and supplied cables		Systematic Error Sources	2-14
are a matched set	1-2	Random Error Sources	2-14
Automated operation without an		Drift Errors	2-14
external computer	1-3	Determining Expected System Performance	2-15
Automated operation with an external computer	1-3	Determining Crosstalk	2-13
Specific Computer Requirements	1-4	Appendix to System Performance	2-21
Equipment required	1-4	<b>CHAPTER 3. HP-IB REMOTE PROGRAMMING</b>	
Options	1-4	Introduction	3-1
Hardware options	1-4	How HP-IB Works	3-2
Warranty and support options	1-5	Talker	3-2
Measurement Accessories	1-5	Listener	3-2
Calibration Kits	1-5	Controller	3-2
Verification Kit	1-6	HP-IB Bus Structure	3-3
Test Port Return Cables	1-6	Data Bus	3-3
Adapter Kits	1-6	Handshake Lines	3-3
System Accessories	1-7	Control Lines	3-3
System Rack	1-7	HP-IB Requirements	3-5
Plotters and Printers	1-7	Analyzer HP-IB Capabilities	3-5
Disk Drives	1-7	Bus Mode	3-6
HP-IB Cables	1-7	Setting Addresses	3-7
Power and Environmental Requirements	1-8	Valid Characters	3-7
Servicing and Shipping the Instrument	1-9	Code Naming Convention	3-7
Servicing the Instrument	1-9	Units and Terminators	3-8
Instruments Documented by the Manual	1-9	HP-IB Debug Mode	3-8
		Display Graphics	3-8
<b>CHAPTER 2. SPECIFICATIONS</b>		<b>CHAPTER 4. SYSTEM OVERVIEW</b>	
Determining Dynamic Accuracy	2-3	System Overview	4-1
Example: Reflection Dynamic Accuracy	2-3	Overall Operation	4-1
Example: Transmission Dynamic Accuracy	2-3	The Built-in Synthesized Source	4-2
Supplemental Characteristics	2-4	The Receiver Block	4-2
Measurement Throughput Summary	2-4	Calibration Standards	4-2
Remote Programming	2-4	Data Processing	4-2
Interface	2-4	Overview	4-2
Transfer Formats	2-4	Channel 1 and Channel 2 have Independent	
Interface Function Codes	2-4	Data Processing Paths	4-3
Group Delay Characteristics	2-5	Important Concepts	4-3
Front Panel Connectors	2-6	Processing Details	4-4
Rear Panel Connectors	2-6	<b>CHAPTER 5. FRONT AND REAR PANEL</b>	
External Reference Frequency Input		Introduction	5-1
(EXT REF INPUT)	2-6	Active Function	5-1
External Auxiliary Input (AUX INPUT)	2-6	Front Panel Keys and Softkey Menus	5-1
External AM Input (EXT AM)	2-6	Why some Softkeys are Joined by Vertical Lines	5-2
External Trigger (EXT TRIGGER)	2-6	Softkeys that Toggle On or Off	5-2
Line Power	2-6	Softkeys that Show Status Indications	
Probe Power	2-6	in Brackets	5-2
Environmental Characteristics	2-7	Main Key Function Groups	5-2
Operating Conditions	2-7	HP-IB Control	5-3
Non-Operating Conditions	2-7	Front Panel Features	5-4
Weight	2-7	Display	5-6
Cabinet Dimensions	2-7	Status Notations	5-7
System Performance	2-8	Rear Panel Features and Connections	5-8
Introduction	2-8		

<b>CHAPTER 6. ACTIVE CHANNEL BLOCK</b>	
Active Channel Keys (CHAN1, CHAN2)	6-1
<b>CHAPTER 7. RESPONSE FUNCTION BLOCK</b>	
Introduction	7-1
[MEAS] Key	7-3
Measurement Type Menu	7-4
Conversion Menu	7-5
[FORMAT] Key	7-6
Format Menu	7-6
Format More Menu	7-11
Group delay principles	7-11
[SCALE REF] Key	7-14
Scale Reference Menu	7-14
[DISPLAY] Key	7-16
Display Menu	7-16
Display More Menu	7-19
Adjust Display Menu	7-20
Modify Colors Menu	7-21
Color Adjust Menu	7-22
Adjusting Color	7-22
Setting Default Colors	7-23
Saving Modified Colors	7-23
Recalling Modified Colors	7-23
Title Menu	7-24
Title More Menu	7-25
[AVG] Key	7-25
Average Menu	7-28
What is Measurement Calibration?	7-34
Built-In vs User-Performed Measurement Calibration	7-34
When a User-Performed Calibration is Necessary	7-35
Measurement Calibration Theory	7-34
Types of User-Performed Measurement	
Calibrations	7-35
Sources of Measurement Errors	7-36
Directivity	7-36
Source Match	7-37
Load Match	7-37
Isolation (Crosstalk)	7-38
Tracking	7-39
Reducing Measurement Errors	7-39
When Using a Male Test Port	7-40
When Measuring Response vs Frequency with a Polar or Smith Chart Display: Why Some Calibration Standards Exhibit a Curved Response	7-40
Menus and Softkeys	7-43
[CAL] Key	7-43
Correction Menu	7-45
Cal Kit Menu	7-46
Calibrate More Menu	7-47
Reference Plane Menu	7-49
Calibration Menu	7-50
Modifying Calibration Kits	7-52
Definitions	7-53
Procedure	7-53
Modify Cal Kit Menu	7-53
Define Standard Menus	7-55
Specify Offset Menu	7-58
Label Standard Menu	7-59
Specify Class Menus	7-60
Label Class Menus	7-62
Label Kit Menu	7-62
Verify Performance	7-62
Example Procedure for Specifying a User-Defined Calibration Kit	7-63

Appendix to Measurement Calibration	7-65
Using Markers	7-75
[MKR] Key	7-75
Marker Menu	7-77
Delta Marker Mode Menu	7-78
Fixed Marker Menu	7-79
Marker Mode Menu	7-81
Polar Marker Menu	7-82
Smith Marker Menu	7-83
[MKR FCTN] Key	7-84
Marker Function Menu	7-84
Marker Search Menu	7-86
Target Menu	7-88
Calibration Menu	7-50

## CHAPTER 8. STIMULUS FUNCTION BLOCK

Introduction	8-1
[START], [STOP], [CENTER], and [SPAN] Keys	8-2
[MENU] Key	8-2
Stimulus Menu	8-3
Power Menu	8-6
Trigger Menu	8-7
Sweep Type Menu	8-8
Creating a Frequency List	8-10
Editing a Segment	8-10
Printing the Frequency List	8-10
Single/All Segment Menu	8-11
Edit List Menu	8-12
Edit Segment Menu	8-13

## CHAPTER 9. ENTRY BLOCK

Entry Block Keys	9-1
------------------	-----

## CHAPTER 10. INSTRUMENT STATE BLOCK

Introduction	10-1
Instrument State Block Functions and Where They Are Described	10-2
[SYSTEM] Key	10-2
[LOCAL] Key	10-4
Local Lockout	10-4
HP-IB Menu	10-4
Talker/Listener Mode	10-5
System Controller Mode	10-5
Pass Control Mode	10-5
Address Menu	10-7
Limit Lines and Testing	10-11
What are Limit Lines and Limit Testing?	10-11
Limit Lines and Limit Testing are Independent Functions	10-11
How Limit Lines are Entered	10-12
Turning Limit Lines and Limit Testing On and Off	10-14
Limit Lines Do Not Need to be Entered in Order	10-14
Saving the Limit Line Table	10-14
Offsetting the Stimulus or Amplitude Values of the Limit Lines	10-14
Supported Display Formats	10-14
Use a Sufficient [NUMBER of POINTS] or Errors May occur	10-14
Displaying, Printing, or Plotting Limit Test Data	10-15
Results of Plotting or Printing the Display with Limit Lines On	10-15
Example of Use	10-15
Limits Menu	10-16
Creating New Limit Line Definitions	10-16
Turning Limit Lines On and Off	10-16

Turning Beep Fail Off .....	10-16	In Reflection Measurements .....	10-64
Offsetting the Stimulus or Amplitude Settings .....	10-17	Gating .....	10-65
Menu Control .....	10-17	Transforming CW Time Measurements into the	
Edit Limits Menu .....	10-17	Frequency Domain .....	10-67
Adding a New Segment .....	10-17	Forward Transform Measurements .....	10-67
Segment Editing Softkeys .....	10-18	Demodulating the Results of the	
Edit Segment Menu .....	10-18	Forward Transmission .....	10-68
Setting Stimulus Value .....	10-19	Forward Transform Range .....	10-69
Setting Limit Values .....	10-19	Printing and Plotting .....	10-73
Making an Entry or Correction Final .....	10-19	Introduction .....	10-73
Limit Type Menu .....	10-20	About Printing and Plotting, Where Compatible	
Menu Control .....	10-21	Printers and Plotters are Mentioned .....	10-73
Offset Limits Menu .....	10-22	Where to Find Tutorial Information .....	10-73
Test Sequencing .....	10-25	Printing with or without a Computer Controller	
Introduction .....	10-25	on the Bus .....	10-73
What is Test Sequencing? .....	10-25	Print/Plot Buffer .....	10-74
System Key Menu .....	10-26	[ <b>COPY</b> ] Key .....	10-74
Existing Sequence Selection Menu .....	10-27	Copy Menu .....	10-74
Sequence Menu .....	10-28	Print/Plot Setups Menu .....	10-76
New/Modify Sequence Menu .....	10-29	Select Quadrant Menu .....	10-77
Description of the Menu Selections .....	10-30	Define Plot Menu .....	10-78
Store Sequence to Disk Menu .....	10-30	Configure Plot Menu .....	10-79
Load Sequence from Disk Menu .....	10-31	Screen Menu .....	10-81
Description of the Menu Selections .....	10-31	Save and Recall .....	10-85
Purge Sequence from Disk Menu .....	10-32	Introduction .....	10-85
Sequence More Menu .....	10-33	What this section explains .....	10-86
Sequencing Special Functions .....	10-34	When Saving to Internal Memory .....	10-86
Important Concepts .....	10-35	When Saving to Disk .....	10-86
Autostarting Sequences .....	10-35	About Test Sequences .....	10-86
Sequencing Special Function Menu .....	10-36	Saving to Internal Memory .....	10-86
Sequencing Decision Making Menu .....	10-37	What is Saved .....	10-86
Sequencing Special Function More Menu .....	10-38	Saving to Disk .....	10-87
HP-GL Considerations .....	10-40	What Information is Saved to Disk by Default .....	10-87
HP-GL Commands Can be Entered Locally, or		Optional Information You Can Save To disk .....	10-87
Included in a Sequence .....	10-40	Which External Computers Can Read the Analyzer's Disks	
Special Commands Required for HP-GL .....	10-40	.....	10-87
Entering Sequences Using HP-IB .....	10-41	Which Network Analyzers Can Read the HP 8752's Data	
Reading Sequences Using HP-IB .....	10-41	Files .....	10-87
Decision-Making Sequence Examples .....	10-41	Volatile and Non-Volatile memory .....	10-87
Limit Test Example Sequences .....	10-41	Instrument states .....	10-88
Loop Counter Example Sequency .....	10-42	[ <b>SAVE</b> ] and [ <b>RECALL</b> ] keys .....	10-88
Time and Frequency Domain Transforms .....	10-47	Save and recall to internal memory .....	10-88
Introduction .....	10-47	Save and recall to external disk .....	10-88
General Theory .....	10-48	[ <b>SAVE</b> ] key menus .....	10-89
Time Domain Bandpass .....	10-49	Save Menu .....	10-89
Reflection Measurements Using Bandpass Mode .....	10-49	Clear Register Menu .....	10-90
Adjusting the Relative Velocity Factor .....	10-51	Title Register Menu .....	10-91
Transmission Measurements Using		Title Menu .....	10-92
Bandpass Mode .....	10-51	Store File Menu .....	10-93
Time Domain Low Pass .....	10-52	Define Store Menu .....	10-94
Setting Frequency Range for Time Domain		If you intend touse data files with an external computer or	
Low Pass .....	10-52	Hewlett-Packard's Microwave Design System .....	10-95
Reflection Measurements in Time Domain		Purge File Menu .....	10-97
Low Pass .....	10-53	Disk Menu .....	10-98
Fault Location Measurements Using Low Pass .....	10-55	Where to Find In-Depth CITIFile information .....	10-98
Transmission Measurements in Time Domain		Initialize Menu .....	10-99
Low Pass .....	10-56	Title File Menu .....	10-100
Time Domain Concepts .....	10-58	[ <b>RECALL</b> ] key menus .....	10-101
Masking .....	10-58	Recall Menu .....	10-101
Windowing .....	10-59	Load File Menu .....	10-102
Range .....	10-61	Appendix to save and recall – CITIFile ASCII file format	
Resolution .....	10-62	.....	10-105
Calculating Response Resolution .....	10-63		
In Transmission Measurements .....	10-63		
Example 1 .....	10-63		

**CHAPTER 11. CONNECTOR CARE**

**CHAPTER 12. ERROR MESSAGES**

Error Messages in Alphabetical Order ..... 12-1  
Error Messages in Numerical Order ..... 12-9

**CHAPTER 13. INSTRUMENT HISTORY**



## SAFETY CONSIDERATIONS

### GENERAL

This product and related documentation must be reviewed for familiarization with safety markings and instructions before operation. This product has been designed and tested in accordance with international standards.

### SAFETY SYMBOLS



Instruction manual symbol: the product will be marked with this symbol when it is necessary for the user to refer to the instruction manual (refer to Table of Contents).



Indicates hazardous voltages.



Indicates earth (ground) terminal.

#### WARNING

The WARNING sign denotes a hazard. It calls attention to a procedure, practice, or the like, which, if not correctly performed or adhered to, could result in personal injury. Do not proceed beyond a WARNING sign until the indicated conditions are fully understood and met.

#### CAUTION

The CAUTION sign denotes a hazard. It calls attention to an operating procedure, practice, or the like, which, if not correctly performed or adhered to, could result in damage to or destruction of part or all of the product. Do not proceed beyond a CAUTION sign until the indicated conditions are fully understood and met.

### SAFETY EARTH GROUND

This is a Safety Class I product (provided with a protective earthing terminal). An uninterruptible safety earth ground must be provided from the main power source to the product input wiring terminals, power, cord, or supplied power cord set. Whenever it is likely that the protection has been impaired, the product must be made inoperative and secured against any unintended operation.

### BEFORE APPLYING POWER

Verify that the product is configured to match the available main power source per the input power configuration instructions provided in this manual.

If this product is to be energized via an auto-transformer make sure the common terminal is connected to the neutral (grounded side of the mains supply).

### SERVICING

#### WARNING

*Any servicing, adjustment, maintenance, or repair of this product must be performed only by qualified personnel.*

*Adjustments described in this manual may be performed with power supplied to the product while protective covers are removed. Energy available at many points may, if contacted, result in personal injury.*

*Capacitors inside this product may still be charged even when disconnected from their power source.*

*To avoid a fire hazard, only fuses with the required current rating and of the specified type (normal blow, time delay, etc.) are to be used for replacement.*



**HP 8752 RF Network Analyzer**

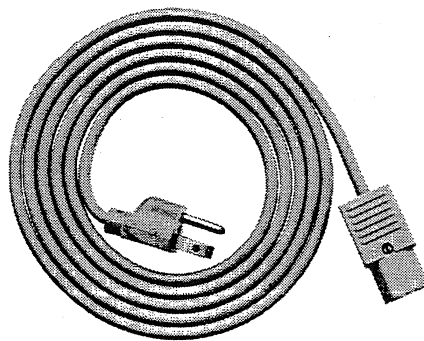

**Power Cable\***

\* Power cable/plug supplied depends on country of destination

*Figure 1-1. HP 8752 Network Analyzer with Power Cable Supplied*

# Chapter 1. General Information

---

## CONTENTS

- 1-1 Introduction
- 1-2 HP 8752 description
- 1-2 General
- 1-2 Noise reduction and measurement calibration
- 1-2 Plotter/printer buffer
- 1-2 The instrument and supplied cables are a matched set
- 1-3 Automated operation without an external computer
- 1-3 Automated operation with an external computer
- 1-4 Equipment required
- 1-4 Options
- 1-4 Hardware options
- 1-5 Warranty and support options
- 1-5 Measurement accessories
- 1-7 System accessories
- 1-8 Power and environmental requirements
- 1-9 Instruments documented by the manual

## INTRODUCTION

The manual set contains an *Operating Manual* and a *Service Manual*.

### Operating Manual

- **User's Guide**
- **Quick Reference**
- **HP-IB Programming**
- **Reference**

The **User's Guide** walks you through system setup and initial power-on, shows how to make basic measurements, and explains commonly-used features. The tutorials inside the *User's Guide* are for inexperienced users.

The **Quick Reference** briefly describes all instrument softkey menus and functions.

The **HP-IB Programming** section explains how to control the analyzer from an external computer.

The **Reference** provides in-depth information on each instrument key and softkey. This section also explains complex subjects such as measurement calibration, time domain, and more.

## Service Manual

The *Service Manual* provides the following information:

- How to verify instrument performance.
- How to perform a quick check of instrument functions.
- How to adjust the instrument.
- How to troubleshoot and repair the instrument.
- How to order replacement parts.

## HP 8752 DESCRIPTION

### CAUTION

A properly grounded AC outlet is mandatory when operating the HP 8752. Operating the instrument with an improperly grounded or floating ground prong may damage the instrument!

### CAUTION

Mating a 50 $\Omega$ (m) connector with a 75 $\Omega$ (f) connector will DESTROY the 75 $\Omega$  female.

## General

The HP 8752 is a high performance vector network analyzer for laboratory or production measurements of transmission and reflection parameters. It integrates a synthesized RF source and two separate measurement channels, a built-in transmission/reflection test set, and color display. No external equipment is required. An RF cable is supplied.

The HP 8752A provides 50 ohm transmission/reflection measurements and displays magnitude, phase, and group delay responses of active and passive RF networks. The HP 8752B provides the same features, but with a nominal system impedance of 75 ohms.

Two independent display channels and a large color screen display the measured results of one or both channels, in rectangular or polar/Smith chart formats.

Measurement functions are selected with front panel keys and softkey menus. Displayed measurement results can be printed or plotted directly to a compatible peripheral without the use of an external computer. Instrument states can be saved in internal memory for at least three days. In addition, the instrument can control a compatible disk drive for external storage capability.

## Plotter/Printer Buffer

The buffer allows a plot or print-out to be made while the instrument continues to make measurements.

## Noise Reduction and Measurement Calibration

Trace math, data averaging, trace smoothing, electrical delay, and measurement calibration improve the performance and flexibility of the instrument.

## The Instrument and Supplied Cable are a Matched Set

The network analyzer contains error correction factors for the supplied RF test cable. These factors are very specific, and apply to the cable actually shipped with the instrument. The error correction factors should be updated once per year, or whenever the cable is replaced. The procedure for doing this is supplied in the "Adjustments" chapter of the service manual. The internal correction feature is sensitive to the measurement setup, Figure 1-2 shows the optimum test setup.

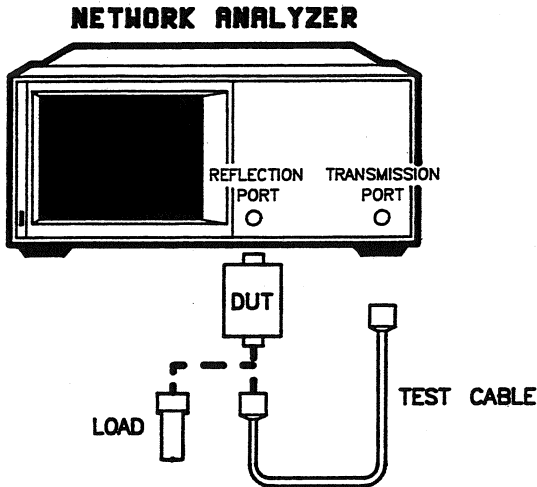

Figure 1-2. Optimum Test Setup for Use with Internal Error Correction

## AUTOMATED OPERATION WITHOUT AN EXTERNAL COMPUTER

The HP 8752 can control HP-IB compatible printers, plotters, and disk drives without the use of an external computer.

The test sequence function allows the operator to save all keystrokes in a particular measurement task, and have the HP 8752 perform them automatically at a later time. This feature combines simple operation with advanced features such as limit testing decisions, conditional branching, user-defined prompts, and others. Sequences may be stored to an optional external disk drive. Refer to the "User's Guide" or the "Reference," located in the *Operating Manual*.

## AUTOMATED OPERATION WITH AN EXTERNAL COMPUTER

This instrument can be remotely controlled by an external computer. The computer can control all instrument functions with the exception of some internal tests. The computer and instrument communicate over the Hewlett-Packard Interface Bus (HP-IB). Several output modes are available for outputting data. Through a subset of HP-GL (Hewlett-Packard Graphics Language), user graphics can be plotted on the instrument screen. A complete general description of HP-IB is available in *Condensed Description of the Hewlett-Packard Interface Bus* (HP part number 59401-90030), and in *Tutorial Description of the Hewlett-Packard Interface Bus* (HP literature number 5952-0156).

## Specific Computer Requirements

This network analyzer can be controlled by several types of computers:

- HP 9000 series 200 or 300 computer.
- HP Vectra Personal Computer using an HP 82300 HP BASIC Language Processor.
- MS-DOS® – compatible personal computer (PC), equipped with the HP 82990A “HP-IB Interface and Command Library.” Microsoft® QuickBASIC 4.0 is known to be fully compatible with the HP 82990A.

## EQUIPMENT REQUIRED

The HP 8752 is ready to use as shipped. No extra equipment is required.

## OPTIONS

### Hardware options

**Option 003, 3 GHz Operation.** This option extends the maximum frequency of the instrument to 3 GHz.

**Option 010, Time Domain.** Instruments equipped with option 010 can display the time domain response of a network by computing the inverse Fourier transform of the frequency domain response. The response of a test device can be viewed as a function of time or distance.

**Option 802, External Disk Drive.** This provides an HP 9122 dual 3.5 inch double-sided disk drive. A 1-meter (3.3 foot) HP-IB cable is supplied.

**Option 908, Rack Mount Kit for Instruments without Handles.** Option 908 is a rack mount kit containing a pair of flanges and the necessary hardware to mount the instrument, with handles detached, in an equipment rack with 482.6 mm (19 inches) horizontal spacing. This kit is separately available; order HP part number 5062-3978.

**Option 913, Rack Mount Kit for Instruments with Handles.** Option 913 is a rack mount kit containing a pair of flanges and the necessary hardware to mount the instrument with handles attached in an equipment rack with 482.6 mm (19 inches) spacing. This kit is separately available; order HP part number 5062-4072.

**Option 910, Extra Manual Set.** The standard instrument is supplied with an *Operating and Service Manual* set. Option 910 provides an additional manual set. After initial shipment, order extra manuals by part number. The numbers are listed on the title pages of the manuals and in the “Replaceable Parts” section of the *Service Manual*.

MS-DOS and Microsoft are U.S. registered trademarks of Microsoft, Incorporated.

## Warranty and Support Options

The HP 8752 includes a one-year on-site service warranty, where available. The “system” consists of an HP 8752 with a test port cable and a calibration kit (if purchased).

**Three Year Customer Return Repair Coverage (W30)** provides a total of three years of return-to-HP repair service from the time of product delivery.

**Three Year On-Site Repair Coverage (W31)** provides a total of three years of next day on-site coverage from the time of product delivery.

**Three Year Customer Return Calibration Coverage (W32)** provides scheduled calibrations in second and third years. Also provides full calibration after a repair performed by HP. Coverage begins at time of product delivery.

**Tool Kit.** A dedicated tool kit is available for HP 8752 troubleshooting, consisting of extender boards, extender cables, and adapters. The contents of the tool kit are listed in the *Service Manual*.

## MEASUREMENT ACCESSORIES

### Calibration Kits

Because of the built-in correction, calibration kits are optional. Measurement calibration requires the use of high-quality measurement standards. This makes it possible for the HP 8752 to calculate and compensate for measurement inaccuracies caused by the test setup. The following calibration kits contain precision standard devices with different connector types.

**HP 85032B Option 001 50 Ohm Type-N Calibration Kit.** The precision standards in this kit are used to calibrate the HP 8752A for measuring devices with type-N connectors. The kit consists of the following standards:

**NOTE:** The standard HP 85032B can be used instead of the option 001 version if desired (option 001 deletes 7 mm to type-N adapters).

- (1) type-N (m) 50 ohm termination
- (1) type-N (f) 50 ohm termination
- (1) type-N (m) short circuit
- (1) type-N (f) short circuit
- (1) type-N (m) open circuit with center conductor extender
- (1) type-N (f) open circuit

**HP 85033C Option 001 3.5 mm Calibration Kit.** This kit contains precision standards used to calibrate the HP 8752A for measuring devices with precision 3.5 mm connectors. The kit consists of the following standards:

- (1) 3.5 mm (m) 50 ohm termination
- (1) 3.5 mm (f) 50 ohm termination
- (1) 3.5 mm (f) short circuit
- (1) 3.5 mm (m) short circuit
- (1) 3.5 mm (f) open circuit with center conductor extender
- (1) 3.5 mm (m) open circuit with center conductor extender

In addition to the HP 85033C option 001, the HP 8752A requires:

- (2) Type N to 3.5 mm (m) adapters
- (2) Type N to 3.5 mm (f) adapters

(The HP 11878A adapter kit supplies these four adapters.)

**HP 85036B 75 Ohm Type-N Calibration Kit.** The standards in this kit are used to calibrate the HP 8752B. The kit consists of the following standards:

- (1) type-N (m) 75 ohm termination
- (1) type-N (f) 75 ohm termination
- (1) type-N (m) 75 ohm short circuit
- (1) type-N (f) 75 ohm short circuit
- (1) type-N (m) 75 ohm open circuit
- (1) type-N (f) 75 ohm open circuit with center conductor extender

Included in the HP 85036B cal kit are the following adapters:

- (1) Type-N (m) to Type-N (m) 75 ohm adapter
- (1) Type-N (f) to Type-N (f) 75 ohm adapter
- (1) Type-N (m) to Type-N (f) 75 ohm adapter

## **Verification Kit**

Accurate operation of the HP 8752 system can be verified by measuring known devices and comparing the results with recorded data. The HP 85032B (standard or option 001) is required for the HP 8752A. The HP 85036B is required for the HP 8752B. A system verification procedure is provided in the *Service Manual*.

## **Test Port Return Cable**

**Type-N RF Cable.** This is a replacement type-N cable (the cable supplied with the HP 8752). Order the cable if the connectors on your original cable have been damaged or show wear. HP part numbers: 8120-4781 (50 ohm for HP 8752A), or 8120-2408 (75 ohm for HP 8752B).

## **Adapter Kits**

**HP 11852B 50 to 75 Ohm Minimum Loss Pad.** This device converts impedance from 50 ohms to 75 ohms or from 75 ohms to 50 ohms. It is used to provide a low SWR impedance match between a 75 ohm device under test and the HP 8752A network analyzer or a 50 ohm measurement accessory. The HP 11852B may also be used to provide a good SWR impedance match between the HP 8752B and a 50 ohm measurement accessory.

The HP 8752A, a 50 ohm system, can measure 75 ohm devices if used with two HP 11852B minimum loss pads and a 75 ohm calibration kit (HP 85036B). The HP 8752B, a 75 ohm system, measures 75 ohm devices directly and uses a 75 ohm calibration kit (HP 85036B).

**HP 11853A 50 Ohm Type-N Adapter Kit.** This kit contains the connecting hardware required for making measurements on devices with 50 ohm type-N connectors.

**HP 11854A 50 Ohm BNC Adapter Kit.** This kit contains the connecting hardware required for making measurements on devices with 50 ohm BNC connectors.

**HP 11855A 75 Ohm Type-N Adapter Kit.** This kit contains the connecting hardware required for making measurements on devices with 75 ohm type-N connectors.

**HP 11856A 75 Ohm BNC Adapter Kit.** This kit contains the connecting hardware required for making measurements on devices with 75 ohm BNC connectors.

**HP 11878A 50 Ohm 3.5 mm Adapter Kit.** This kit contains the connecting hardware required for making measurements on devices with 50 ohm 3.5 mm connectors.



## **SYSTEM ACCESSORIES**

### **System Rack**

The HP 85043B system rack is a 124 cm (49 inch) high metal cabinet designed to rack mount the HP 8752 in a system configuration. The rack is equipped with a large built-in work surface, a drawer for calibration kits and other hardware, a bookshelf for system manuals, and a locking rear door for secured access. Lightweight steel instrument support rails support the instruments along their entire depth. Heavy-duty casters make the cabinet easily movable even with the instruments in place. Screw-down lock feet permit leveling and semi-permanent installation: the cabinet is extremely stable when the lock feet are down. Power is supplied to the cabinet through a heavy-duty grounded primary power cable, and to the individual instruments through special power cables included with the cabinet.

### **Plotters and Printers**

The HP 8752 is capable of plotting or printing displayed measurement results directly to a compatible peripheral without the use of an external computer.

The compatible plotters are:

- HP 7440A Option 002 ColorPro Eight-Pen Color Graphics Plotter, plots on ISO A4 or 8 1/2 x 11 inch charts.
- HP 7475A Option 002 Six-Pen Graphics Plotter, plots on ISO A4/A3 or 8 1/2 x 11 inch or 11 x 17 inch charts.
- HP 7550A High-Speed Eight-Pen Graphics Plotter, plots on ISO A4/A3 or 8 1/2 x 11 inch or 11 x 17 inch charts.
- HP 7090 Measurement Plotting System, is a high-performance six-pen programmable digital plotter. It plots on ISO A4/A3 or 8.5 x 11 inch or 11 x 17 inch paper or overhead transparency film.

The compatible printers for both printing and plotting are:

- HP 3630A PaintJet option 002 color printer
- HP 2225A (HP-IB compatible) ThinkJet printer
- HP 2227B QuietJet option 002 printer

### **Disk Drives**

The HP 8752 has the capability of storing instrument states directly to an external disk drive without the use of a computer. Any disk drive that uses CS80 protocol and HP 200/300 series (LIF) format is compatible. Disks may be formatted directly by the HP 8752. An HP 9122 Dual 3.5 inch floppy disk drive is supplied when the HP 8752 option 802 is ordered. Another recommended disk drive is the HP 9153C 20 Megabyte Winchester disk drive.

### **HP-IB Cables**

An HP-IB cable is required for interfacing the HP 8752 with a plotter, printer, external disk drive, or computer. The cables available are HP 10833A (1 m), HP 10833B (2 m), HP 10833C (4 m), and HP 10833D (0.5 m).

## POWER AND ENVIRONMENTAL REQUIREMENTS

**Rack Power Requirements.** If the system has been ordered with an HP 85043B rack, power will be supplied to the rack through its heavy-duty grounded primary power cable, and to the individual instruments in the rack through special power cables included with the rack. The rack should be connected to a circuit capable of supplying 2000 VA without interruption, and without interference from other equipment such as air conditioners or large motors.

**Replacing the Line Fuse.** To remove the fuse housing, remove the power cord and insert a small screwdriver into the slot at the base of the fuse housing. Pull forward and out. A spare fuse is also supplied in the fuse housing.

**Canadian Fuse Requirements.** A 3.0 amp fuse is required for use in Canada, regardless of the line voltage.

**Environmental Requirements.** Some instrument specifications are only warranted if the instrument is operated at  $25^{\circ}\text{C} \pm 5^{\circ}\text{C}$ . If a potential degradation in performance is acceptable, the instrument may be operated at the temperature range shown below:

- Temperature: Operating =  $0^{\circ}\text{C}$  to  $+55^{\circ}\text{C}$   
Storage =  $-40^{\circ}\text{C}$  to  $+75^{\circ}\text{C}$
- Humidity: This product must not be placed in an environment which causes moisture condensation.  
  
The instrument should be protected from temperature and humidity conditions that might cause internal condensation.
- Altitude: Operating = up to 4500 metres (approximately 15,000 feet)  
Storage = up to 15240 metres (50,000 feet)
- Conducted and radiated interference are in compliance with FTZ 526/527/1979.

The system can be operated in environments outside this range with a possibility of degradation in performance and a higher risk of failure. For temperature limitations on specified performance, refer to the table of specifications.

In addition to the above requirements, the following considerations should be observed:

- The environment should be as dust-free as possible, and any air filters in the instruments or system cabinet should be cleaned regularly.
- Electrostatic discharge (ESD) should be controlled by use of static-safe work procedures. For bench installation, an antistatic bench mat and wrist strap will decrease the possibility of damage from ESD. Part numbers for these items are provided in the replaceable parts section of the *Service Manual*, and in the *User's Guide*.

**Storing Rack-Mounted Systems.** If the system is rack-mounted, it must be stored with the rack standing upright. If the cabinet is stored in any other position with the instruments installed, the stress may cause mechanical and electrical damage to the instruments. The cabinet can be wheeled about its immediate installation area with the instruments installed, but care must be used since the instruments are sensitive and heavy. Turn the leveling foot on each bottom corner of the HP 85043B cabinet so that the feet do not interfere with movement. For safety's sake, have another person help guide and steady the cabinet.

## **SERVICING AND SHIPPING THE INSTRUMENT**

### **Servicing the Instrument**

This manual is intended for use by the operator of the HP 8752. Operating personnel must not remove the instrument covers. The instrument should be serviced only by qualified personnel who are aware of the hazards involved. Detailed safety precautions are described in the *Service Manual*.

**Packing for Shipment.** If the instrument or any of the system components is to be returned to Hewlett-Packard for service, attach a tag indicating the service required, return address, instrument model number, and full serial number, then pack as described below. The return address must be a mailing address, not a post office box. Use the blue service tags located at the end of the *Operating Manual*. In any correspondence, refer to the instrument by model number and full serial number.

A rack cabinet should never be shipped with the instruments installed. All instruments should be removed and individually packaged before shipment.

If any instrument is to be reshipped, it is best to use the original factory packaging materials. If these are not available, you can order similar containers and materials from the nearest Hewlett-Packard office. If other packaging materials are used, be sure to wrap the instrument (with service tag) in heavy paper or anti-static plastic, and place the wrapped instrument in a strong shipping container such as a double-wall carton made of 350-pound test material. Pack a three to four inch layer of shock absorbing material around the instrument. Seal the carton securely, and mark it FRAGILE.

### **INSTRUMENTS DOCUMENTED BY THE MANUAL**

The serial number on the back of the instrument is composed of two parts. The first four digits and letter comprise the *prefix*; the last five digits comprise the *suffix*.

The prefix is the same for all identical instruments; it changes only when a change is made to the instrument. The suffix, however, is assigned sequentially and is different for each instrument. This manual applies directly to instruments with the serial number prefix or prefixes listed on the title page.

History information on past instrument versions (if any) is provided in the "Instrument History" chapter.

Refer any questions to the nearest Hewlett-Packard Sales/Service Office. Always identify the instrument by model number, complete name, and complete serial number in all correspondence. A worldwide listing of HP Sales/Service Offices is provided at the back of this volume.

AC Power Cables Available

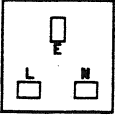
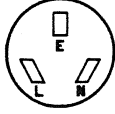
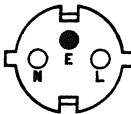
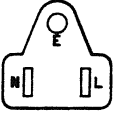
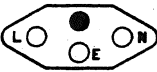
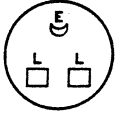
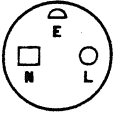
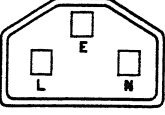
Plug Type <sup>1</sup>	Cable HP Part Number <sup>2</sup>	CD <sup>3</sup>	Plug Description <sup>2</sup>	Cable Length (inches)	Cable Color	For Use in Country
250V 	8120-1351 8120-1703	0 6	Straight BS1363A 90°	90 90	Mint Gray Mint Gray	United Kingdom, Cyprus, Nigeria, Zimbabwe, Singapore
250V 	8120-1369 8120-0696	0 4	Straight ZNSS198/ASC112 90°	79 87	Gray Gray	Australia, New Zealand
250V 	8120-1689 8120-1692	7 2	Straight CEE7-VII 90°	79 79	Mint Gray Mint Gray	East and West Europe, Saudi Arabia, Egypt, Republic of So. Africa, India (unpolarized in many nations)
125V 	8120-1348 8120-1398 8120-1754 8120-1378 8120-1521 8120-1676	5 5 7 1 6 2	Straight NEMA5-15P 90° Straight NEMA5-15P Straight NEMA5-15P 90° Straight NEMA5-15P	80 80 36 80 80 36	Black Black Black Jade Gray Jade Gray Jade Gray	United States, Canada, Japan (100V or 200V), Mexico, Philippines, Taiwan
250V 	8120-2104	3	Straight SEV1011.1959 24507, Type 12	79	Gray	Switzerland
250V 	8120-0698	6	Straight NEMA6-15P			United States, Canada
220V 	8120-1957 8120-2956	2 3	Straight DHCK 107 90°	79 79	Gray Gray	Denmark
250V 	8120-1860	6	Straight CEE22-VI (System Cabinet Use)			

1. E = Earth Ground; L = Line; N = Neutral  
2. Part number shown for plug is industry identifier for plug only. Number shown for cable is HP Part Number for complete cable including plug.  
3. The Check Digit (CD) is a coded digit that represents the specific combination of numbers used in the HP Part Number. It should be supplied with the HP Part Number when ordering any of the power assemblies listed above, to expedite speedy delivery.

## Chapter 2. Specifications

---

### INTRODUCTION

This chapter provides information on the stand-alone specifications and characteristics of the analyzer, and on the specified and typical performance of the analyzer system. The analyzer system consists of the analyzer plus the test cable supplied with (and matched to) the analyzer.

### ANALYZER SPECIFICATIONS AND CHARACTERISTICS

Table 2-1 lists specifications and typical characteristics of the stand-alone analyzer (without its matched cable). Specifications are the performance standards or limits against which the instrument can be tested. They are field verifiable using performance tests documented in the service manual.

Typical characteristics are not specifications but are non-warranted performance characteristics provided for use in applying the instrument. Typical characteristics are representative of most instruments, though not necessarily factory-tested in each unit. They are not field tested.

Table 2-2 lists supplemental characteristics of the instrument. These are general descriptive information provided for use in applying the instrument.

### SYSTEM SPECIFICATIONS AND SYSTEM PERFORMANCE

Table 2-3 lists measurement port specifications for the system (analyzer and matched cable). These specifications are the residual system uncertainties with and without error correction.

The last part of this chapter explains system performance and residual measurement errors. It provides a description of error sources, graphs of typical measurement uncertainty, and information on determining expected performance for a particular system.

Table 2-1. Instrument Specifications (1 of 2)

Specifications describe the instrument's warranted performance over the temperature range of 0° to 55°C (except where noted). Figures denoted as typical are not specifications but are non-warranted performance parameters provided for use in applying the instrument.

**SOURCE<sup>1</sup>**

**Frequency**

Range: standard 300 kHz to 1.3 GHz  
 option 003 300 kHz to 3 GHz  
 Resolution: 1 Hz  
 Stability: typically ±7.5 ppm 0 to 55°C  
 typically ±3 ppm/year  
 Accuracy: 10 ppm at 25°C ±5°C

**Output Power**

Test port power range: -20 to +5 dBm  
 Resolution: 0.1 dB  
 Flatness<sup>2</sup>: 2 dB Peak to Peak  
 Level accuracy<sup>2</sup>: ±0.5 dB at 50 MHz  
 Level linearity<sup>2</sup>: ±0.5 dB from -20 to -15 dBm  
 ±0.2 dB from -15 to 0 dBm  
 ±0.5 dB from 0 to +5 dBm

**RECEIVER<sup>1</sup>**

**Input**

Frequency range: Standard 300 kHz to 1.3 GHz  
 Option 003 300 kHz to 3 GHz  
 Dynamic range<sup>3</sup>: 100 dB

Maximum input level: 0 dBm at Transmission Port  
 10 dBm at Reflection Port  
 Damage Level: 20 dBm or >25 VDC at  
 Transmission Port  
 30 dBm or >25 VDC at Reflection Port  
 Crosstalk: (Reflection Port to Transmission Port)  
 300 kHz to 1.3 GHz: 100 dB  
 1.3 to 3 GHz: 90 dB

Noise level: 3 kHz BW Reflection -75 dBm (typical)  
 10 Hz BW Reflection -85 dBm (typical)  
 3 kHz BW Transmission -90 dBm  
 10 Hz BW Transmission -100 dBm  
 (typically -110 dBm)

**Magnitude**

**Phase**

Dynamic accuracy: Refer to Figure 2-1a.  
 Display resolution: 0.01 dB/div.  
 Marker resolution<sup>3</sup>: 0.001 dB  
 Trace noise: (0 dBm, 3 kHz BW; reflection):  
 <0.006 dB rms  
 (0 dBm, 3 kHz BW; transmission):  
 <0.006 dB rms  
 Reference level: range: ±500 dB  
 resolution: 0.001 dB  
 Stability: 0.02 dB/°C typically

Dynamic accuracy: Refer to Figure 2-1b.  
 Range: ±180 degrees  
 Frequency response (deviation from linear, -10 dBm,  
 25°±5°C): ±3°  
 Display resolution: 0.01°/div.  
 Marker resolution<sup>3</sup>: 0.01°  
 Trace noise: (0 dBm, 3 kHz BW; reflection):  
 <0.035° rms  
 (0 dBm, 3 kHz BW; transmission):  
 <0.035° rms  
 Reference level: range: ±500 degrees  
 resolution: 0.01 degrees  
 Stability: 0.1°/°C typically

1. HP 8752B option 003 specifications above 2 GHz are typical due to 75 ohm measurement standards having an upper frequency limit of 2 GHz  
 2. At 25°C±5°C relative to -5 dBm test port power.  
 3. This specification applies to transmission measurements in the 300 kHz to 1.3 GHz frequency range at 10 Hz IF bandwidth with response and isolation correction. Dynamic range is limited by maximum receiver input level and system noise floor.  
 4. Marker resolution is dependent upon the value measured; resolution is limited to five digits.

Table 2-1. Instrument Specifications (2 of 2)

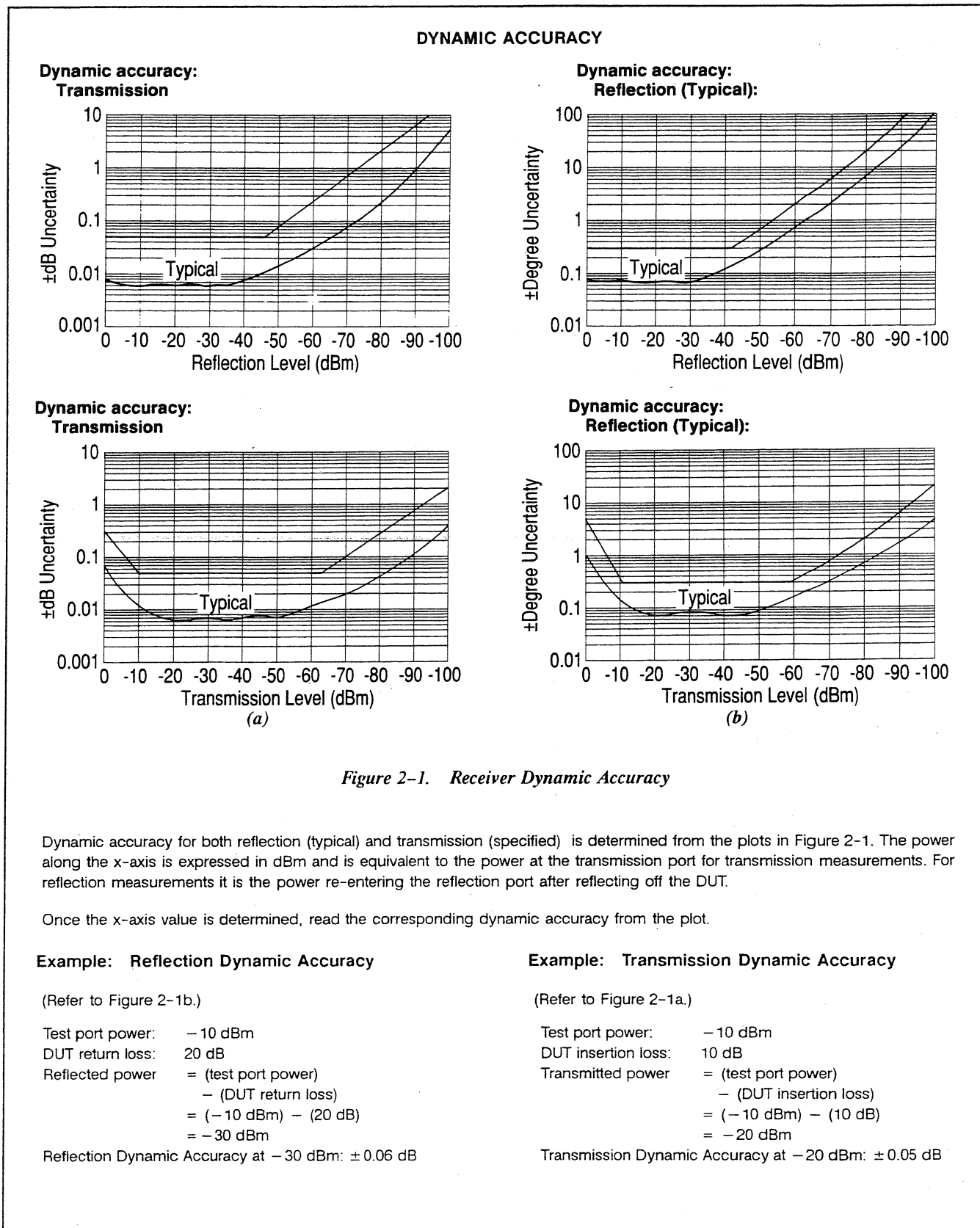

Table 2-2. Supplemental Characteristics (1 of 4)

These are not specifications, but general descriptive information provided for use in applying the instrument.

**MEASUREMENT THROUGHPUT SUMMARY**

The following shows typical measurement times in milliseconds.

*Typical time for completion (msec)*

	Number of Points			
	51	201	401	1601
<b>Measurement</b>				
Uncorrected or 1-port cal <sup>1</sup>	120	190	290	890
2-port cal	540	1030	1680	5610
<b>Time domain conversion<sup>2</sup></b>	125	540	1150	2840
<b>HP-IB data transfer<sup>3</sup></b>				
Internal	30	50	75	660
ASCII	500	1900	3800	15000
IEEE 754 floating point format:				
32 bit, 32 bit MS-DOS <sup>®</sup>	40	85	140	500
64 bit	60	125	210	700

**REMOTE PROGRAMMING**

**Interface**

HP-IB interface operates according to IEEE 488-1978 and IEC 625 standards and IEEE 728-1982 recommended practices.

**Transfer Formats**

Binary (internal 48-bit floating point complex format)

CITIFile ASCII

32/64 bit IEEE 754 Floating Point Format

**Interface Function Codes**

SH1, AH1, T6, TE0, L4, LE0, SR1, RL1, PP0, DC1, DT1, C1, C2, C3, C10, E2

1 Reflection 1-Port calibration with a 3 kHz IF BW. Includes system retrace time but does not include bandswitch time. Time domain gating is assumed off.

2. Option 010 only, gating off.

3 Measured with HP 9000 Series 300 computer

MS-DOS<sup>®</sup> is a U.S. registered trademark of Microsoft Corporation.



Table 2-2. Supplemental Characteristics (2 of 4)

**GROUP DELAY CHARACTERISTICS**

Group delay is computed by measuring the phase change within a specified frequency step (determined by the frequency span, and the number of points per sweep).

**Aperture:** Selectable

Maximum aperture: 20% of frequency span

Minimum aperture: (frequency span)/(number of points - 1)

**Range:**

The maximum delay is limited to measuring no more than 180° of phase change within the minimum aperture.

Range = 1/(2 x minimum aperture)

**Accuracy:**

The following graph shows group delay accuracy at 1.3 GHz with an uncorrected measurement. IF BW is 10 Hz. Insertion loss is assumed to be small and device electrical length is 10 meters.

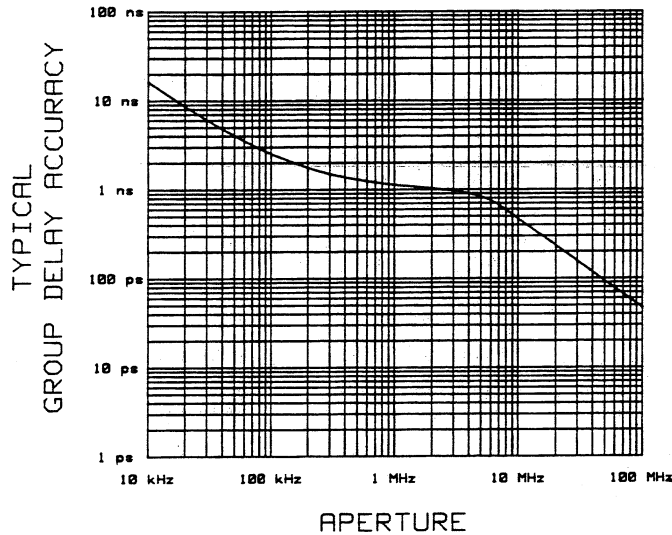

Figure 2-2. Group Delay Accuracy at 1.3 GHz

In general, the following formula can be used to determine the accuracy, in seconds, of a specific group delay measurement.

$$\pm (0.003 \times \text{Phase accuracy(deg)}) / \text{Aperture(Hz)}$$

Depending on the aperture and device length, the phase accuracy used is either incremental phase accuracy or worst case phase accuracy. The above graph shows this transition.

Table 2-2. Supplemental Characteristics (3 of 4)

**FRONT PANEL CONNECTORS**

	HP 8752A	HP 8752B
Connector Type	type-N (female)	type-N (female)
Impedance	50 ohms (nominal)	75 ohms (nominal)
Connector Pin Protrusion	0.204 to 0.207 in	0.204 to 0.207 in

**REAR PANEL CONNECTORS**

**External Reference Frequency Input (EXT REF INPUT)**

Frequency	1, 2, 5, and 10 MHz ( $\pm 200$ Hz @ 10 MHz)
Level	-10 dBm to +20 dBm, typical
Impedance	50 ohms

**External Auxiliary Input (AUX INPUT)**

Input Voltage Limits -10V to +10V

**External AM Input (EXT AM)**

$\pm 1$  volt into a 5k ohm resistor, 1 kHz maximum, resulting in 8 dB/volt amplitude modulation.

**External Trigger (EXT TRIGGER)**

Triggers on a negative TTL transition or contact closure to ground.

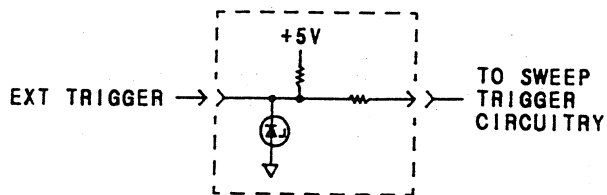

*External Trigger Circuit*

**LINE POWER**

47 to 66 Hz  
 115V nominal +10% -25% or 230V +10% -15%. 220 VA max.

**PROBE POWER**

+15V  $\pm 2\%$ , 400 mA  
 -12.6V  $\pm 5.5\%$ , 300 mA

**ENVIRONMENTAL REQUIREMENTS**

**Operating Conditions**

Temperature	0 to 55°C
Humidity	Operate in a non-condensing environment
Altitude	0 to 4500 meters (15,000 feet)

Table 2-2. Supplemental Characteristics (4 of 4)

**Non-Operating Storage Conditions**

Temperature     -40°C to +70°C  
Humidity        Store in a non-condensing environment  
Altitude        0 to 15,240 metres (50,000 feet)

**WEIGHT**

Net             25.4 kg (56 lb)  
Shipping       28.4 kg (63 lb)

**CABINET DIMENSIONS**

178 H x 425 W x 497.8 mm D  
(7.0 x 16.75 x 19.0 in)

(These dimensions exclude front and rear panel protrusions. Add 24 mm (1 in) to depth to include the front panel connectors.)

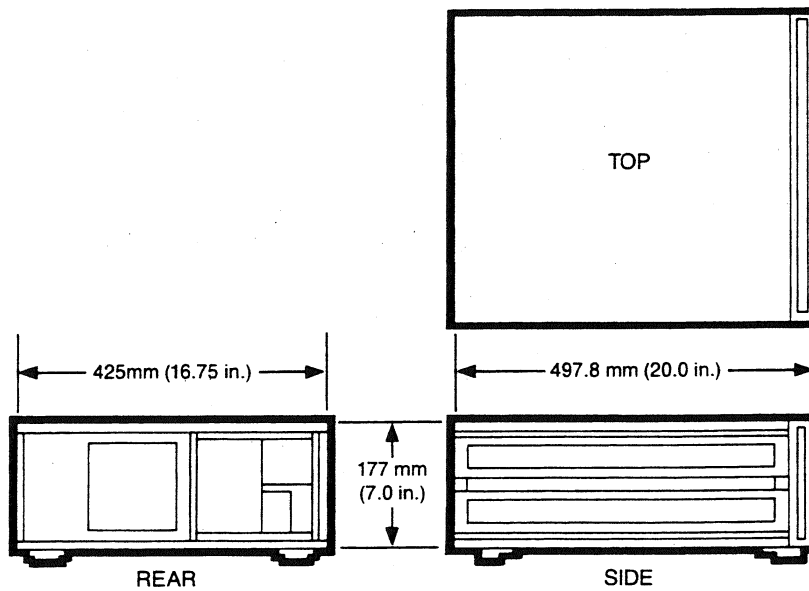

Table 2-3. System Specifications

**MEASUREMENT PORT UNCERTAINTIES**

The following specifications show the residual system uncertainties with and without error correction. The system is defined as the analyzer plus its matched cable. When two values are given for one specification (for example: 40/35), the number on the left applies up to 1.3 GHz, the number on the right applies from 1.3 to 3 GHz.

**NOTE:** All HP 8752B option 003 specifications above 2 GHz are typical due to 75 ohm measurement standards having an upper frequency limit of 2 GHz.

Error Term	Uncorrected <sup>1</sup>		3.5 mm <sup>2,3</sup>		Type-N <sup>3</sup>	
	dB	Linear	dB	Linear	dB	Linear
Directivity	-40/-35 <sup>4</sup>	0.01/0.0178	-40	0.01	-44	0.0063
Reflection Tracking	±0.2/±0.3	0.0233/ 0.0351	±0.06	0.0069	±0.06	0.0069
Transmission Tracking	±0.2/±0.3	0.0233/ 0.351	±0.05/ ±0.1	0.0058/ 0.0116	±0.05/ ±0.1	0.0058/ 0.0116
Source Match (reflection)	-30/-25	0.0316/ 0.0562	-36	0.0158	-35	0.0178
Source Match (transmission)	-23/-20	0.0708/0.1	-23/-20	0.0708/0.1	-23/-20	0.0708/0.1
Load Match	-23/-20	0.0708/0.1	-23/-20	0.0708/0.1	-23/-20	0.0708/0.1
Crosstalk	-100/-90	0.00001/ 0.00003	-100/-90	0.00001/ 0.00003	-100/-90	0.00001/ 0.00003
Connector Repeatability (typical)	-65	0.0006	-70	0.0003	-65	0.0006
<b>Error Term</b>			<b>dB</b>		<b>Linear</b>	
Noise Floor <sup>5</sup> . Transmission: (Included in dynamic accuracy)			-100 (10 Hz BW)		0.00001	
Trace Noise			0.006 dB rms		0.0007	
Cable Reflection Magnitude Stability (typical)			-60 dB		0.001	
<b>Error Term</b>			<b>Degrees</b>			
Cable Transmission Phase Stability (typical):			0.05 x Frequency (in GHz) degrees			

1. These uncertainties apply in an environmental temperature of 23° + 10/- 5°C with an IF bandwidth of 10 Hz  
 2. HP 8752A only.  
 3. These uncertainties apply in an environmental temperature of 23° ± 3°C, with less than 1° deviation from the temperature at measurement calibration. IF BW is 10 HZ.  
 4. -30 dB from 300 kHz to 10 MHz.  
 5. Noise floor is already included in dynamic accuracy performance data.

# SYSTEM PERFORMANCE

## INTRODUCTION

System performance depends not only on the performance of the analyzer and the cables, but also on operating conditions and on measurement errors inherent in network analysis.

The following pages provide a brief description of the sources of measurement errors, graphs of typical measurement uncertainty for the HP 8752A and 8752B, and information to use in determining the expected performance of a particular system.

Also provided are tips on increasing dynamic range by reducing associated measurement errors.

## INCREASING DYNAMIC RANGE

Dynamic range is limited by the maximum receiver input level (the high end of the range), and by either of these two factors on the minimum end of the range:

- System noise floor
- Crosstalk

### Noise Floor

System noise floor can be reduced using a narrow IF bandwidth or with averaging, or with a combination of both. These measures can reduce noise floor below the crosstalk error level, making crosstalk error the limiting factor in dynamic range. A response and isolation calibration can then reduce the crosstalk errors. *The noise floor must be less than the crosstalk error or a response and isolation calibration will not reduce crosstalk errors.* The "Calibration" chapter explains how to determine which is greater: noise floor or crosstalk

### Crosstalk

Crosstalk is a factor only in measurements requiring wide dynamic range. When crosstalk is greater than the noise floor, a response and isolation calibration can reduce its effects, thereby increasing dynamic range. However, if the noise floor is greater than crosstalk, the response and isolation cal will have no effect on dynamic range. The "Calibration" chapter explains this in detail.

## SOURCES OF MEASUREMENT ERRORS

Network analysis measurement errors can be separated into the following types of errors:

- Systematic errors.
- Random errors.
- Drift errors.

## Systematic Error Sources

The model for systematic errors is shown below. Refer to the end of the chapter for reflection uncertainty and transmission uncertainty equations derived from the system error model. Systematic errors result from imperfections in the calibration standards, connector standards, connector interface, interconnecting cables, and the instrumentation. All measurements are affected by dynamic accuracy.

**Errors in Reflection Measurements.** Directivity, source match, and reflection tracking are the errors that affect reflection measurements.

**Errors in Transmission Measurements.** Crosstalk, source match, load match, transmission tracking, and cable stability are the errors that affect transmission measurements.

Refer to the "Measurement Calibration" chapter for an explanation of each of these individual errors.

## Random Error Sources

Non-repeatable errors are trace noise, noise floor (included in dynamic accuracy), and connector repeatability. These errors affect both transmission and reflection measurements.

## Drift Errors

The effects of temperature drift are included in the system specifications data.

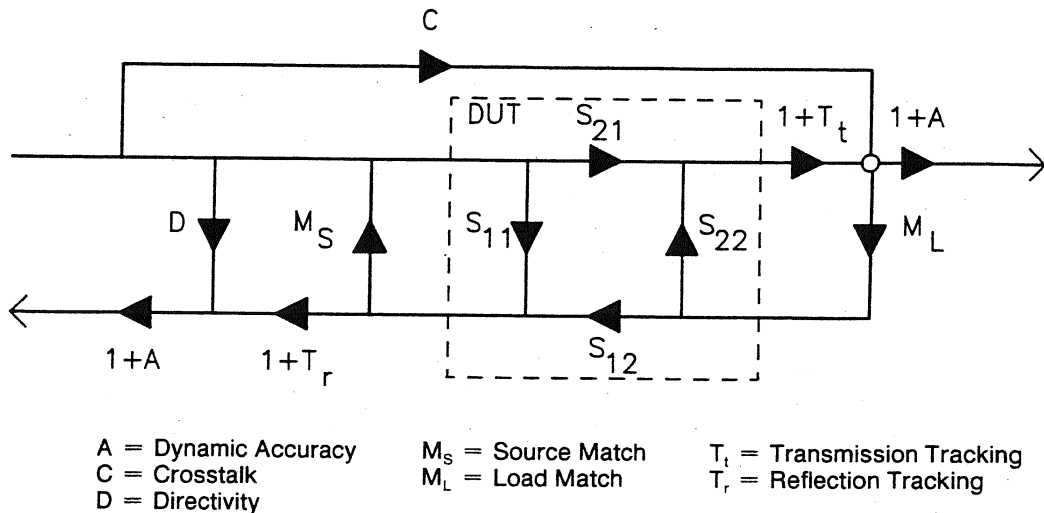

Figure 2-3. System Error Model

## TYPICAL MEASUREMENT UNCERTAINTY FOR HP 8752A

The graphs<sup>1</sup> below show the typical measurement uncertainty for the analyzer using type-N or 3.5 mm connectors, with and without error correction. Two graphs are provided for transmission measurements (a magnitude graph and a phase graph), and two for reflection measurements. The graphs on the next page apply to the HP 8752A option 003.

Corrected performance in the transmission measurement graphs shows the improvement obtained from a response and isolation calibration. Corrected performance in the reflection measurement graphs shows the improvement obtained from a reflection 1-port calibration.

### Transmission measurements<sup>2</sup>

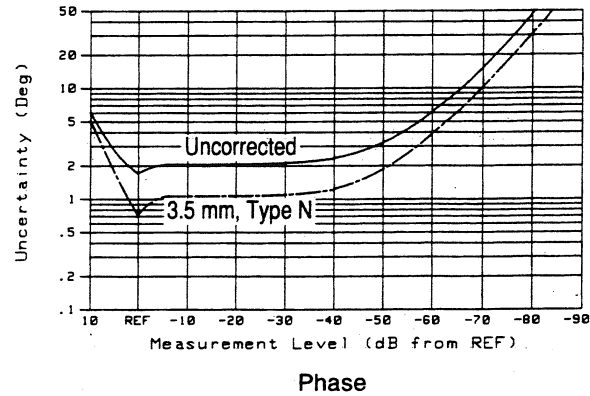
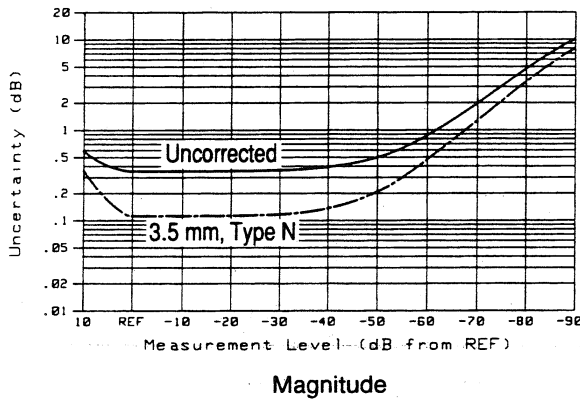

### Reflection measurements<sup>3</sup>

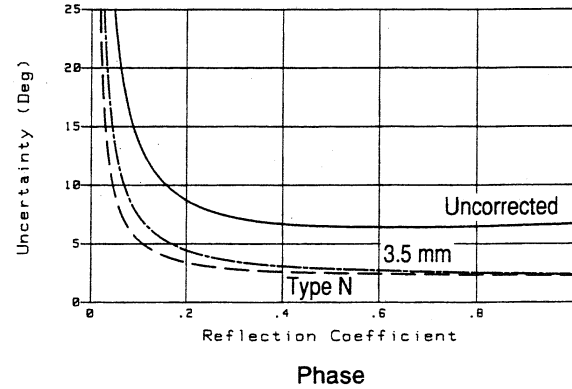
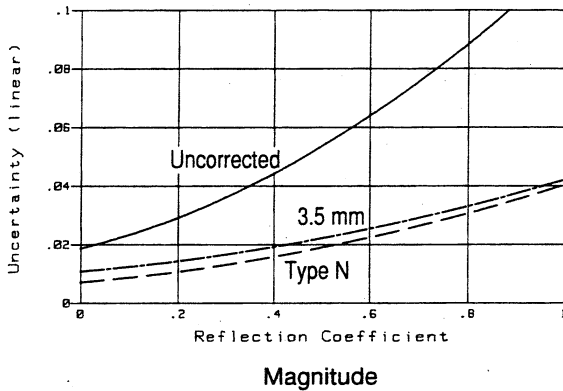
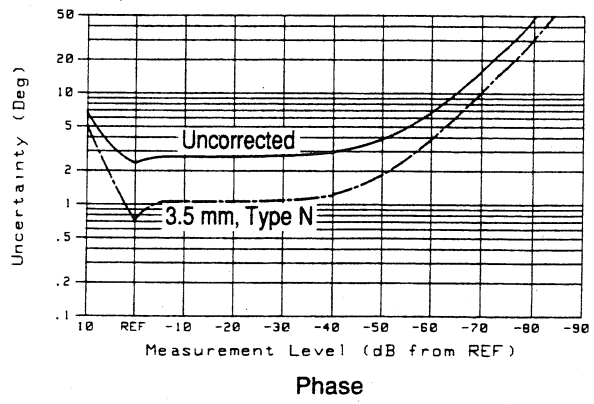
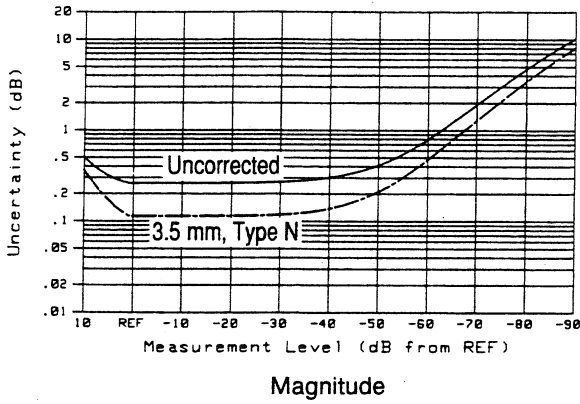

Figure 2-4. Typical Measurement Uncertainty for Standard HP 8752A (300 kHz to 1.3 GHz)

1. These measurement uncertainty curves utilize an RSS model for the contributions of random errors such as noise, and typical connector repeatabilities; and a worst-case model for the contributions of dynamic accuracy and residual systematic errors.
2. The graphs shown for transmission measurements assume a well-matched device ( $S_{11} = S_{22} = 0$ ).
3. The graphs for reflection measurement uncertainty apply to either a one-port device or a two-port device with more than 6 dB of insertion loss.

**Transmission measurements<sup>1</sup>**



**Reflection measurements<sup>2</sup>**

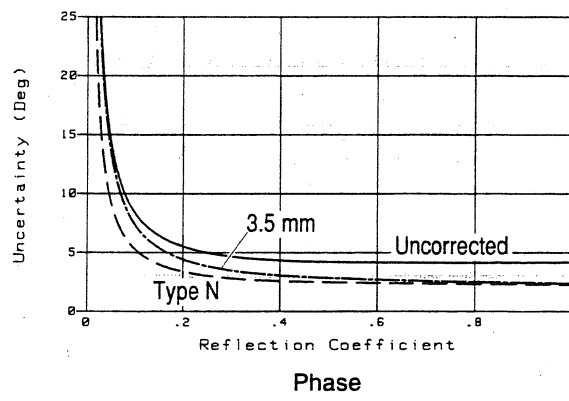
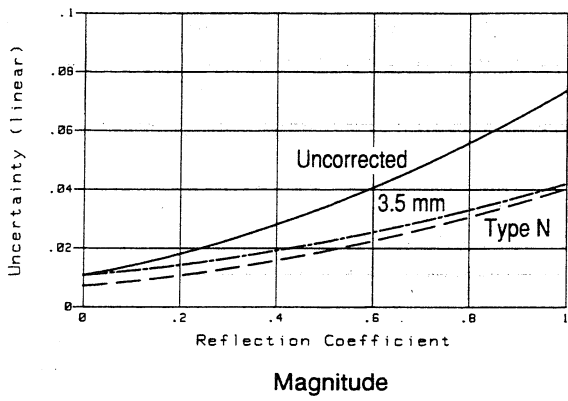

**Figure 2-5. Typical Measurement Uncertainty for HP 8752A Option 003 (300 kHz to 3 GHz)**

1. The graphs shown for transmission measurements assume a well-matched device ( $S_{11} = S_{22} = 0$ ).
2. The graphs for reflection measurement uncertainty apply to either a one-port device or a two-port device with more than 6 dB of insertion loss.



## TYPICAL MEASUREMENT UNCERTAINTY FOR HP 8752B

The graphs<sup>1</sup> below show the typical measurement uncertainty for the analyzer using type-N connectors, with and without error correction. Two graphs are provided for transmission measurements (a magnitude graph and a phase graph), and two for reflection measurements. The graphs on the next page apply to the HP 8752B option 003.

Corrected performance in the transmission measurement graphs shows the improvement obtained from a response and isolation calibration. Corrected performance in the reflection measurement graphs shows the improvement obtained from a reflection 1-port calibration.

### Transmission measurements<sup>2</sup>

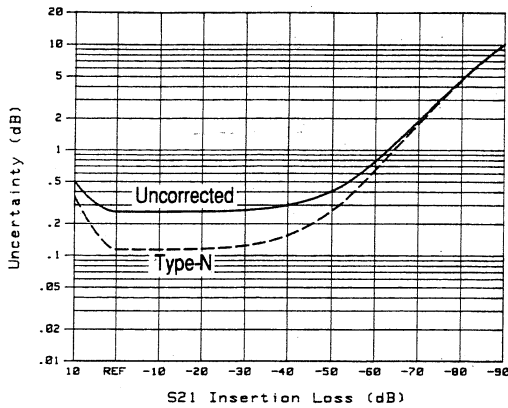

Magnitude

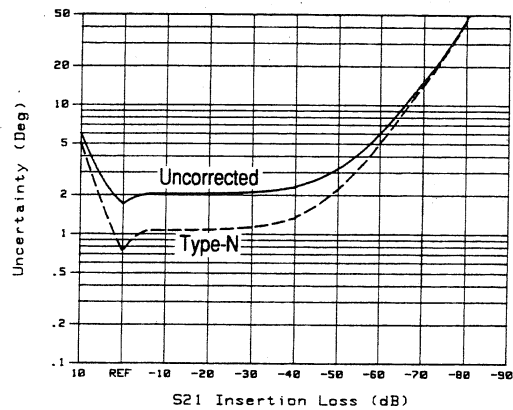

Phase

### Reflection measurements<sup>3</sup>

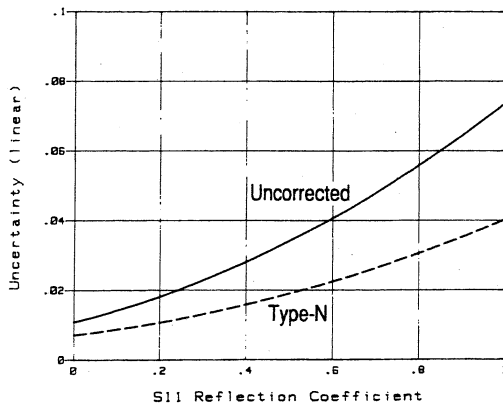

Magnitude

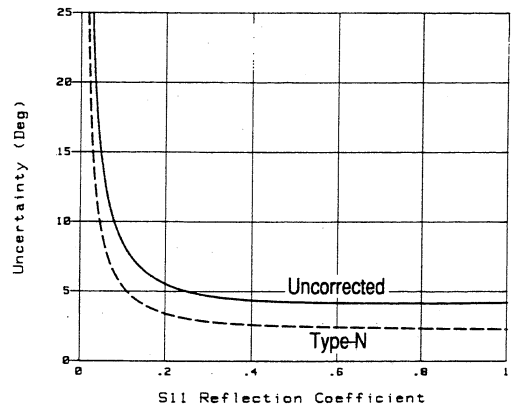

Phase

Figure 2-6. Typical Measurement Uncertainty for Standard HP 8752B (300 kHz to 1.3 GHz)

1. These measurement uncertainty curves utilize an RSS model for the contributions of random errors such as noise, and typical connector repeatabilities; and a worst-case model for the contributions of dynamic accuracy and residual systematic errors.
2. The graphs shown for transmission measurements assume a well-matched device ( $S_{11} = S_{22} = 0$ ).
3. The graphs for reflection measurement uncertainty apply to either a one-port device or a two-port device with more than 6 dB of insertion loss

### Transmission measurements<sup>1</sup>

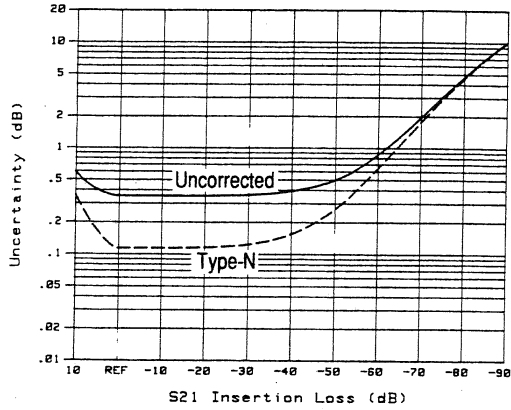

Magnitude

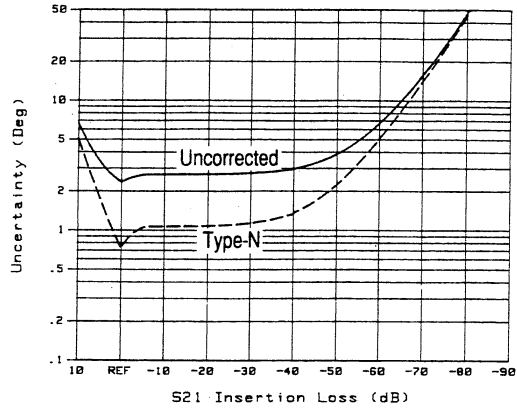

Phase

### Reflection measurements<sup>2</sup>

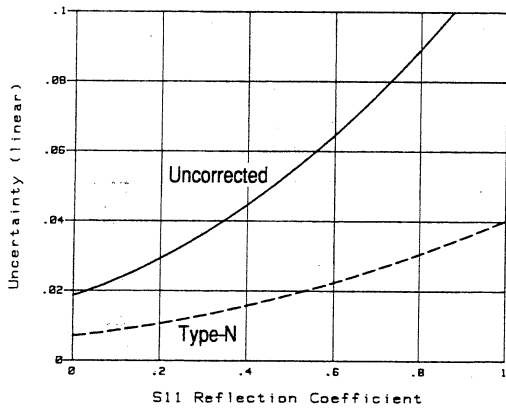

Magnitude

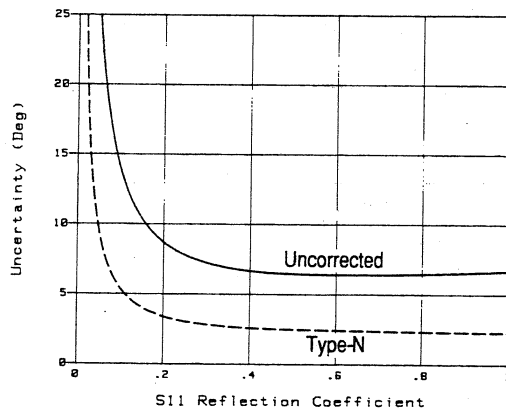

Phase

**Figure 2-14. Typical Measurement Uncertainty for HP 8752B Option 003 (300 kHz to 3 GHz)**

1. The graphs shown for transmission measurements assume a well-matched device ( $S_{11} = S_{22} = 0$ ).
2. The graphs for reflection measurement uncertainty apply to either a one-port device or a two-port device with more than 6 dB of Insertion loss.

## DETERMINING EXPECTED SYSTEM PERFORMANCE

The uncertainty equations and tables of system specifications provided in this chapter can be used to calculate the expected system performance of the analyzer. The following pages explain how to determine the residual errors of a particular system and combine them to obtain total error-corrected residual uncertainty values, using worksheets (Tables 2-4 and 2-5).

Separate tables are used to determine residual magnitude and phase uncertainties in the following measurement types:

- Table 2-4: Reflection measurements
- Table 2-5: Transmission measurements
- Completed examples of the residual uncertainty tables are provided after Table 2-5.

**NOTE:** A spreadsheet program can automate the uncertainty worksheets and eliminate mathematical errors.

### Determining Crosstalk

The crosstalk error value is required in the transmission uncertainty worksheet. You can use the value in Table 2-3 or measure it as explained below:

Connect impedance-matched loads to the reflection and transmission ports. Set IF bandwidth to 10 Hz by pressing **[AVG] [IF BW] [10] [x1]**. Turn on an averaging factor of 5 by pressing **[AVERAGING FACTOR] [5] [x1] [AVERAGING ON]**. Averaging reduces the analyzer's noise floor as explained earlier in this section.

Select a transmission measurement, turn on the marker statistics function (see "Using Markers"), and measure the mean value of the trace. Use the mean value plus one standard deviation as the residual crosstalk value of your system.

Table 2-4. Reflection Measurement Uncertainty Worksheet

**PART A – Analyzer Performance**

Frequency: \_\_\_\_\_

In the columns below, enter the values for each term. Values are obtained from Table 2-3 and Figure 2-1.

Error Term	Symbol	dB Value	Linear Value
Directivity	D		_____
Reflection tracking	T <sub>r</sub>		_____
Source match (reflection)	M <sub>s</sub>		_____
Load match	M <sub>l</sub>		_____
Dynamic accuracy			
Magnitude <sup>1</sup>	A <sub>m</sub>	+ _____	_____
Phase	A <sub>p</sub>		_____
Trace noise	N <sub>h</sub>		_____
Connector repeatability	R <sub>c</sub>		_____

**PART B – DUT Performance**

In the columns below, enter the calculated or measured performance of the DUT.

Performance Parameter	dB Value	Linear Value (10 <sup>dB Value/20</sup> )
S11	_____	_____
S21	_____	_____
S12	_____	_____

**PART C – Total Magnitude Errors (Systematic and Random)**

**Systematic Errors**

In the spaces provided, enter the required linear values from Parts A and B. Then combine these errors to obtain the total sum of systematic errors.

D				=	_____	[k]
T <sub>r</sub> x S11				=	_____	[l]
M <sub>s</sub> x S11 x S11	_____	x	_____	x	_____	= _____ [m]
M <sub>l</sub> x S21 x S12	_____	x	_____	x	_____	= _____ [n]
A <sub>m</sub> x S11				=	_____	[o]
<b>Total Systematic Errors: k + l + m + n + o</b>				=	_____	[S]

**Random Errors**

Enter the required linear values from Parts A and B. Combine these errors in a root sum of the squares (RSS) fashion to obtain a total sum of random errors.

3 x N <sub>h</sub> x S11				=	_____	[x]
R <sub>c</sub> x (1 + 2 S11 + S11 <sup>2</sup> )	_____	x	(1 + 2 x _____ + _____ <sup>2</sup> )	=	_____	[y]
R <sub>c</sub> x S21 x S12	_____	x	_____	x	_____	= _____ [z]

**Total Random Errors**

$$\sqrt{x^2 + y^2 + z^2} \quad \sqrt{\text{_____} + \text{_____} + \text{_____}} = \text{_____} [R]$$

**TOTAL MAGNITUDE ERRORS:**

$$E_m(\text{linear}) = S + R \quad \text{_____} + \text{_____} = \text{_____} [E_m]$$

$$E_m(\text{log}) = 20 \text{ Log} (1 + E_m/S11) \quad 20 \text{ Log} (1 + \text{_____} / \text{_____}) = + \text{_____} \text{ dB}$$

$$20 \text{ Log} (1 - E_m/S11) \quad 20 \text{ Log} (1 - \text{_____} / \text{_____}) = - \text{_____} \text{ dB}$$

**PART D – Total Phase Errors**

$$E_{rp} = \text{Arcsin}[(E_m - (A_m \times S11))/S11] + A_p$$

$$\text{Arcsin}[(\text{_____} - (\text{_____} \times \text{_____})) / \text{_____}] + \text{_____} = \pm \text{_____}^\circ$$

1. Enter the value from Figure 2-1 as a positive dB value. Convert to linear using the formula: Linear Value = 10<sup>dB Value/20</sup> - 1.

Table 2-5. Transmission Measurement Uncertainty Worksheet

**PART A – Analyzer Performance:**

In the columns below, enter the values for each term. Values are obtained from Table 2-3 and Figure 2-1.

Error Term	Symbol	dB Value	Linear Value
Crosstalk <sup>1</sup>	C		_____
Transmission tracking	T <sub>t</sub>		_____
Source match (transmission)	M <sub>s</sub>		_____
Load match	M <sub>l</sub>		_____
Dynamic accuracy			
Magnitude <sup>2</sup>	A <sub>m</sub>	+ _____	_____
Phase	A <sub>p</sub>		_____
Trace noise	N <sub>n</sub>		_____
Connector repeatability	R <sub>c</sub>		_____
Cable Reflection Magnitude			
Stability	S <sub>r</sub>		_____
Cable Transmission Phase			
Stability (Degrees)	S <sub>t</sub>		_____

**PART B – DUT Performance**

In the columns below, enter the calculated or measured performance of the DUT.

Performance Parameter	dB Value	Linear Value (10 <sup>dB Value/20</sup> )
S11	_____	_____
S21	_____	_____
S12	_____	_____
S22	_____	_____

**PART C – Total Magnitude Errors (Systematic and Random)**

**Systematic Errors**

In the spaces provided, enter the required linear values from Parts A and B. Then combine these errors to obtain the total sum of systematic errors.

C = \_\_\_\_\_ [k]  
 T<sub>t</sub> x S21 \_\_\_\_\_ x \_\_\_\_\_ = \_\_\_\_\_ [l]  
 M<sub>s</sub> x S11 x S21 \_\_\_\_\_ x \_\_\_\_\_ = \_\_\_\_\_ [m]  
 (S<sub>r</sub> + M<sub>l</sub>) x S21 x S22 ( \_\_\_\_\_ + \_\_\_\_\_ ) x \_\_\_\_\_ x \_\_\_\_\_ = \_\_\_\_\_ [n]  
 A<sub>m</sub> x S21 \_\_\_\_\_ x \_\_\_\_\_ = \_\_\_\_\_ [o]  
**Total Systematic Errors: k + l + m + n + o = \_\_\_\_\_ [S]**

**Random Errors**

Enter the required linear values from Parts A and B. Combine these errors in a root sum of the squares (RSS) fashion to obtain a total sum of random errors.

3 x N<sub>n</sub> x S21 3x \_\_\_\_\_ x \_\_\_\_\_ = \_\_\_\_\_ [x]  
 R<sub>c</sub> x S21 x (1 + S11) \_\_\_\_\_ x \_\_\_\_\_ x (1 + \_\_\_\_\_) = \_\_\_\_\_ [y]  
 R<sub>c</sub> x S21 x (1 + S22) \_\_\_\_\_ x \_\_\_\_\_ x (1 + \_\_\_\_\_) = \_\_\_\_\_ [z]

**Total Random Errors**

$\sqrt{x^2 + y^2 + z^2}$   $\sqrt{\text{_____} + \text{_____} + \text{_____}}$  = \_\_\_\_\_ [R]

**TOTAL MAGNITUDE ERRORS:**

E<sub>tm</sub>(linear) = S + R \_\_\_\_\_ + \_\_\_\_\_ = \_\_\_\_\_ E<sub>tm</sub>  
 E<sub>tm</sub>(log) = 20 Log (1 + E<sub>tm</sub>/S21) 20 Log (1 + \_\_\_\_\_ / \_\_\_\_\_) = + \_\_\_\_\_ dB  
 20 Log (1 - E<sub>tm</sub>/S21) 20 Log (1 - \_\_\_\_\_ / \_\_\_\_\_) = - \_\_\_\_\_ dB

**PART D – Total Phase Errors**

E<sub>tp</sub> = Arcsin[(E<sub>tm</sub> - (A<sub>m</sub> x S21))/S21] S<sub>t</sub> + A<sub>p</sub>  
 Arcsin[( \_\_\_\_\_ - ( \_\_\_\_\_ x \_\_\_\_\_ ) / \_\_\_\_\_ ] + \_\_\_\_\_ + \_\_\_\_\_ = ± \_\_\_\_\_ °

1. Use the value listed in Table 2-3 or measure (using the instructions provided in "Determining Crosstalk," earlier in this chapter).  
 1. Enter the value from Figure 2-1 as a positive dB value. Convert to linear using the formula: Linear Value = 10<sup>dB Value/20</sup> - 1.

# EXAMPLE

*Table 2-4. Reflection Measurement Uncertainty Worksheet*

**PART A – Analyzer Performance**

Frequency: 1.0 GHz

In the columns below, enter the values for each term. Values are obtained from Table 2-3 and Figure 2-1.

Error Term	Symbol	dB Value	Linear Value
Directivity	D		<u>.01</u>
Reflection tracking	T <sub>r</sub>		<u>.0233</u>
Source match (reflection)	M <sub>s</sub>		<u>.0316</u>
Load match	M <sub>l</sub>		<u>.0718</u>
Dynamic accuracy			
Magnitude <sup>1</sup>	A <sub>m</sub>	<u>+ .05</u>	<u>.0058</u>
Phase	A <sub>p</sub>		<u>.3</u>
Trace noise	N <sub>h</sub>		<u>.0007</u>
Connector repeatability	R <sub>c</sub>		<u>.0006</u>

**PART B – DUT Performance**

In the columns below, enter the calculated or measured performance of the DUT.

Performance Parameter	dB Value	Linear Value (10 <sup>dB Value/20</sup> )
S11	<u>-22</u>	<u>.08</u>
S21	<u>-20</u>	<u>.1</u>
S12	<u>-20</u>	<u>.1</u>

**PART C – Total Magnitude Errors (Systematic and Random)**

**Systematic Errors**

In the spaces provided, enter the required linear values from Parts A and B. Then combine these errors to obtain the total sum of systematic errors.

D			=	<u>.01</u>	[k]
T <sub>r</sub> x S11			=	<u>.001864</u>	[l]
M <sub>s</sub> x S11 x S11	<u>.0316</u>	<u>x .0233</u>	x	<u>.08</u>	= <u>.000202</u> [m]
M <sub>l</sub> x S21 x S12	<u>.0708</u>	<u>x .1</u>	x	<u>.1</u>	= <u>.000708</u> [n]
A <sub>m</sub> x S11		<u>.0058</u>	x	<u>.08</u>	= <u>.000464</u> [o]
<b>Total Systematic Errors: k + l + m + n + o</b>				=	<u>.013238</u> [S]

**Random Errors**

Enter the required linear values from Parts A and B. Combine these errors in a root sum of the squares (RSS) fashion to obtain a total sum of random errors.

3 x N <sub>h</sub> x S11		<u>3x .0007</u>	x	<u>.08</u>	=	<u>.00168</u>	[x]
R <sub>c</sub> x (1 + 2 S11 + S11 <sup>2</sup> )	<u>.0006</u>	<u>x (1 + 2 x .08</u>	<u>+ .08</u>	<u>)</u>	=	<u>.0007</u>	[y]
R <sub>c</sub> x S21 x S12	<u>.0006</u>	<u>x .1</u>	x	<u>.1</u>	=	<u>.000006</u>	[z]

**Total Random Errors**

$$\sqrt{x^2 + y^2 + z^2} = \sqrt{2.822 \times 10^{-6} + 4.9 \times 10^{-7} + 3.6 \times 10^{-11}} = .00182 \text{ [R]}$$

**TOTAL MAGNITUDE ERRORS:**

$$E_{m(\text{linear})} = S + R = .013238 + .00182 = .01506 \text{ [E}_{m}]$$

E <sub>m(log)</sub> = 20 Log (1 + E <sub>m</sub> /S11)	20 Log (1 + <u>.01506 / .08</u> )	= + <u>1.50</u> dB
20 Log (1 - E <sub>m</sub> /S11)	20 Log (1 - <u>.01506 / .08</u> )	= - <u>1.81</u> dB

**PART D – Total Phase Errors**

$$E_{p} = \text{Arcsin}[(E_{m} - (A_m \times S11))/S11] + A_p$$

$$\text{Arcsin}[(.01506 - (.0058 \times .08)) / .08] + .3 = \pm 10.8^\circ$$

1. Enter the value from Figure 2-1 as a positive dB value. Convert to linear using the formula: Linear Value = 10<sup>dB value/20</sup> - 1.

# EXAMPLE

Table 2-5. Transmission Measurement Uncertainty Worksheet

**PART A – Analyzer Performance:** Frequency 1.0 GHz

In the columns below, enter the values for each term. Values are obtained from Table 2-3 and Figure 2-1.

Error Term	Symbol	dB Value	Linear Value
Crosstalk <sup>1</sup>	C		<u>.00001</u>
Transmission tracking	T <sub>t</sub>		<u>.0233</u>
Source match (transmission)	M <sub>s</sub>		<u>.0708</u>
Load match	M <sub>l</sub>		<u>.0708</u>
Dynamic accuracy			
Magnitude <sup>2</sup>	A <sub>m</sub>	<u>+ .05</u>	<u>.0058</u>
Phase	A <sub>p</sub>		<u>.3</u>
Trace noise	N <sub>h</sub>		<u>.0007</u>
Connector repeatability	R <sub>c</sub>		<u>.0006</u>
Cable Reflection Magnitude			
Stability	S <sub>r</sub>		<u>.001</u>
Cable Transmission Phase			
Stability (Degrees)	S <sub>t</sub>		<u>.05</u>

**PART B – DUT Performance**

In the columns below, enter the calculated or measured performance of the DUT.

Performance Parameter	dB Value	Linear Value (10 <sup>dB Value/20</sup> )
S11	<u>-22</u>	<u>.08</u>
S21	<u>-20</u>	<u>.1</u>
S12	<u>-20</u>	<u>.1</u>
S22	<u>-23</u>	<u>.071</u>

**PART C – Total Magnitude Errors (Systematic and Random)**

**Systematic Errors**

In the spaces provided, enter the required linear values from Parts A and B. Then combine these errors to obtain the total sum of systematic errors.

C = .00001 [K]

T<sub>t</sub> x S21 = .0233 x .1 = .00233 [I]

M<sub>s</sub> x S11 x S21 = .0708 x .08 x .1 = .000566 [m]

(S<sub>r</sub> + M<sub>l</sub>) x S21 x S22 = (.001 + .0708) x .1 x .071 = .00051 [n]

A<sub>m</sub> x S21 = .0058 x .1 = .00058 [o]

**Total Systematic Errors: k + l + m + n + o = .004 [S]**

**Random Errors**

Enter the required linear values from Parts A and B. Combine these errors in a root sum of the squares (RSS) fashion to obtain a total sum of random errors.

3 x N<sub>h</sub> x S21 = 3x .0007 x .1 = .00021 [x]

R<sub>c</sub> x S21 x (1 + S11) = .0006 x .1 x (1 + .08) = .00065 [y]

R<sub>c</sub> x S21 x (1 + S22) = .0006 x .1 x (1 + .071) = .00064 [z]

**Total Random Errors**

$\sqrt{x^2 + y^2 + z^2}$  =  $\sqrt{4.41 \times 10^{-8} + 4.2 \times 10^{-9} + 4.129 \times 10^{-9}}$  = .000229 [R]

**TOTAL MAGNITUDE ERRORS:**

E<sub>tm</sub>(linear) = S + R = .004 + .000229 = .004229 E<sub>tm</sub>

E<sub>tm</sub>(log) = 20 Log (1 + E<sub>tm</sub>/S21) = 20 Log (1 + .004229 / .1) = + .36 dB

20 Log (1 - E<sub>tm</sub>/S21) = 20 Log (1 - .004229 / .1) = - .38 dB

**PART D – Total Phase Errors**

E<sub>ip</sub> = Arcsin[(E<sub>tm</sub> - (A<sub>m</sub> x S21))/S21] S<sub>t</sub> + A<sub>p</sub>

Arcsin[(.004229 - (.0058 x .1)) / .1] + .05 + .3 = ± 2.44°

1. Use the value listed in Table 2-3 or measure (using the instructions provided in "Determining Crosstalk," earlier in this chapter).  
 1. Enter the value from Figure 2-1 as a positive dB value. Convert to linear using the formula: Linear Value = 10<sup>dB Value/20</sup> - 1.

## REFLECTION UNCERTAINTY EQUATIONS

This page shows how  $E_{rm}$  is derived from analysis of the system error model shown in Figure 2-3.

### Total Reflection Magnitude Uncertainty ( $E_{rm}$ )

An analysis of the error model (Figure 2-3) yields an equation for the reflection magnitude uncertainty. The equation contains all of the first order terms and the significant second order terms. The three terms under the radical are random and are combined on a root sum of the squares (RSS) basis. The terms in the systematic error group are combined on a worst case basis. In all cases, the error terms and the S-parameters are treated as linear absolute magnitudes.

$$E_{rm}(\log) = 20\log(1 \pm E_{rm}/S_{11})$$

where

$$E_{rm} = S_r + \sqrt{X_r^2 + Y_r^2 + Z_r^2}$$

$$S_r = \text{systematic error} = D + T_r \times S_{11} + M_s \times S_{11}^2 + M_l \times S_{21} \times S_{12} + A_m \times S_{11}$$

$$X_r = \text{random trace noise} = 3 \times N_h \times S_{11}$$

$$Y_r = \text{random port 1 repeatability} = R_c \times (1 + 2 S_{11} + S_{11}^2)$$

$$Z_r = \text{random port 2 repeatability} = R_c \times S_{21} \times S_{12}$$

### Total Reflection Phase Uncertainty ( $E_{rp}$ )

Reflection phase uncertainty is determined from a comparison of the magnitude uncertainty with the test signal magnitude. The worst case phase angle is computed. The result is combined with phase dynamic accuracy.

$$E_{rp} = \arcsin((E_{rm} - A_m \times S_{11})/S_{11}) + A_p$$



## TRANSMISSION UNCERTAINTY EQUATIONS

This page shows how  $E_{tm}$  is derived from analysis of the system error model shown in Figure 2-3.

### Total Transmission Magnitude Uncertainty ( $E_{tm}$ )

An analysis of the error model in Figure 2-3 yields an equation for the transmission magnitude uncertainty. The equation contains all of the first order terms and some of the significant second order terms. The three terms under the radical are random and are combined on an RSS basis. The terms in the systematic error group are combined on a worst case basis. In all cases, the error terms are treated as linear absolute magnitudes.

$$E_{tm} (\log) = 20 \log (1 \pm E_{tm} / S21)$$

where

$$E_{tm} = S_t + \sqrt{X_t^2 + Y_t^2 + Z_t^2}$$

$$S_t = \text{systematic error} = C + T_t \times S21 + M_s \times S11 \times S21 + (M_l + S_r) \times S21 \times S22 + A_m \times S21$$

$$X_t = \text{random high-level noise} = 3 \times N_h \times S21$$

$$Y_t = \text{random port 1 repeatability} = R_c \times S21 + R_c \times S11 \times S21$$

$$Z_t = \text{random port 2 repeatability} = R_c \times S21 + R_c \times S22 \times S21$$

### Total Transmission Phase Uncertainty ( $E_{tp}$ )

Transmission phase uncertainty is calculated from a comparison of the magnitude uncertainty with the test signal magnitude. The worst case phase angle is computed. This result is combined with the error terms related to phase dynamic accuracy, cable phase stability, and thermal drift of the total system.

$$E_{tp} = \arcsin ((E_{tm} - A_m \times S21) / S21) + S_t + A_p$$

# Chapter 3. HP-IB Remote Programming

---

## CHAPTER CONTENTS

- 3-1 Introduction
- 3-2 How HP-IB Works
- 3-3 HP-IB Bus Structure
- 3-5 HP-IB Requirements
- 3-5 Analyzer HP-IB Capabilities
- 3-6 Bus Mode
- 3-7 Setting Addresses
- 3-7 Valid Characters
- 3-7 Code Naming Convention
- 3-8 Units and Terminators
- 3-8 HP-IB Debug Mode
- 3-8 Display Graphics

## INTRODUCTION

The analyzer is factory-equipped with a remote programming digital interface using the Hewlett-Packard Interface Bus (HP-IB). (HP-IB is Hewlett-Packard's hardware, software, documentation, and support for IEEE 488.1 and IEC-625, worldwide standards for interfacing instruments.) This allows the analyzer to be controlled by an external computer that sends commands or instructions to and receives data from the analyzer using the HP-IB. In this way, a remote operator has the same control of the instrument available to a local operator from the front panel, except for control of the line power switch.

In addition, the analyzer itself can use HP-IB to directly control compatible peripherals, without the use of an external controller. It can output measurement results directly to a compatible printer or plotter, or store instrument states to a compatible disk drive.

This chapter provides an overview of HP-IB operation. Chapter 10 provides information on different controller modes, and on setting up the analyzer as a controller of peripherals. It also explains how to use the analyzer as a controller to print, plot, and store to an external disk. HP-IB equivalent mnemonics for front panel functions are provided in parentheses throughout this manual.

More complete information on programming the analyzer remotely over HP-IB is provided in the following documents:

- *HP-IB Programming Guide for the HP 8752A and HP 8753C Using the HP 9000 Series 200/300 Desktop Computer (BASIC)*. This is a tutorial introduction to remote operation of the analyzer using an HP 9000 series 200 or 300 computer. It includes examples of remote measurements using BASIC programming. These examples are also stored on the example programs disk provided with the analyzer. The *HP-IB Programming Guide* assumes familiarity with front panel operation of the instrument.

- *HP-IB Quick Reference for the HP 8700-Series Analyzers*. This is a complete reference summary for remote operation of the analyzer with a controller. It includes both functional and alphabetical lists of all analyzer HP-IB commands. This guide is intended for use by those familiar with HP-IB programming and the basic functions of the analyzer.

A complete general description of the HP-IB is available in *Tutorial Description of the Hewlett-Packard Interface Bus*, HP publication 5952-0156. For more information on the IEEE-488.1 standard refer to *IEEE Standard Digital Interface for Programmable Instrumentation*, published by the Institute of Electrical and Electronics Engineers, Inc., 345 East 47th Street, New York, New York 10017.

## HOW HP-IB WORKS

The HP-IB uses a party-line bus structure in which up to 15 devices can be connected on one contiguous bus. The interface consists of 16 signal lines and 8 ground lines in a shielded cable. With this cabling system, many different types of devices including instruments, computers, plotters, printers, and disk drives can be connected in parallel.

Every HP-IB device must be capable of performing one or more of the following interface functions:

### Talker

A talker is a device capable of sending device-dependent data when addressed to talk. There can be only one talker at any given time. Examples of this type of device are voltmeters, counters, and tape readers. The analyzer is a talker when it sends trace data or marker information over the bus.

### Listener

A listener is a device capable of receiving device-dependent data when addressed to listen. There can be any number of listeners at any given time. Examples of this type of device are printers, power supplies, and signal generators. The analyzer is a listener when it is controlled over the bus by a computer.

### Controller

A controller is a device capable of managing the operation of the bus and addressing talkers and listeners. There can be only one active controller at any time. Examples of controllers include desktop computers and minicomputers. In a multiple-controller system, active control can be passed between controllers, but there can only be one *system controller*, which acts as the master, and can regain active control at any time. The analyzer is an active controller when it plots, prints, or stores to an external disk drive in the pass control mode. The analyzer is a system controller when it is in the system controller mode. These modes are discussed in more detail in Chapter 10 under *HP-IB Menu*.

## HP-IB BUS STRUCTURE

### Data Bus

The data bus consists of eight bidirectional lines that are used to transfer data from one device to another. Programming commands and data are typically encoded on these lines in ASCII, although binary encoding is often used to speed up the transfer of large arrays. Both ASCII and binary data formats are available to the analyzer. In addition, every byte transferred over HP-IB undergoes a *handshake* to ensure valid data.

### Handshake Lines

A three-line handshake scheme coordinates the transfer of data between talkers and listeners. This technique forces data transfers to occur at the speed of the slowest device, and ensures data integrity in multiple listener transfers. With most computing controllers and instruments, the handshake is performed automatically, which makes it transparent to the programmer.

### Control Lines

The data bus also has five control lines that the controller uses both to send bus commands and to address devices.

**IFC.** Interface Clear. Only the system controller uses this line. When this line is true (low), all devices (addressed or not) unaddress and go to an idle state.

**ATN.** Attention. The active controller uses this line to define whether the information on the data bus is a *command* or is *data*. When this line is true (low), the bus is in the command mode and the data lines carry bus commands. When this line is false (high), the bus is in the data mode and the data lines carry device-dependent instructions or data.

**SRQ.** Service Request. This line is set true (low) when a device requests service: the active controller services the requesting device. The analyzer can be enabled to pull the SRQ line for a variety of reasons.

**REN.** Remote Enable. Only the system controller uses this line. When this line is set true (low), the bus is in the remote mode, and devices are addressed either to listen or to talk. When the bus is in remote and a device is addressed, it receives instructions from HP-IB rather than from its front panel (the **[LOCAL]** key returns the device to front panel operation). When this line is set false (high), the bus and all devices return to local operation.

**EOI.** End or Identify. This line is used by a talker to indicate the last data byte in a multiple byte transmission, or by an active controller to initiate a parallel poll sequence. The analyzer recognizes the EOI line as a terminator, and it pulls the EOI line with the last byte of a message output (data, markers, plots, prints, error messages). The analyzer does not respond to parallel poll.

Figure 3-1 illustrates the structure of the HP-IB bus lines.

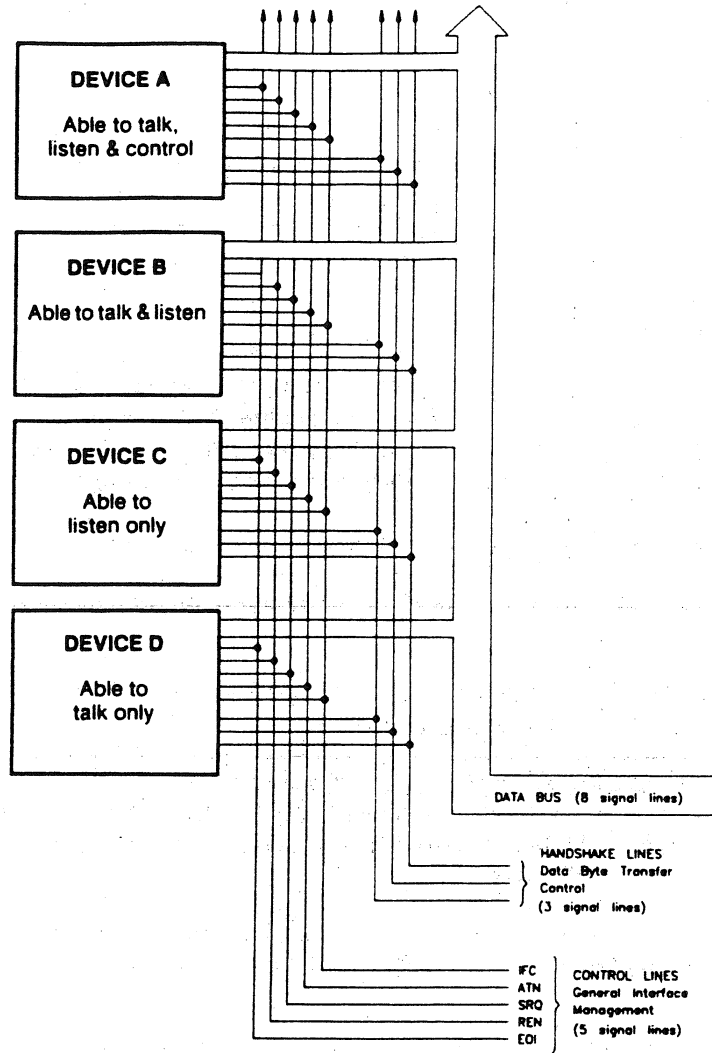

Figure 3-1. HP-IB Structure

## HP-IB REQUIREMENTS

<b>Number of Interconnected Devices:</b>	15 maximum.
<b>Interconnection Path/ Maximum Cable Length:</b>	20 meters maximum or 2 meters per device, whichever is less.
<b>Message Transfer Scheme:</b>	Byte serial/ bit parallel asynchronous data transfer using a 3-line handshake system.
<b>Data Rate:</b>	Maximum of 1 megabyte per second over limited distances with tri-state drivers. Actual data rate depends on the transfer rate of the slowest device involved.
<b>Address Capability:</b>	Primary addresses: 31 talk, 31 listen. A maximum of 1 talker and 14 listeners at one time.
<b>Multiple Controller Capability:</b>	In systems with more than one controller (like the analyzer system), only one can be active at a time. The active controller can pass control to another controller, but only the system controller can assume unconditional control. Only one system controller is allowed. The system controller is hard-wired to assume bus control after a power failure.

## ANALYZER HP-IB CAPABILITIES

As defined by the IEEE 488.1 standard, the analyzer has the following capabilities:

<b>SH1</b>	Full source handshake.
<b>AH1</b>	Full acceptor handshake.
<b>T6</b>	Basic talker, answers serial poll, unaddresses if MLA is issued. No talk-only mode.
<b>L4</b>	Basic listener, unaddresses if MTA is issued. No listen-only mode.
<b>SR1</b>	Complete service request (SRQ) capabilities.
<b>RL1</b>	Complete remote/local capability including local lockout.
<b>PP0</b>	Does not respond to parallel poll.
<b>DC1</b>	Complete device clear.
<b>DT1</b>	Responds to a group execute trigger in the hold trigger mode.
<b>C1,C2,C3</b>	System controller capabilities in system controller mode.
<b>C10</b>	Pass control capabilities in pass control mode.
<b>E2</b>	Tri-state drivers.

## BUS MODE

The analyzer uses a single-bus architecture. The single bus allows both the analyzer and the host controller to have complete access to the peripherals in the system.

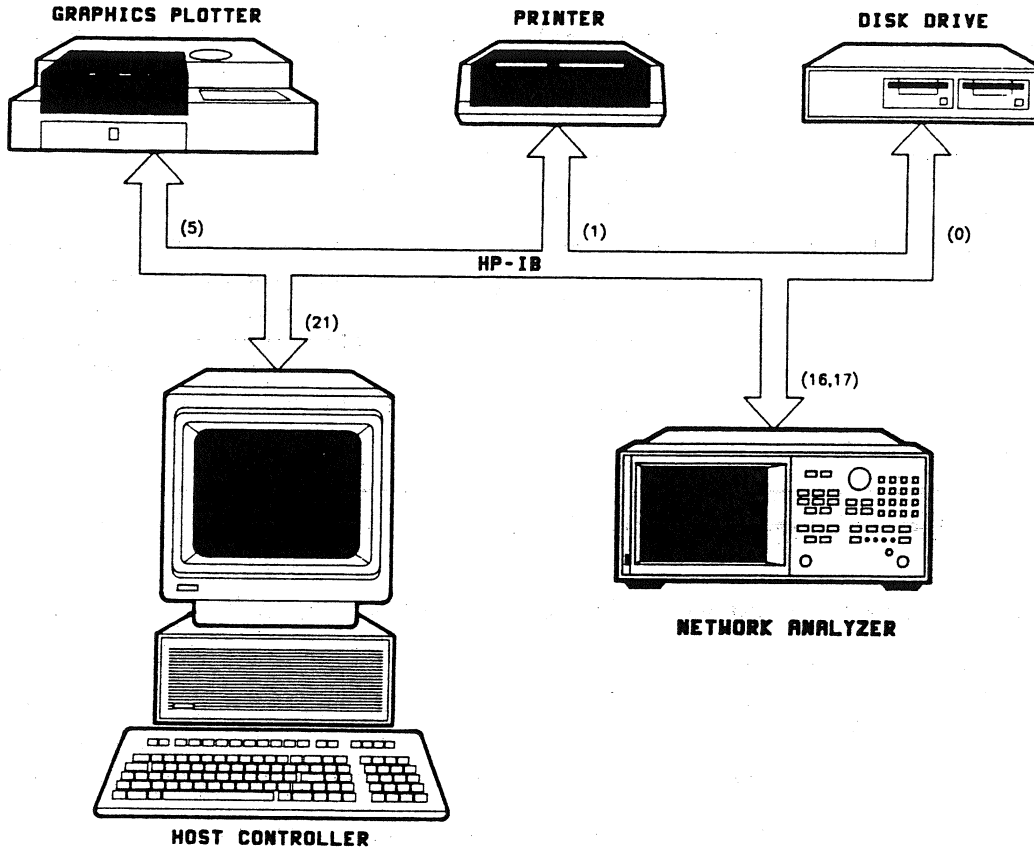

Figure 3-2. Analyzer Single Bus Concept

Three different controller modes are possible, system controller, talker/listener, and pass control.

**System Controller.** This mode allows the analyzer to control peripherals directly in a stand-alone environment (without an external controller). This mode can only be selected manually from the analyzer front panel. Use this mode for operation when no computer is connected to the analyzer. Do not use this mode for programming.

**Talker/Listener.** This is the traditional programming mode, in which the computer is involved in all peripheral access operations. Peripheral access (plotting and printing only) is also possible by addressing the analyzer to talk, addressing the peripheral to listen, and placing the HP-IB in the data mode.

**Pass Control.** This mode allows you to control the analyzer over HP-IB as with the talker/listener mode, and also allows the analyzer to take or pass control in order to plot, print, and access a disk. During the peripheral operation, the host computer is free to perform other internal tasks such as data or display manipulation (the bus is tied up by the analyzer during this time). After a task is completed, the host controller accepts control again when the analyzer returns it.

In general, use the talker/listener mode for programming the analyzer unless you desire direct peripheral access. Preset does not affect the selected bus mode, but the bus mode returns talker/listener if power is cycled.

Chapter 10 explains the three different bus modes in detail, and provides information on setting the correct bus mode. Programming information for talker/listener mode and pass control mode is provided in the *HP-IB Programming Guide*.

## SETTING ADDRESSES

In communications through HP-IB, each instrument on the bus is identified by an HP-IB address. This address code must be different for each instrument on the bus. Refer to *Address Menu* in Chapter 10 for information on default addresses, and on setting and changing addresses. These addresses are not affected when you press **[PRESET]** or cycle the power (although the **[PRESET]** key must be pressed to implement a change to the analyzer address).

## VALID CHARACTERS

The analyzer accepts ASCII letters, numbers, decimal points, +/−, semicolons, quotation marks (“”), carriage returns (CR), and linefeeds (LF). Both upper and lower case are acceptable. Leading zeros, spaces, carriage returns, and unnecessary terminators are ignored, except those within a command or appendage. Carriage returns are ignored. An invalid character causes a syntax error. Syntax errors are described in more detail under in the *HP-IB Programming Guide*.

## CODE NAMING CONVENTION

The analyzer HP-IB commands are derived from their front panel key titles (where possible), according to the naming convention below.

Convention	Key Title	For HP-IB Code Use	Example
One Word	Power Start	First Four Letters	POWE STAR
Two Words	Electrical Delay Search Right	First Three Letters of First Word First Letter of Second Word	ELED SEAR
Two Words in a Group	Marker →Center Gate →Span	First Four Letters of Both	MARKCENT GATESPAN
Three Words	Cal Kit N 50Ω Pen Num Data	First Three Letters of First Word First Letter of Second Word First Four Letters of Third Word	CALKN50 PENNDATA

Some codes require appendages (on, off, 1, 2, etc.). Codes that have no front panel equivalent are HP-IB only commands, and use a similar convention based on the common name of the function. Where possible, analyzer codes are compatible with HP 8510A/B codes.

Front panel equivalent codes and HP-IB only codes are summarized in the *HP-IB Quick Reference*.



## UNITS AND TERMINATORS

The analyzer outputs data in basic units and assumes these basic units when it receives an input, unless the input is otherwise qualified. The basic units and allowable expressions follow; either upper or lower case is acceptable.

Basic Units	Allowable Expressions
Seconds	S
Milliseconds	MS
Microseconds	US
Nanoseconds	NS
Picoseconds	PS
Femtoseconds	FS
Hertz	HZ
Kilohertz	KHZ
Megahertz	MHZ
Gigahertz	GHZ
dB or dBm	DB
Volts	V

Terminators are used to indicate the end of a command to allow the analyzer to recover to the next command in the event of a syntax error. The semicolon is the recommended command terminator. The line feed (LF) character and the HP-IB EOI line can also be used as terminators. The analyzer ignores the carriage return (CR) character.

## HP-IB DEBUG MODE

An HP-IB diagnostic feature (debug mode) is available in the HP-IB menu. Activating the debug mode causes the analyzer to scroll incoming HP-IB commands across the display. Nonprintable characters are represented with a  $\pi$ . Any time the analyzer receives a syntax error, the commands halt, and a pointer  $\wedge$  indicates the misunderstood character. The *HP-IB Programming Guide* explains how to clear a syntax error.

## DISPLAY GRAPHICS

The analyzer display can be used as a graphics display for displaying connection diagrams or custom instructions to an operator. The display accepts a subset of Hewlett-Packard Graphics Language (HP-GL) commands issued by an external computer. Some user graphics can be created using the test sequencing feature.

**NOTE:** The analyzer display occupies an additional address on the HP-IB. Determine the display bus address by adding 1 to the analyzer address (if the analyzer address is an even number), or subtracting 1 (if it is an odd number). Thus the factory default display address for graphics is 17.

# HP-IB Programming Guide



For the HP 8752A and HP 8753C Network Analyzers with the HP 9000 series 200/300 desktop computer (BASIC)

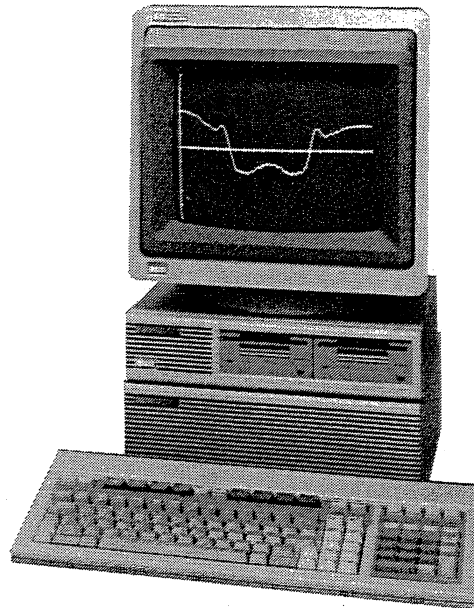
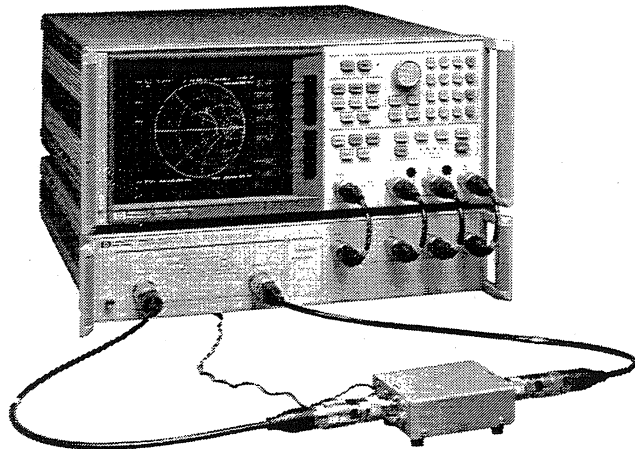

## Introduction

This programming guide is an introduction to remote operation of the HP 8752A and 8753C Network Analyzers using an HP 9000 series 200 or 300 computer. It is a tutorial introduction, using BASIC programming examples. The examples are on the Example Programs disk (part number 08753-10014), included with the operating manual. This document is closely associated with the HP-IB Quick Reference for the HP 8700-series network analyzers. The *HP-IB Quick Reference* provides complete programming information in a concise format. Included in the *HP-IB Quick Reference* are both functional and alphabetical lists of HP-IB commands. The *Quick Reference* also lists HP-IB commands, along with its softkey menu explanations.

The Hewlett-Packard computers specifically addressed are the HP 9000 series 200 and 300 computers, operating with BASIC 2.0 with AP2\_1, or BASIC 3.0 or higher. This includes the 216 (9816), 217 (9817), 220 (9920), 226 (9826), 236 (9836), 310 and 320 computers.

The reader should become familiar with the operation of the network analyzer before controlling it over HP-IB. This document is not intended to teach BASIC programming or to discuss HP-IB theory except at an introductory level: read "For more information," next, for documents better suited to these tasks.

## For more information

For more information concerning the operation of the network analyzer, refer to the following:

*User's Guide*  
*Quick Reference*  
*Operating Manual*

For more information concerning BASIC, see the manual set for the BASIC revision being used. For example:

*BASIC 5.0 Programming Techniques* 98613-90012  
*BASIC 5.0 Language Reference* 98613-90052

For more information concerning HP-IB, see:

*BASIC 5.0 Interfacing Techniques* 98613-90022  
*Tutorial Description of the Hewlett-Packard Interface Bus* 5952-0156  
*Condensed Description of the Hewlett-Packard Interface Bus* 59401-90030

## Table of contents

Basic Instrument Control .....	3
Measurement Programming .....	6
Basic Programming Examples:	
1. Setting up a basic measurement .....	8
Performing a measurement calibration:	
2A. S11 1-port calibration .....	10
2B. Full 2-port calibration (HP 8753C) .....	12
Data transfer from analyzer to computer:	
3A. Data transfer using ASCII transfer format .....	
3B. Data transfer using IEEE 64 bit floating point format .....	21
3C. Data transfer using the network analyzer internal binary format .....	
Advanced Programming Examples:	
Using list frequency mode:	
4A. Setting up a list frequency sweep .....	25
4B. Selecting a single segment from a table of segments .....	28
Using limit lines to perform limit testing:	
5A. Setting up limit lines .....	30
5B. Performing PASS/FAIL tests while tuning .....	33
Storing and recalling instrument states:	
6A. Using the learn string .....	35
6B. Coordinating disk storage .....	
6C. Reading calibration data .....	37
Miscellaneous Programming Examples:	
Controlling peripherals:	
7. Operation using pass control mode .....	39
8. Creating a user interface .....	41
Transferring disk data files:	
9. Reading data files into a computer .....	45
Appendix A: Status Reporting .....	47
A1. Using the error queue .....	47
A2. Using the status registers .....	49
A3. Using the preset bit .....	50
A4. Generating interrupts .....	51

## Required equipment

To run the examples of this *Programming Guide*, the following equipment is required:

1. HP 8752A or 8753C Network Analyzer.
2. HP 9000 series 200 or 300 computer with enough memory to hold BASIC, needed binaries, and at least 64 kBytes of program space. In addition, 512 kBytes are needed for BASIC 3.0 or higher operating systems, with the binaries suggested in step 2 in the section Powering up the system. A disk drive (e.g. HP 9122) is required to load BASIC if no internal disk drive is available.
3. HP BASIC 2.0 with AP2-1, or BASIC 3.0 or higher operating system.
4. HP 10833A/B/C/D HP-IB cables to interconnect the computer, the network analyzer, and any peripherals.

Microsoft® is a U.S. registered trademark of Microsoft Corporation.  
MS-DOS® is a U.S. registered trademark of Microsoft Corporation.

## Optional equipment

1. HP 85032B 50 ohm type-N calibration kit.
2. HP 11852D test port return cables.
3. A test device such as a filter to use in the example measurement programs.
4. HP 7440A ColorPro plotter, an HP 2225A Thinkjet printer, or an HP 9122 or HP 9153 CS80 disk drive. See the General Information section of the manual for a more complete list of compatible peripherals.

## Using other computers

Although the examples in this guide apply only to the equipment listed above, other computers can control the network analyzer.

- HP VECTRA Personal Computer using an HP 82300 BASIC Language Processor.
- MS-DOS® compatible computer (PC) with HP 82990A "HP-IB Interface and Command Library". Microsoft® Quick BASIC 4.0 is fully compatible with the HP 82990A.

## Powering up the system

1. **Set up the network analyzer as shown in Figure 1.** Connect the network analyzer to the computer with an HP-IB cable. The network analyzer has only one HP-IB interface, but it occupies two addresses: one for the instrument, one for the display. The display address is the instrument address with the least significant bit complemented. The default addresses are 16 for the instrument, 17 for the display. Devices on the HP-IB cannot occupy the same address as the network analyzer.
2. **Turn on the computer and load the BASIC operating system.** For BASIC 2.0, load AP2-1 if available. If BASIC 3.0 or higher is used, load the following BASIC binary extensions: HPIB, GRAPH, IO, KBD, and ERR. Depending on the disk drive, a binary such as CS80 may be also required.
3. **Turn the network analyzer on.** To verify the network analyzer's address, press [LOCAL] [SET ADDRESSES] and [ADDRESS: 875x]. If the address has been changed from the default value (16), return it to 16 while performing the examples in this document by pressing [1] [6] [x1] and then presetting the instrument. Make sure the instrument is in either [USE PASS CONTROL] or [TALKER/LISTENER] mode, as indicated under the [LOCAL] key. These are the only modes in which the network analyzer will accept commands over HP-IB.
4. **On the computer, type the following:** OUTPUT 716; "PRES; "[EXECUTE] or [RETURN]) This will preset the network analyzer. If Preset does not occur, there is a problem. First check all HP-IB addresses and connections: most HP-IB problems are caused by an incorrect address and bad or loose HP-IB cables.

**NOTE:** Only the 9826 and 9836 computers have an [EXECUTE] key. The HP 216 has an [EXEC] key with the same function. All other computers use the [RETURN] key as both execute and enter. The notation [EXECUTE] is used in this document.

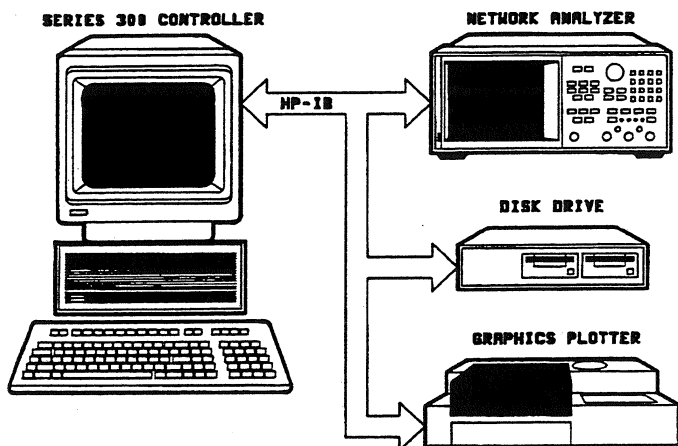

Figure 1. HP-IB connections in a typical setup.

## Basic Instrument Control

A computer controls the network analyzer by sending it commands over HP-IB. The commands are specific to the network analyzer. Each command is executed automatically, taking precedence over manual control of the network analyzer. A command applies only to the active channel except where functions are coupled between channels, just as with front panel operation. Most commands are equivalent to front panel functions. For example, type:

OUTPUT 716;"STAR 10 MHZ;" and press [EXECUTE].

The network analyzer now has a start frequency of 10 MHz. The construction of the command is:

OUTPUT 716;"STAR 10 MHZ;"

The BASIC data output statement. The data is directed to interface 7 (HP-IB), and on out to the device at address 16 (the network analyzer).

The network analyzer mnemonic for setting the start frequency. The mnemonic, less the quotation marks, is sent literally by the OUTPUT statement, followed by a carriage return, line feed.

The STAR 10 MHZ; command performs the same function as pressing [START] and keying in 10 [M/u]. STAR is the root mnemonic for the start key, 10 is the data, and MHZ are the units. The network analyzer's root mnemonics are derived from the equivalent key label where possible, otherwise from the common name for the function. The *HP-IB Quick Reference* lists all the root mnemonics, and all the different units accepted.

The semicolon following MHZ terminates the command inside the network analyzer. It removes start frequency from the active entry area, and prepares the network analyzer for the next command. If there is a syntax error in a command, the network analyzer will ignore the command and look for the next terminator. When it finds the next terminator, it starts processing incoming commands normally. Characters between the syntax error and the next terminator are lost. A line feed also acts as terminator. The BASIC OUTPUT statement transmits a carriage return, line feed following the data. This can be suppressed by putting a semicolon at the end of the statement.

The OUTPUT 716; statement will transmit all items listed, as long as they are separated by commas or semicolons. It will transmit literal information enclosed in quotes, numeric variables, string variables, and arrays. A carriage return, line feed is transmitted after each item. This can be stopped by separating items with semicolons instead of commas.

The front panel remote (R) and listen (L) HP-IB status indicators are on. The network analyzer automatically goes into remote mode when sent a command with the OUTPUT statement. In remote mode, the network analyzer ignores all front panel keys except the local key. Pressing the [LOCAL] key returns the network analyzer to manual operation, unless the universal HP-IB command LOCAL LOCKOUT 7 has been issued. The only way to get out of local lockout is to issue the LOCAL 7 command, or cycle power on the network analyzer.

Setting a parameter is one form of command the network analyzer will accept. It will also accept simple commands that require no operand. For example, execute:

OUTPUT 716;"AUTO;"

In response, the network analyzer autoscales the active channel. Autoscale only applies to the active channel, unlike start frequency, which applies to both channels as long as the channels are stimulus coupled.

The network analyzer will also accept commands that turn various functions on and off. Execute:

OUTPUT 716;"DUACON;"

This causes the network analyzer to display both channels. To go back to single channel display mode, execute:

OUTPUT 716;"DUACOFF;"

The construction of the command starts with the root mnemonic DUAC (dual channel display,) and ON or OFF appended to the root to form the entire command.

The network analyzer does not distinguish between upper and lower case letters. For example, execute:

OUTPUT 716;"auto;" The network analyzer also has a debug mode to aid in trouble-shooting systems. When debug mode is on, thenetwork analyzer scrolls incoming HP-IB commands across the display. To turn the mode on manually, press [LOCAL] [HP-IB DIAG ON]. To turn it on over HP-IB, execute:

OUTPUT 716;"DEBUON;"

## Command interrogate

Suppose the operator has changed the power level from the front panel. The computer can find the new level by using the network analyzer's command interrogate function. If a question mark is appended to the root of a command, the network analyzer will output the value of that function. For instance, `POWE 5 DB;` sets the output power to 5 dB, and `POWE?;` outputs the current RF output power at the test port. For example, type `SCRATCH` and press `[EXECUTE]` to clear old programs. Type `EDIT` and press `[EXECUTE]` to get into the edit mode. Then type in:

```
10 OUTPUT 716;"POWE?;"
20 ENTER 716;Reply
30 DISP Reply
40 END
```

Run the program. The computer will display the source power level in dBm. The preset level is 0 dBm. Change the power level by pressing `[LOCAL] [MENU] [POWER]` and then entering `[1] [x1]`. Run the program again.

When the network analyzer receives `POWE?`, it prepares to transmit the current RF source power level. The BASIC statement `ENTER 716` allows the network analyzer to transmit information to the computer by addressing it to talk. This turns the network analyzer front panel talk light (T) on. The computer places the data transmitted by the network analyzer into the variables listed in the enter statement. In this case, the network analyzer transmits the output power, which gets placed in the variable `Reply`.

The `ENTER` statement takes the stream of binary data output by the network analyzer and reformats it back into numbers and ASCII strings. With the formatting in its default state, the enter statement will format the data into real variables, integers, or ASCII strings, depending on the variable being filled. The variable list must match the data the network analyzer has to transmit: if there are too few variables, data is lost, and if there are too many variables for the data available, a BASIC error is generated.

The formatting done by the enter statement can be changed. As discussed in *Data transfer from analyzer to computer*, the formatting can be turned off to allow binary transfers of data. Also, the `ENTER USING` statement can be used to selectively control the formatting.

On/off commands can be also be interrogated. The reply is a one if the function is on, a zero if it is off. Similarly, if a command controls a function that is underlined on the network analyzer display when active, interrogating that command yields a one if the command is underlined, a zero if it is not. For example, there are nine options on the format menu: only one is underlined at a time. The underlined option will return a one when interrogated.

For instance, rewrite line 10 as:

```
10 OUTPUT 716;"DUAC?;"
```

Run the program once, note the result, then press `[LOCAL] [DISPLAY] [DUAL CHAN]` to toggle the display mode, and run the program again.

Another example is to rewrite line 10 as:

```
10 OUTPUT 716;"PHAS?;"
```

In this case, the program will display a one if phase is currently being displayed. Since the command only applies to the active channel, the response to the `PHAS?` inquiry depends on which channel is active.

## Held commands

When the network analyzer is executing a command that cannot be interrupted, it will hold off processing new HP-IB commands. It will fill the 16 character input buffer, and then halt HP-IB until the held command has completed execution. This action will be clear to a programmer unless HP-IB timeouts have been set with the `ON TIMEOUT` statement.

While a held command is executing, the network analyzer will still service the HP-IB interface commands, such as `SPOLL(716)`, `CLEAR 716`, and `ABORT 7`. Executing `CLEAR 716` or `CLEAR 7` will abort a command hold off, leaving the held command to complete execution as if it had been begun from the front panel. These commands also clear the input buffer, destroying any commands received after the held command. If the network analyzer has halted the bus because its input buffer was full, `ABORT 7` will release the bus.

## Operation complete

Occasionally, there is a need to find out when certain operations have completed inside the network analyzer. For instance, a program should not have the operator connect the next calibration standard while the network analyzer is still measuring the current one.

To provide such information, the network analyzer has an Operation Complete reporting mechanism that will indicate when certain key commands have completed operation. The mechanism is activated by sending either `OPC` or `OPC?` immediately before an OPC'able command. When the command completes execution, bit 0 of the event status register will be set. If `OPC` was interrogated with `OPC?`, the network analyzer will output a 1 when the command completes execution.

# Chapter 3. HP-IB Remote Programming

---

## CHAPTER CONTENTS

3-1	Introduction
3-2	How HP-IB Works
3-3	HP-IB Bus Structure
3-5	HP-IB Requirements
3-5	Analyzer HP-IB Capabilities
3-6	Bus Mode
3-7	Setting Addresses
3-7	Valid Characters
3-7	Code Naming Convention
3-8	Units and Terminators
3-8	HP-IB Debug Mode
3-8	Display Graphics

## INTRODUCTION

The analyzer is factory-equipped with a remote programming digital interface using the Hewlett-Packard Interface Bus (HP-IB). (HP-IB is Hewlett-Packard's hardware, software, documentation, and support for IEEE 488.1 and IEC-625, worldwide standards for interfacing instruments.) This allows the analyzer to be controlled by an external computer that sends commands or instructions to and receives data from the analyzer using the HP-IB. In this way, a remote operator has the same control of the instrument available to a local operator from the front panel, except for control of the line power switch.

In addition, the analyzer itself can use HP-IB to directly control compatible peripherals, without the use of an external controller. It can output measurement results directly to a compatible printer or plotter, or store instrument states to a compatible disk drive.

This chapter provides an overview of HP-IB operation. Chapter 10 provides information on different controller modes, and on setting up the analyzer as a controller of peripherals. It also explains how to use the analyzer as a controller to print, plot, and store to an external disk. HP-IB equivalent mnemonics for front panel functions are provided in parentheses throughout this manual.

More complete information on programming the analyzer remotely over HP-IB is provided in the following documents:

- *HP-IB Programming Guide for the HP 8752A and HP 8753C Using the HP 9000 Series 200/300 Desktop Computer (BASIC)*. This is a tutorial introduction to remote operation of the analyzer using an HP 9000 series 200 or 300 computer. It includes examples of remote measurements using BASIC programming. These examples are also stored on the example programs disk provided with the analyzer. The *HP-IB Programming Guide* assumes familiarity with front panel operation of the instrument.

- *HP-IB Quick Reference for the HP 8700-Series Analyzers*. This is a complete reference summary for remote operation of the analyzer with a controller. It includes both functional and alphabetical lists of all analyzer HP-IB commands. This guide is intended for use by those familiar with HP-IB programming and the basic functions of the analyzer.

A complete general description of the HP-IB is available in *Tutorial Description of the Hewlett-Packard Interface Bus*, HP publication 5952-0156. For more information on the IEEE-488.1 standard refer to *IEEE Standard Digital Interface for Programmable Instrumentation*, published by the Institute of Electrical and Electronics Engineers, Inc., 345 East 47th Street, New York, New York 10017.

## HOW HP-IB WORKS

The HP-IB uses a party-line bus structure in which up to 15 devices can be connected on one contiguous bus. The interface consists of 16 signal lines and 8 ground lines in a shielded cable. With this cabling system, many different types of devices including instruments, computers, plotters, printers, and disk drives can be connected in parallel.

Every HP-IB device must be capable of performing one or more of the following interface functions:

### Talker

A talker is a device capable of sending device-dependent data when addressed to talk. There can be only one talker at any given time. Examples of this type of device are voltmeters, counters, and tape readers. The analyzer is a talker when it sends trace data or marker information over the bus.

### Listener

A listener is a device capable of receiving device-dependent data when addressed to listen. There can be any number of listeners at any given time. Examples of this type of device are printers, power supplies, and signal generators. The analyzer is a listener when it is controlled over the bus by a computer.

### Controller

A controller is a device capable of managing the operation of the bus and addressing talkers and listeners. There can be only one active controller at any time. Examples of controllers include desktop computers and minicomputers. In a multiple-controller system, active control can be passed between controllers, but there can only be one *system controller*, which acts as the master, and can regain active control at any time. The analyzer is an active controller when it plots, prints, or stores to an external disk drive in the pass control mode. The analyzer is a system controller when it is in the system controller mode. These modes are discussed in more detail in Chapter 10 under *HP-IB Menu*.

## HP-IB BUS STRUCTURE

### Data Bus

The data bus consists of eight bidirectional lines that are used to transfer data from one device to another. Programming commands and data are typically encoded on these lines in ASCII, although binary encoding is often used to speed up the transfer of large arrays. Both ASCII and binary data formats are available to the analyzer. In addition, every byte transferred over HP-IB undergoes a *handshake* to ensure valid data.

### Handshake Lines

A three-line handshake scheme coordinates the transfer of data between talkers and listeners. This technique forces data transfers to occur at the speed of the slowest device, and ensures data integrity in multiple listener transfers. With most computing controllers and instruments, the handshake is performed automatically, which makes it transparent to the programmer.

### Control Lines

The data bus also has five control lines that the controller uses both to send bus commands and to address devices.

**IFC.** Interface Clear. Only the system controller uses this line. When this line is true (low), all devices (addressed or not) unaddress and go to an idle state.

**ATN.** Attention. The active controller uses this line to define whether the information on the data bus is a *command* or is *data*. When this line is true (low), the bus is in the command mode and the data lines carry bus commands. When this line is false (high), the bus is in the data mode and the data lines carry device-dependent instructions or data.

**SRQ.** Service Request. This line is set true (low) when a device requests service: the active controller services the requesting device. The analyzer can be enabled to pull the SRQ line for a variety of reasons.

**REN.** Remote Enable. Only the system controller uses this line. When this line is set true (low), the bus is in the remote mode, and devices are addressed either to listen or to talk. When the bus is in remote and a device is addressed, it receives instructions from HP-IB rather than from its front panel (the **[LOCAL]** key returns the device to front panel operation). When this line is set false (high), the bus and all devices return to local operation.

**EOI.** End or Identify. This line is used by a talker to indicate the last data byte in a multiple byte transmission, or by an active controller to initiate a parallel poll sequence. The analyzer recognizes the EOI line as a terminator, and it pulls the EOI line with the last byte of a message output (data, markers, plots, prints, error messages). The analyzer does not respond to parallel poll.

Figure 3-1 illustrates the structure of the HP-IB bus lines.



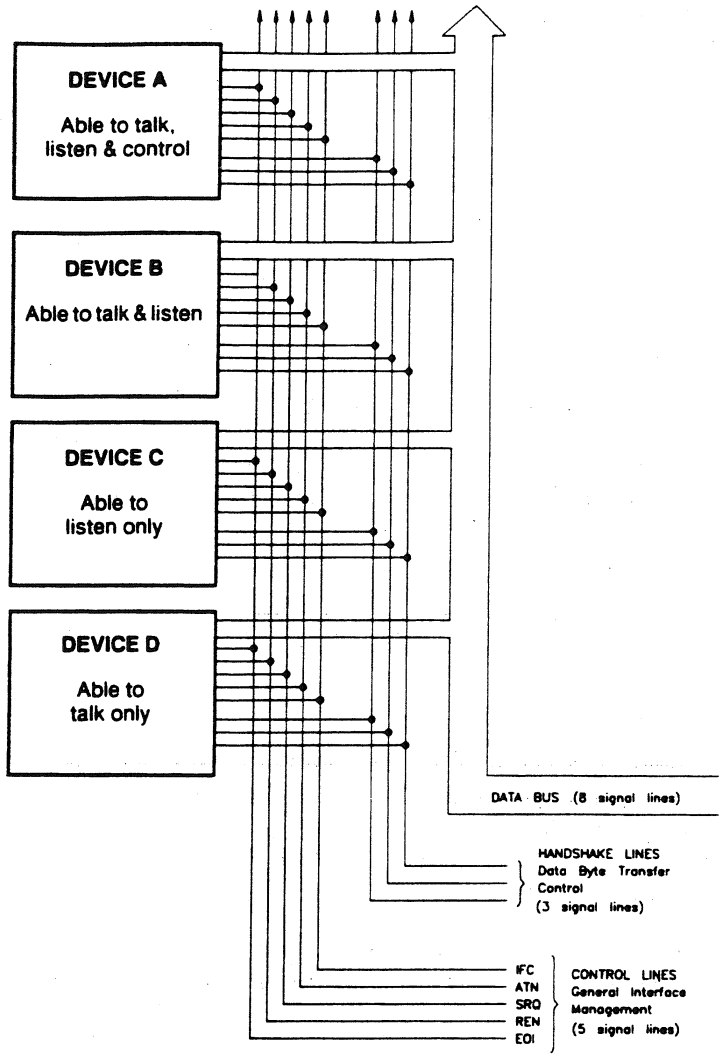

Figure 3-1. HP-IB Structure

## HP-IB REQUIREMENTS

<b>Number of Interconnected Devices:</b>	15 maximum.
<b>Interconnection Path/ Maximum Cable Length:</b>	20 meters maximum or 2 meters per device, whichever is less.
<b>Message Transfer Scheme:</b>	Byte serial/ bit parallel asynchronous data transfer using a 3-line handshake system.
<b>Data Rate:</b>	Maximum of 1 megabyte per second over limited distances with tri-state drivers. Actual data rate depends on the transfer rate of the slowest device involved.
<b>Address Capability:</b>	Primary addresses: 31 talk, 31 listen. A maximum of 1 talker and 14 listeners at one time.
<b>Multiple Controller Capability:</b>	In systems with more than one controller (like the analyzer system), only one can be active at a time. The active controller can pass control to another controller, but only the system controller can assume unconditional control. Only one system controller is allowed. The system controller is hard-wired to assume bus control after a power failure.

## ANALYZER HP-IB CAPABILITIES

As defined by the IEEE 488.1 standard, the analyzer has the following capabilities:

<b>SH1</b>	Full source handshake.
<b>AH1</b>	Full acceptor handshake.
<b>T6</b>	Basic talker, answers serial poll, unaddresses if MLA is issued. No talk-only mode.
<b>L4</b>	Basic listener, unaddresses if MTA is issued. No listen-only mode.
<b>SR1</b>	Complete service request (SRQ) capabilities.
<b>RL1</b>	Complete remote/local capability including local lockout.
<b>PP0</b>	Does not respond to parallel poll.
<b>DC1</b>	Complete device clear.
<b>DT1</b>	Responds to a group execute trigger in the hold trigger mode.
<b>C1,C2,C3</b>	System controller capabilities in system controller mode.
<b>C10</b>	Pass control capabilities in pass control mode.
<b>E2</b>	Tri-state drivers.

## BUS MODE

The analyzer uses a single-bus architecture. The single bus allows both the analyzer and the host controller to have complete access to the peripherals in the system.

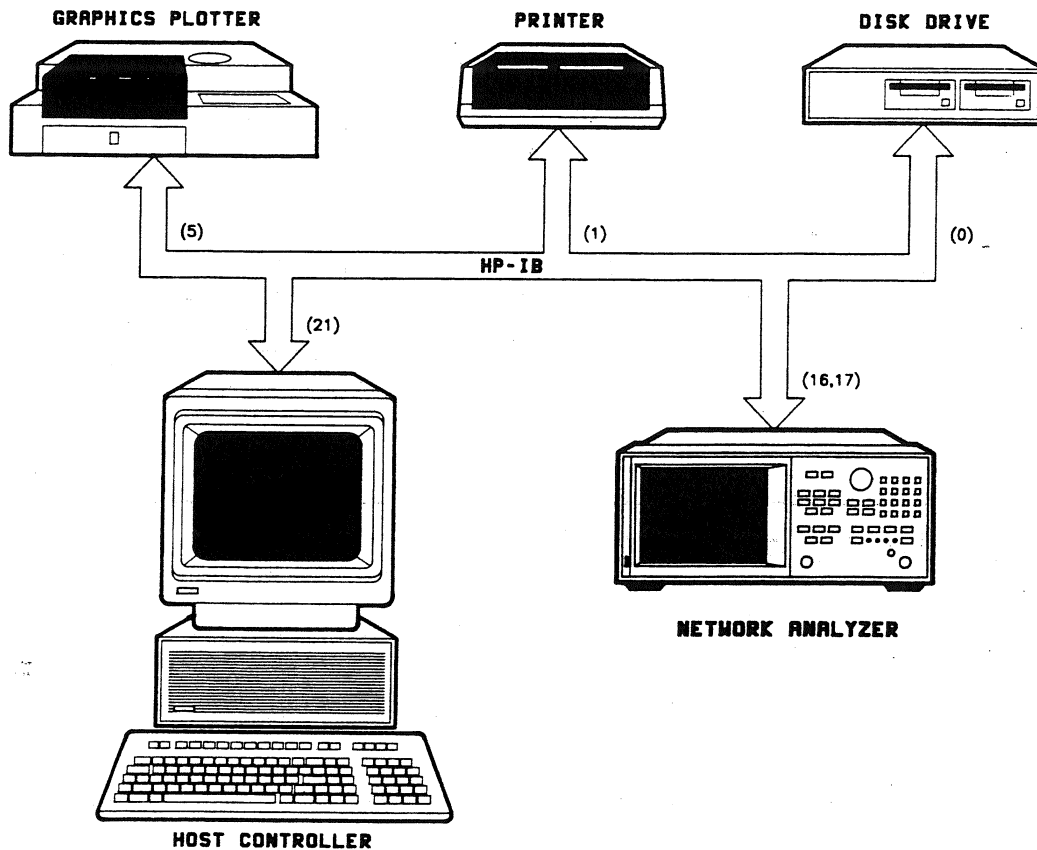

Figure 3-2. Analyzer Single Bus Concept

Three different controller modes are possible, system controller, talker/listener, and pass control.

**System Controller.** This mode allows the analyzer to control peripherals directly in a stand-alone environment (without an external controller). This mode can only be selected manually from the analyzer front panel. Use this mode for operation when no computer is connected to the analyzer. Do not use this mode for programming.

**Talker/Listener.** This is the traditional programming mode, in which the computer is involved in all peripheral access operations. Peripheral access (plotting and printing only) is also possible by addressing the analyzer to talk, addressing the peripheral to listen, and placing the HP-IB in the data mode.

**Pass Control.** This mode allows you to control the analyzer over HP-IB as with the talker/listener mode, and also allows the analyzer to take or pass control in order to plot, print, and access a disk. During the peripheral operation, the host computer is free to perform other internal tasks such as data or display manipulation (the bus is tied up by the analyzer during this time). After a task is completed, the host controller accepts control again when the analyzer returns it.

In general, use the talker/listener mode for programming the analyzer unless you desire direct peripheral access. Preset does not affect the selected bus mode, but the bus mode returns talker/listener if power is cycled.

Chapter 10 explains the three different bus modes in detail, and provides information on setting the correct bus mode. Programming information for talker/listener mode and pass control mode is provided in the *HP-IB Programming Guide*.

## SETTING ADDRESSES

In communications through HP-IB, each instrument on the bus is identified by an HP-IB address. This address code must be different for each instrument on the bus. Refer to *Address Menu* in Chapter 10 for information on default addresses, and on setting and changing addresses. These addresses are not affected when you press [PRESET] or cycle the power (although the [PRESET] key must be pressed to implement a change to the analyzer address).

## VALID CHARACTERS

The analyzer accepts ASCII letters, numbers, decimal points, +/−, semicolons, quotation marks (“”), carriage returns (CR), and linefeeds (LF). Both upper and lower case are acceptable. Leading zeros, spaces, carriage returns, and unnecessary terminators are ignored, except those within a command or appendage. Carriage returns are ignored. An invalid character causes a syntax error. Syntax errors are described in more detail under in the *HP-IB Programming Guide*.

## CODE NAMING CONVENTION

The analyzer HP-IB commands are derived from their front panel key titles (where possible), according to the naming convention below.

Convention	Key Title	For HP-IB Code Use	Example
One Word	Power Start	First Four Letters	POWE STAR
Two Words	Electrical Delay Search Right	First Three Letters of First Word First Letter of Second Word	ELED SEAR
Two Words in a Group	Marker →Center Gate →Span	First Four Letters of Both	MARKCENT GATESPAN
Three Words	Cal Kit N 50Ω Pen Num Data	First Three Letters of First Word First Letter of Second Word First Four Letters of Third Word	CALKN50 PENNDATA

Some codes require appendages (on, off, 1, 2, etc.). Codes that have no front panel equivalent are HP-IB only commands, and use a similar convention based on the common name of the function. Where possible, analyzer codes are compatible with HP 8510A/B codes.

Front panel equivalent codes and HP-IB only codes are summarized in the *HP-IB Quick Reference*.

## UNITS AND TERMINATORS

The analyzer outputs data in basic units and assumes these basic units when it receives an input, unless the input is otherwise qualified. The basic units and allowable expressions follow; either upper or lower case is acceptable.

Basic Units	Allowable Expressions
Seconds	S
Milliseconds	MS
Microseconds	US
Nanoseconds	NS
Picoseconds	PS
Femtoseconds	FS
Hertz	HZ
Kilohertz	KHZ
Megahertz	MHZ
Gigahertz	GHZ
dB or dBm	DB
Volts	V

Terminators are used to indicate the end of a command to allow the analyzer to recover to the next command in the event of a syntax error. The semicolon is the recommended command terminator. The line feed (LF) character and the HP-IB EOI line can also be used as terminators. The analyzer ignores the carriage return (CR) character.

## HP-IB DEBUG MODE

An HP-IB diagnostic feature (debug mode) is available in the HP-IB menu. Activating the debug mode causes the analyzer to scroll incoming HP-IB commands across the display. Nonprintable characters are represented with a  $\pi$ . Any time the analyzer receives a syntax error, the commands halt, and a pointer  $\wedge$  indicates the misunderstood character. The *HP-IB Programming Guide* explains how to clear a syntax error.

## DISPLAY GRAPHICS

The analyzer display can be used as a graphics display for displaying connection diagrams or custom instructions to an operator. The display accepts a subset of Hewlett-Packard Graphics Language (HP-GL) commands issued by an external computer. Some user graphics can be created using the test sequencing feature.

**NOTE:** The analyzer display occupies an additional address on the HP-IB. Determine the display bus address by adding 1 to the analyzer address (if the analyzer address is an even number), or subtracting 1 (if it is an odd number). Thus the factory default display address for graphics is 17.

As an example: type **SCRATCH**, press **[EXECUTE]**, type **EDIT**, press **[EXECUTE]**, and type in the following program:

10	OUTPUT 716;"SWET 3 S;OPC?;SING;"	Set the sweep time to 3 seconds, and OPC a single sweep.
20	DISP "SWEEPING"	
30	ENTER 716;Reply	The program will halt until the network analyzer completes the sweep and issues a one.
40	DISP "DONE"	
50	END	

Running this program causes the computer to display the sweeping message for about 3 seconds, as the instrument executes the sweep. The computer will display **DONE** just as the instrument goes into hold. When the **DONE** message appears, the program could then continue on, being assured that there is a valid data trace in the instrument. Without single sweep, we would have had to wait at least two sweep times to ensure good data.

### Preparing for HP-IB control

At the beginning of a program, the network analyzer has to be taken from an unknown state and brought under computer control. One way to do this is with an abort/clear sequence. **ABORT 7** is used to halt bus activity and return control to the computer. **CLEAR 716** will then prepare the network analyzer to receive commands by clearing syntax errors, the input command buffer, and any messages waiting to be output.

The abort/clear sequence makes the network analyzer ready to receive HP-IB commands. The next step is to put the network analyzer into a known state. The most convenient way to do this is to send **PRES**, which returns the instrument to the preset state. If preset cannot be used and the status reporting mechanism is going to be used, **CLES** can be sent to clear all of the status reporting registers and their enables.

Type **SCRATCH**, press **[EXECUTE]**, type **EDIT**, press **[EXECUTE]**, and type in the following program:

10	ABORT 7	This halts all bus action and gives active control to the computer.
20	CLEAR 716	This clears all HP-IB errors, resets the HP-IB interface, clears syntax errors. It does not affect the status reporting system.
30	OUTPUT 716;"PRES;"	Preset the instrument. This clears the status reporting system, as well as resetting all the front panel settings, except the HP-IB mode and HP-IB addresses.
40	END	

This program brings the network analyzer to a known state, ready to respond to HP-IB control.

The network analyzer will not respond to HP-IB commands unless the remote line is asserted. When the remote line is asserted and the network analyzer is addressed to listen, it automatically goes into remote mode. Remote mode means that all the front panel keys are disabled except **[LOCAL]** and the line power switch. **ABORT 7** asserts the remote line, which remains asserted until a **LOCAL 7** statement is executed. Another way to assert the remote line is to execute:

```
REMOTE 716
```

This statement asserts remote and addresses the network analyzer to listen so it goes into remote mode. Press any front panel key except local. None will respond until you press [LOCAL].

The local key can also be disabled with the sequence:

```
REMOTE 716  
LOCAL LOCKOUT 7
```

Now no front panel keys will respond. The HP 8753C can be returned to local mode temporarily with:

```
LOCAL 716
```

But as soon as the HP 8753C is next addressed to listen, it goes back into local lockout. The only way to clear local lockout, aside from cycling power, is to execute:

```
LOCAL 7
```

Which un-asserts the remote line on the interface. This puts the instrument into local mode and clears local lockout. Be sure to put the instrument back into remote mode.

## Measurement Programming

The previous section of this document outlined how to get commands into the network analyzer. The next step is to organize the commands into a measurement sequence. A typical measurement sequence consists of the following steps:

1. Set up the instrument.
2. Calibrate.
3. Connect the device.
4. Take data.
5. Post process data.
6. Transfer data.

### Set up the instrument

Define the measurement by setting all of the basic measurement parameters. These include all the stimulus parameters: sweep type, span, sweep time, number of points, and RF power level. They also include the parameter to be measured, and both IF averaging and IF bandwidth. These parameters define the way data is gathered and processed within the instrument, and to change one requires that a new sweep be taken.

There are other parameters that can be set within the instrument that do not affect data gathering directly, such as smoothing, trace scaling or trace math. These functions are classed as post processing functions: they can be changed with the instrument in hold mode, and the data will correctly reflect the current state.

The save/recall registers and the learn string are two rapid ways of setting up an entire instrument state. The learn string is a summary of the instrument state compacted into a string that can be read into the computer and retransmitted to the network analyzer. See *Example 6A, Using the learn string*, for a discussion of how to do this.

### Calibrate

Measurement calibration is normally performed once the instrument state has been defined. Measurement calibration is not required to make a measurement, but it does improve the accuracy of the data.

There are several ways to calibrate the instrument. The simplest is to stop the program and have the operator perform the calibration from the front panel. Alternatively, the computer can be used to guide the operator through the calibration, as discussed in *Example 2A and 2B, 1-port calibration and Full 2-port calibration* (HP 8753C only. Full 2-port calibration is not available in the HP 8752A). The last option is to transfer calibration data from a previous calibration back into the instrument, as discussed in *Example 6C, Reading calibration data*.

## Connect device under test

Have the operator connect and adjust the device. The computer can be used to speed the adjustment process by setting up such functions as limit testing, bandwidth searches, and trace statistics. All adjustments take place at this stage so that there is no danger of taking data from the device while it is being adjusted.

## Take data

With the device connected and adjusted, measure its frequency response, and hold the data within the instrument so that there is a valid trace to analyze.

The single sweep command `SING` is designed to ensure a valid sweep. All stimulus changes are completed before the sweep is started, and the HP-IB hold state is not released until the formatted trace is displayed. When the sweep is complete, the instrument is put into hold, freezing the data inside the instrument. Because single sweep is OPC'able, it is easy to determine when the sweep has been completed.

The number of groups command `NUMGn` is designed to work the same as single sweep, except that it triggers  $n$  sweeps. This is useful, for example, in making a measurement with an averaging factor  $n$ . ( $n$  can be 1 to 999). Both single sweep and number of groups restart averaging.

## Post process

With valid data to operate on, the post-processing functions can be used. Referring ahead to Figure 2, any function that affects the data after the error correction stage can be used. The most useful functions are trace statistics, marker searches, electrical delay offset, time domain, and gating. If a 2-port calibration is active, then any of the four S-parameters can be viewed without taking a new sweep.

## Transfer data

Lastly, read the results out of the instrument. All the data output commands are designed to ensure that the data transmitted reflects the current state of the instrument:

- `OUTPDATA`, `OUTPRAWn`, and `OUTPFORM` will not transmit data until all formatting functions have completed.
- `OUTPLIML`, `OUTPLIMM`, and `OUTPLIMF` will not transmit data until limit test has occurred, if on.
- `OUTPMARK` will activate a marker if one is not already selected, and it will make sure that any current marker searches have completed before transmitting data.
- `OUTPMSTA` makes sure that statistics have been calculated for the current trace before transmitting data. If statistics is not on, it will turn statistics on to update the current values, and then turn it off.
- `OUTPMWID` makes sure that a bandwidth search has been executed for the current trace before transmitting data. If bandwidth search is not on, it will turn the search on to update the current values, and then turn it off.

Data transfer is discussed further in Examples 3A through 3C, *Data transfer using ASCII transfer format, etc.*



# Basic Programming Examples

## Example 1: Setting up a basic measurement

In general, the procedure for setting up measurements on the network analyzer via HP-IB follows the same sequence as if the setup was performed manually. There is no required order, as long as the desired frequency range, number of points and power level are set prior to performing the calibration.

This example illustrates how a basic measurement can be set up on the network analyzer. The program will first select the desired parameter, the measurement format, and then the frequency range. Performing calibrations is described later.

By interrogating the analyzer to determine the actual values of the start and stop frequencies, the computer can keep track of the actual frequencies.

This example program is stored on the Example Programs disk as **IPG1**.

10	ABORT 7	
20	CLEAR 716	Prepare for HP-IB control.
30	OUTPUT 716;"PRES;"	Preset the network analyzer.
40	OUTPUT 716;"CHAN1; S11; LOGM;"	Make channel 1 the active channel, and measure the reflection parameter, $S_{11}$ for the HP 8753C, or REFL for the HP 8752A, displaying its magnitude in dB.
50	OUTPUT 716;"CHAN2; S11; PHAS;"	Make channel 2 the active channel, and measure the phase of $S_{11}$ on it.
60	OUTPUT 716;"DUACON;"	Tell the analyzer to display both channels simultaneously.
70	INPUT "ENTER START FREQUENCY (MHz):",F_start	Input a start frequency.
80	INPUT "ENTER STOP FREQUENCY (MHz):",F_stop	Input a stop frequency.
90	OUTPUT 716;"STAR"; F_start;"MHZ;"	Set the start frequency to F_start.
100	OUTPUT 716;"STOP";F_stop; "MHZ;"	Set the stop frequency to F_stop.
110	DISP F_start, F_Stop	Show the current start and stop frequencies.
120	END	

## Running the program

The program sets up a measurement of reflection log magnitude on channel 1, reflection phase on channel 2, and turns on the dual channel display mode. When prompted for start and stop frequencies, enter any value in MHz from 0.3 (300 kHz) to 3 GHz (1.3 GHz for the HP 8752A). These will be entered into the network analyzer, and the frequencies will be displayed.

## Performing a measurement calibration

This section will demonstrate how to coordinate a measurement calibration over HP-IB. The HP-IB program follows the keystrokes required to calibrate from the front panel: there is a command for every step.

The general key sequence is to select the calibration, measure the calibration standards, and then declare the calibration done. The actual sequence depends on the calibration kit and changes slightly for 2-port calibrations\*, which are divided into three calibration sub-sequences.

### Calibration kits

The calibration kit tells the network analyzer what standards to expect at each step of the calibration. The set of standards associated with a given calibration is termed a class. For example, measuring the short during a 1-port calibration is one calibration step. All of the shorts that can be used for this calibration step make up the class, which is called class  $S_{11}B$ . For the 7 mm\* and the 3.5 mm cal kits, class  $S_{11}B$  has only one standard in it. For type-N cal kits, class  $S_{11}B$  has two standards in it: male and female shorts.

When doing a 1-port calibration in 7\* or 3.5 mm, selecting **[SHORT]** automatically measures the short because there is only one standard in the class. When doing the same calibration in type-N, selecting **[SHORTS]** brings up a second menu, allowing the user to select which standard in the class is to be measured. The sex listed refers to the test port: if the test port is female, then the user selects the female short option.

Doing a 1-port calibration over HP-IB is very similar. In 7\* or 3.5 mm, sending CLASS11B will automatically measure the short. In type-N, sending CLASS11B brings up the menu with the male and female short options. To select a standard, use STANA or STANB. The STAN command is appended with the letters A through G, corresponding to the standards listed under softkeys 1 through 7, softkey 1 being the topmost softkey.

The STAN command is OPC'able. A command that calls a class is only OPC'able if that class has only one standard in it. If there is more than one standard in a class, the command that calls the class only brings up another menu, and there is no need to OPC it.

Hence, both the manual and HP-IB calibration sequences depend heavily on which calibration kit is active.

### Full 2-port calibrations (HP 8753C only)

Each full 2-port measurement calibration is divided into three sub-sequences: transmission, reflection, and isolation. Each subsequence is treated like a calibration in its own right: each must be opened, have all the standards measured, and then be declared done.

The opening and closing statements for the transmission sub-sequence are TRAN and TRAD. The opening and closing statements for the reflection sub-sequence are REFL and REFD. The opening and closing statements for isolation are ISOL and ISOD.

\*HP 8753 only.

## Example 2A: 1-port calibration

To demonstrate coordinating a calibration over HP-IB, the following program does a 1-port calibration, using the HP 85032B 50 ohm type-N calibration kit. This program simplifies the calibration for the operator by giving explicit directions on the network analyzer display, and allowing the user to continue the program from the network analyzer front panel.

This example program is stored on the Example Programs disk as **IPG2A**.

10	ABORT 7	
20	CLEAR 716	Prepare for HP-IB control.
30	OUTPUT 716;"CALKN50; MENUOFF;CLES;ESE 64;"	This is the minimum instrument set up: the 50 ohm type-N cal kit is selected, the softkey menu is turned off, and the status reporting system is set up so that bit 6, User Request, of the event status register, is summarized by bit 5 of the status byte. This allows us to detect a key press with a serial poll. Refer to Appendix A.
40	OUTPUT 716;"CALIS111;"	Open the calibration by calling the S <sub>11</sub> 1-port calibration.
50	CALL Waitforkey("CONNECT LOAD AT PORT 1")	Now ask for the load, and wait for the operator. The Waitforkey subroutine will not return until the operator presses a key on the front panel of the network analyzer.
60	OUTPUT 716;"OPC?; CLASS11C;"	There is only one choice in this class, so the CLASS command is OPC'able. Using the OPC? command causes the program to wait until the standard has been measured before continuing. This is very important, because the prompt to connect the next standard should only appear after the first standard is measured.
70	ENTER 716;Reply	Wait until the network analyzer is done with the standard.
80	CALL Waitforkey("CONNECT OPEN AT PORT 1")	Ask for an open, and wait for the operator to connect it.
90	OUTPUT 716;"CLASS11A; OPC?; STANB;"	Measure the open. There is more than one standard in this loads class, so we must identify the specific standard within that class. The female open is the second softkey selection from the top in the menu, so select a lowband load as the standard using the command STANB.
100	ENTER 716;Reply	Wait for the standard to be measured.
110	CALL Waitforkey("CONNECT SHORT LOAD AT PORT 1")	Have the operator connect the short and wait for a reply.
120	OUTPUT 716;"CLASS11B; OPC?; STANB;"	There is more than one standard in the short class, too. The specific standard is the female short, or STAN B. Measure the short.
130	ENTER 716;Reply	Wait for the standard to be measured.
140	OUTPUT 717;"PG;"	The PG command sent to the display clears the user graphics, removing the last prompt.

150	DISP "COMPUTING CALIBRATION COEFFICIENTS"	
160	OUTPUT 716;"DONE;OPC?; SAV1;"	Affirm the completion of the calibration, and save the calibration.
170	ENTER 716;Reply	Wait until the network analyzer is done calculating the calibration coefficients before allowing the program to go on.
180	DISP "1-PORT CAL COMPLETED. CONNECT TEST DEVICE."	
190	OUTPUT 716;"MENUON;"	The calibration is complete, so turn the softkey menu back on.
200	END	
210	SUB Waitforkey(Lab\$)	This subroutine displays the passed message on the network analyzer, and waits for the operator to press a key. It assumes that bit 6, User Request, of the event status register has been enabled.
220	DISP Lab\$	First, display a message on the computer in case the operator has returned to the computer keyboard.
230	OUTPUT 717;"PG;PU;PA390, 3600; PD;LB";Lab\$;", PRESS ANY KEY WHEN READY;"	This statement writes on the network ana- lyzer's display. PG (page) clears old user graphics. PU (pen up) prevents anything from being drawn. PA390,3600; moves the logical pen to just above the message area on the display. PD (pen down) enables drawing. LB (label) writes the message on the display. The label command is termi- nated with an ETX symbol, which is [CTRL] [C] (pressed simultaneously) on the keyboard.
240	CLEAR 716	Clear the message line on the network analyzer.
250	OUTPUT 716;"ESR?;"	Clear the latched User Request bit so that old key presses will not trigger a measurement.
260	ENTER 716;Estat	
270	Stat=SPOLL(716)	Now wait for a key press to be reported.
280	IF NOT BIT(Stat,5) THEN GOTO 340	
290	SUBEND	

## Running the program

The program assumes that the port being calibrated is a 50 ohm, type-N female test port. The prompts appear just above the message line on the network analyzer display. Pressing any key on the front panel of the network analyzer continues the program and measures the standard. The program will display a message when the measurement calibration is complete.

Before running the program, set up the desired instrument state. This program does not modify the instrument state in any way. Run the program, and connect the standards as prompted. When the standard is connected, press any key on the network analyzer's front panel to measure it.

## Example 2B: Full 2-port measurement calibration (HP 8753C only)

This example shows how to perform a full 2-port measurement calibration using the HP 85032B calibration kit. The main difference between this example and Example 2A is that in this case, the calibration process allows removal of both the forward and reverse error terms, so that all four S-parameters of the device under test can be measured. Port 1 is a female test port and Port 2 is a male test port. This example program is stored on the Example Programs disk as **IPG2B**.

10	ABORT 7	
20	CLEAR 716	
30	OUTPUT 716;"CALKN50; MENUOFF;CLES;ESE 64;"	This is the minimum instrument set up: the 50 ohm type-N kit is selected, the softkey menu is turned off, and the status reporting system is set up so that bit 6, User Request, of the event status register, is summarized by bit 5 of the status byte. This allows us to detect a key press with a serial poll. Refer to Appendix A.
40	OUTPUT 716;"CALIFUL2;"	Open the calibration by calling for a full 2-port calibration.
50	OUTPUT 716;"REFL;"	Open the reflection calibration subsequence.
60	CALL Waitforkey("CONNECT OPEN AT PORT 1")	Ask for the open, and wait for the operator. The Waitforkey subroutine will not return until a key on the front panel of the HP 8753C is pressed.
70	OUTPUT 716;"CLASS11A; OPC?;STANB;"	There is more than one standard in the open class, so we must identify the specific standard within that class. The female open selection is the second softkey from the top in the menu, so we select a broadband load as the standard using the command STANB.
80	ENTER 716;Reply	Wait until the HP 8753C is done with the standard.
90	CALL Waitforkey("CONNECT SHORT AT PORT 1")	Ask for a short, and wait for the operator to connect it.
100	OUTPUT 716;"CLASS11B; OPC?;STANB;"	Measure the short.
110	ENTER 716;Reply	Wait for the standard to be measured.
120	CALL Waitforkey("CONNECT BROADBAND LOAD AT PORT 1")	Have the operator connect the broadband load, and wait for his reply.
130	OUTPUT 716;"OPC?; CLASS11C;"	There is only one choice in this class, so the CLASS command is OPC'able. Using the OPC? command causes the program to wait until the standard has been measured before continuing. This is important, because the prompt to connect the next standard should appear only after the first standard is measured.
140	ENTER 716;Reply	Wait for the standard to be measured.
150	CALL Waitforkey("CONNECT OPEN AT PORT 2")	Ask for the male open for port 2, and wait for the operator.

160	OUTPUT 716;"CLASS22A; OPC?;STANA;"	Measure the open.
170	ENTER 716;	Reply Wait until the HP 8753C is done with the standard.
180	CALL Waitforkey("CONNECT SHORT AT PORT 2")	Ask for a male short, and wait for the operator to connect it.
190	OUTPUT 716;"CLASS22B; OPC?;STANA;"	Measure the short.
200	ENTER 716;Reply	Wait for the standard to be measured.
210	CALL Waitforkey("CONNECT LOAD AT PORT 2")	Have the operator connect the load, and wait for a reply.
220	OUTPUT 716;"OPC?; CLASS22C;"	Measure the load.
230	ENTER 716;Reply	Wait for the standard to be measured.
240	OUTPUT 716;"REFD;"	Close the reflection calibration subsequence.
250	DISP "COMPUTING REFLECTION CALIBRATION COEFFICIENTS"	
260	OUTPUT 716;"TRAN;"	Open the transmission calibration subsequence.
270	CALL Waitforkey("CONNECT THRU (PORT 1 TO PORT 2)")	
280	DISP "MEASURING FORWARD TRANSMISSION")	
290	OUTPUT 716;"OPC?;FWDT;"	Measure forward transmission.
300	ENTER 716;Reply	
310	OUTPUT 716;"OPC?;FWDM;"	Measure forward load match.
320	ENTER 716;Reply	
330	DISP "MEASURING REVERSE TRANSMISSION")	
340	OUTPUT 716;"OPC?;REVT;"	Measure reverse transmission.
350	ENTER 716;Reply	
360	OUTPUT 716;"OPC?;REVM;"	Measure reverse load match.
370	ENTER 716;Reply	
380	OUTPUT 716;"TRAD;"	Close the transmission calibration sub-sequence.
390	INPUT "SKIP ISOLATION CAL? Y OR N.", An\$	Ask operator if the isolation cal should be skipped.
400	"IF An\$="Y" THEN	If the answer is yes, skip the isolation cal and branch to the computation of the calibration coefficients.
410	OUTPUT 716;"OMII;"	
420	GOTO 520	
430	END IF	
440	CALL Waitforkey("ISOLATE TEST PORTS")	Ask operator to isolate the test ports.

450	OUTPUT 716;"ISOL;" AVERFACT10;AVEROON;"	Open the isolation calibration subsequence. Turn on averaging with an averaging factor of 10 for the isolation cal.
460	DISP "MEASURING REVERSE ISOLATION"	
470	OUTPUT 716;"OPC?;REVI;"	Measure reverse isolation.
480	ENTER 716;Reply	
490	DISP "MEASURING FORWARD ISOLATION"	
500	OUTPUT 716;"OPC?;FWDI;"	Measure forward isolation.
510	ENTER 716;Reply	
520	OUTPUT 716;"ISOD; AVEROOFF;"	Close the isolation calibration subsequence and turn off averaging.
530	OUTPUT 717;"PG;"	The PG command sent to the display clears the user graphics, removing the last prompt.
540	DISP "COMPUTING CALIBRATION COEFFICIENTS"	
550	OUTPUT 716;"OPC?;SAV2;"	
560	ENTER 716;Reply	Wait until the HP 8753C is done calculating the calibration coefficients before going on.
570	DISP "DONE FULL 2-PORT CAL. CONNECT TEST DEVICE. "	
580	OUTPUT 716;"MENUON;"	The calibration is completed, so turn the soft key menu back on.
590	END	
600	SUB Waitforkey(Lab\$)	This subroutine displays the passed message on the HP 8753C, and waits for the opera- tor to press a key. It assumes that bit 6, User Request, of the event status register has been enabled.
610	DISP Lab\$	First, display a message on the computer in case the operator has returned to the computer keyboard.
620	OUTPUT 717;"PG;PU;PA390, 3600;PD;LB";Lab\$;", PRESS ANY KEY*;"	This statement writes on the HP 8753C's display. PG (page) clears old user graphics. PU (pen up) prevents anything from being drawn. PA390, 3600; moves the logical pen to just above the message area on the display. PD (pen down) enables drawing. LB (label) writes the message on the display. The label command is terminated with an ETX symbol, which is [CTRL] [C] on the keyboard.
630	CLEAR 716	Clear the message line on the HP 8753C.
640	OUTPUT 716;"ESR?;"	Clear the latched User Request bit so that old key presses will not trigger a measurement.
650	ENTER 716;Estat	Now wait for a key press to be reported.
660	Stat\$zeSPOLL(716)	

```

670   IF NOT BIT(Stat,5) THEN
      GOTO 660
680   OUTPUT 717;"PG;"          Clear the prompt from the display.
690   SUBEND

```

## Running the program

The program assumes that the test ports being calibrated are type-N, port 1 being a female test port and port 2 being a male test port. The HP 85032B 50 ohm type-N calibration kit is to be used. The prompts appear just above the message line on the HP 8753C display. Pressing any key on the front panel of the HP 8753C continues the program and measures the standard. The operator has the option of omitting the isolation cal. If the isolation cal is performed, averaging is automatically employed to ensure a good calibration. The program will display a message when the measurement calibration is complete.

Before running the program, set up the desired instrument state. This program does not modify the instrument state in any way. Run the program, and connect the standards as prompted. When the standard is connected, press any key on the HP 8753C's front panel to measure it.

## Data transfer from analyzer to computer

### Using markers to obtain trace data at specific points

Trace information can be read out of the network analyzer in several ways. Data can be read off the trace selectively using the markers, or the entire trace can be read out. If only specific information such as a single point off the trace or the result of a marker search is needed, the marker output command can be used to read the information. If all the trace data is needed, see Examples 3A thru 3C.

To get data off the trace using the marker, the marker first has to be put at the frequency desired. This is done with the marker commands. For example, execute:

```
OUTPUT 716;"MARK1 1.20 GHZ;"
```

This places marker one at 1.20 GHz. If the markers are in continuous mode, the marker value will be linearly interpolated from the two nearest points if 1.2000 GHz was not sampled. This interpolation can be prevented by putting the markers into discrete mode. The key sequence for this is [LOCAL] [MKR] [MARKER MODE MENU] [MARKERS:DIS-CRETE]. To do it over HP-IB, execute:

```
OUTPUT 716;"MARKDISC;"
```

After executing this, note that the marker is may no longer be precisely on 1.20 GHz. (This depends on the start and stop frequencies).

Another way of using the markers is to let the network analyzer pick the stimulus value on the basis of one of the marker searches: max, min, target value, or bandwidths search. For example, execute:

```
OUTPUT 716;"SEAMAX;"
```

This executes a one-time trace search for the trace maximum, and puts the marker at that maximum. In order to continually update the search, turn tracking on. The key sequence is [MKR FCTN] [MKR SEARCH] [TRACKING] [SEARCH: MAX]. To do it over HP-IB, execute:

```
OUTPUT 716;"TRACKON;SEAMAX;"
```

The trace maximum search will stay on this time, until search is turned off, tracking is turned off, or all markers are turned off. For example, execute:

```
OUTPUT 716;"MARKOFF;"
```



Marker data is read out with the command OUTPMARK. This command causes the network analyzer to transmit three numbers: marker value 1, marker value 2, and marker stimulus value. In this case we get the log magnitude at marker 1, zero, and the marker frequency. See Table 1 for all the different possibilities for values one and two. The third value is frequency in this case, but it could have been time as in time domain (option 010 only) or CW time.

Type **SCRATCH**, press **[EXECUTE]**, type **EDIT**, press **[EXECUTE]**, and then type in the following program:

10	OUTPUT 716;"SEAMIN; OUTPMARK;"	Have the network analyzer search out the trace minimum, and then output the marker values at that point.
20	ENTER 716;Val1,Val2,Stim	Read marker value 1, marker value 2, and the stimulus value.
30	DISP Val1,Val2,Stim	Display the values.
40	END	

Run the program. The values displayed by the computer should agree with the marker values displayed on the network analyzer, except that the second value displayed by the computer will be meaningless in phase and log mag formats. To see the possibilities for different values, run the program three times: once in log magnitude format, once in phase format, and once in Smith chart format. To change display format, press **[LOCAL] [FORMAT]** and then select the desired format.

## Trace transfer

Getting trace data out of the network analyzer with a 200/300 series computer can be broken down into three steps:

1. Setting up the receive array.
2. Telling the network analyzer to transmit the data.
3. Accepting the transferred data.

Data inside the network analyzer is always stored in pairs, to accommodate real/imaginary pairs, for each data point. Hence, the receiving array has to be two elements wide, and as deep as the number of points. This memory space for this array must be declared before any data is to be transferred from the network analyzer to the computer.

The network analyzer can transmit data over HP-IB in five different formats. The type of format affects what kind of data array is declared (real or integer), since the format determines what type of data is transferred. Examples for data transfers using different formats are given below. The first, Example 3A, illustrates the basic transfer using form 4, an ASCII transfer. For more information on the various data formats, see the section entitled *Data Formats*. For information on the various types of data that can be obtained (raw data, corrected data and so on), see the section entitled *Data Levels*.

Note that Example 9, *Reading disk files into a computer*, allows the operator to access disk files from a computer.

Table 1. Units as a Function of Display Format

DISPLAY FORMAT	MARKER MODE	OUTPMARK value1, value2	OUTPFORM value1, value2	MARKET READOUT value, aux value**
LOG MAG		dB,*	dB,*	dB,*
PHASE		degrees,*	degrees,	degrees,*
DELAY		seconds,*	seconds,*	seconds,*
SMITH CHART	LIN MKR	lin mag, degrees	real, imag	lin mag, degrees
	LOG MKR	dB, degrees	"	dB, degrees
	Re/Im	real, imag	"	real, imag
	R + jX	real, imag ohms	"	real, imag ohms
	G + jB	real, imag Siemens	"	real, imag Siemens
POLAR	LIN MKR	lin mag, degrees	real, imag	lin mag, degrees
	LOG MKR	dB, degrees	"	dB, degrees
	Re/Im	real, imag	"	real, imag
LIN MAG		lin mag,*	lin mag,*	lin mag,*
REAL		real,*	real,*	real,*
SWR		SWR,*	SWR,*	SWR,*
* Value not significant in this format, but is included in data transfers.				
** The marker readout values are the marker values displayed in the upper left hand corner of the display. They also correspond to the value and aux value associated with the fixed marker.				

### Example 3A: Data transfer using form 4 (ASCII transfer)

As detailed in the HP-IB Quick Reference, when form 4 is used, each number is sent as a 24 character string, each character being a digit, sign, or decimal point. Since there are two numbers per point, a 201 point transfer in form 4 takes 9,648 bytes. An example simple data transfer using form 4, an ASCII data transfer is shown in this program.

This example program is stored on the Example Programs disk as **IPG3A**.

10	ABORT 7	
20	CLEAR 716	Prepare for HP-IB control.
30	OUTPUT 716;"PRES;"	Preset the analyzer.
40	DIM Dat(1:11,1:2)	This line sets up an array to receive the data. The ENTER 716;Dat(*) statement in line 60 fills the array Dat automatically, changing the second subscript fastest. Since the network analyzer transmits the data as ordered pairs, we make the second dimension two so that the pairs will be properly grouped. The number of points will be set to 11, so we know to make the first dimension 11.
50	OUTPUT 716;"POIN 11; SING; FORM4;OUTPFORM;"	Set the number of points, tell the network analyzer to use ASCII transfer format, and request the formatted trace data. Frequency information is not included in the transfer.
60	ENTER 716;Dat(*)	The computer takes the data from the instrument and puts it in the receiving array. By specifying Dat(*), we have told the enter statement to fill every location in the array.
70	DISP DAT(1,1),DAT(1,2)	This line checks the first data point received. The data is in the current network analyzer display format: see Table 1 for the contents of the array as a function of display format.
80	END	

### Running the program

The first number of the result is a trace value in dB, and the second is zero. Put a marker at 300 kHz, which was the first point transmitted, to see that the values displayed by the computer agree with the network analyzer. No matter how many digits are displayed, the network analyzer is specified to measure magnitude to a resolution of .001 dB, phase to a resolution of .01 degrees, and group delay to a resolution of .01 psec.

Changing the display format will change the data sent with the OUTPFORM transfer. See Table 1 for a list of what data is provided with what formats. The data from OUTPFORM reflects all the post processing such as time domain, gating, electrical delay, trace math, and smoothing. If time domain (option 010 only) is on, operation is limited to 201 points in the lowpass mode.

Relating the data from a linear frequency sweep to frequency can be done by interrogating the start frequency, the frequency span, and the number of points. The frequency of point N in a linear frequency sweep is just:

$$F = \text{Start\_frequency} + (N-1) \times \text{Span}/(\text{Points}-1)$$

It is possible to read the frequencies directly out of the instrument with the OUTPLIML command. OUTPLIML reports the limit test results by transmitting the stimulus point tested, a number indicating the limit test results, and the upper and lower limits at that stimulus point, if available. The number indicating the limit results is a -1 for no test, 0 for fail, and 1 for pass. If there are no limits available, the network analyzer transmits zeros.

For this example, throw away the limit test information and keep the stimulus information. Edit line 40 to read:

```
40 DIM Dat(1:11,1:2), Stim(1:11)
```

And type in:

```
70 OUTPUT 716;"OUTPLIML;"           Request the limit test results.
80 FOR I=1 TO 11                     Loop 11 times to read in all 11 data points.
90 ENTER 716;Stim(I),                Read the stimulus values in, throw the rest
   Reslt,Uprr,Lwr                    away. Because we are not loading the data
                                       into a single array, it is necessary to loop
                                       and read every point.
100 PRINT Stim(I),Dat(I,1),           Print the data value and stimulus value.
    Dat(I,2)
110 NEXT I
120 DISP Reslt,Uprr,Lwr              Show what the last limit test result was, just
                                       to see what came out.
130 END
```

Running this program will print out all the trace data and the stimulus values. Put the instrument into a log frequency sweep by pressing [LOCAL] [MENU] [SWEEP TYPE MENU] [LOG FREQ], and run the program again. If you define a list frequency table with 11 points, this program will still show the sampled frequencies. If you define a limit test table, Reslt will hold the limit test results.

## Data levels

Different levels of data can be read out of the instrument (see Figure 2). There is available:

- Raw data. The basic measurement data, reflecting the stimulus parameters, IF averaging, and IF bandwidth. If a full 2-port measurement calibration is on, there are four raw arrays kept: one for each raw S-parameter. The data is read out with the commands OUTPRAW1, OUTPRAW2, OUTPRAW3, OUTPRAW4. Normally, only raw 1 is available, and it holds the current parameter. If a 2-port calibration is on, the four arrays refer to S<sub>11</sub>, S<sub>21</sub>, S<sub>12</sub>, and S<sub>22</sub> respectively. This data is in real/imaginary pairs.
- Error Corrected data. This is the raw data with error correction applied. The array is for the currently measured parameter, and is in real/imaginary pairs. The error corrected data is read out with OUTPDATA. OUTPMEMO reads the trace memory if available, which is also error corrected. Neither raw nor error corrected data reflect such post-processing functions as electrical delay offset, trace math, or time domain gating.
- Formatted data. This is the array of data being displayed. It reflects all post-processing functions such as electrical delay or time domain, and the units of the array read out depends on the current display format. See Table 1 for the various units as a function of display format.
- Calibration coefficients. The results of a calibration are arrays of calibration coefficients which are used in the error correction routines. Each array corresponds to a specific error term in the error model. The HP-IB Quick Reference details which error coefficients are used for specific calibration types, and which arrays those coefficients are to be found in. Not all calibration types use all 12 arrays. The data is stored as real/imaginary pairs.

Formatted data is generally the most useful, being the same information seen on the display. However, if the post processing is not necessary, as may be the case with smoothing, error corrected data is more desirable. Error corrected data also gives you the opportunity to put the data into the instrument and apply post-processing at a later time.

As an example of error corrected data, change line 50 to:

```
50 OUTPUT 716;"POIN 11; SING; FORM4; OUTPDATA;"
```

Running the program now displays real and imaginary trace data, regardless of what display format is currently being used. Select the real display format to verify that the data is the real portion.

## Data formats

The network analyzer can transmit data over HP-IB in four different formats. Until now, we have been using form 4, an ASCII data transfer. Another option is to use form 3, which is the IEEE 64 bit floating point format. In this mode, each number takes only 8 bytes instead of 24. This means that a 201 point transfer takes only 3,216 bytes. Data is stored internally in the 200/300 series computer with the IEEE 64 bit floating point format, eliminating the need for any reformatting by the computer.

## MS-DOS® personal computer format

Use form 5 to transfer data to an MS-DOS® PC. This mode is a modification of IEEE 32 bit floating point format with the byte order reversed. Form 5 also has a four byte header which must be read in so that data order is maintained. In this mode, an MS-DOS® PC can store data internally without reformatting it.

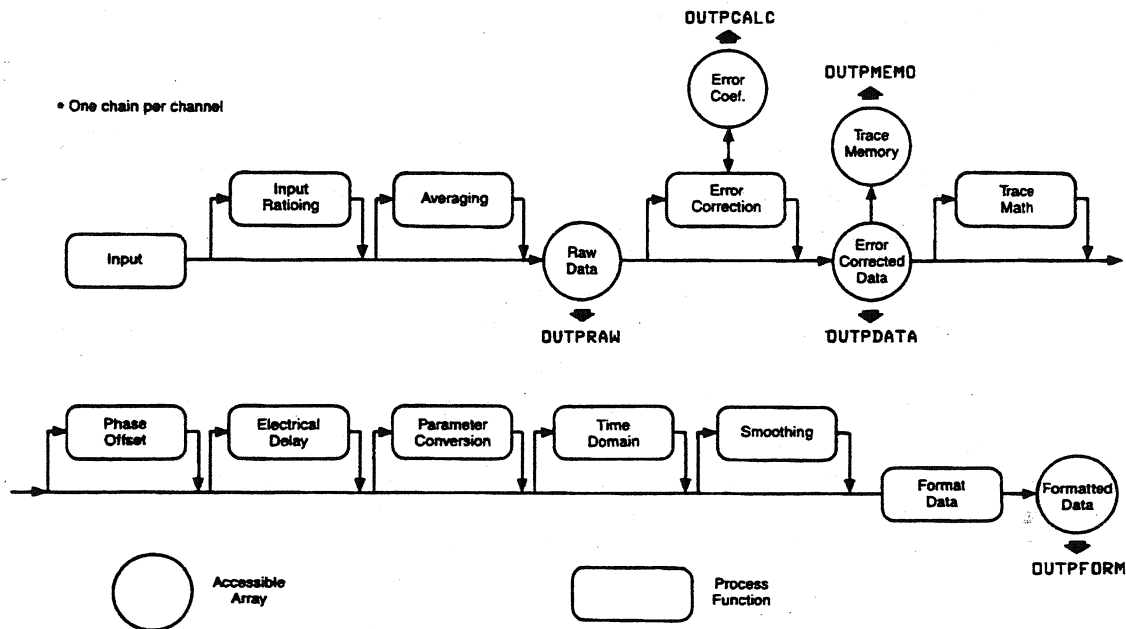

Figure 2. Data processing chain

## Example 3B: Data transfer using form 3 (IEEE 64 bit floating point format)

This program illustrates data transfer using form 3, in which data is transmitted in the IEEE 64 bit floating point format.

To use form 3, the computer is told to stop formatting the incoming data with the ENTER statement. This is done by defining an I/O path with formatting off. Form 3 also has a four byte header to deal with. The first two bytes are the ASCII characters "#A" that indicate that a fixed length block transfer follows, and the next two bytes form an integer containing number of bytes in the block to follow. The header must read in so that data order is maintained.

This example program is stored on the Example Programs disk as **IPG3B**.

10	ABORT 7	
20	CLEAR 716	Prepare for HP-IB control.
30	DIM Dat(1:201,1:2)	As before, prepare the receiving array.
40	INTEGER Hdr,Lgth	Since an integer takes two bytes, Hdr and Lgth will take care of the four byte header. Lgth will hold the number of bytes in the data block.
50	ASSIGN @Dt TO 716;FORMAT OFF	This statement defines a data I/O path with ASCII formatting off. The I/O path points to the network analyzer, and can be used to read or write data to the instrument, as long as that data is in binary rather than ASCII format.
60	OUTPUT 716;"SING; FORM3;OUTPFORM;"	The analyzer is told to output formatted data using form 3.
70	ENTER @Dt;Hdr,Lgth,Dat(*)	The data is read in much as before, but the I/O path has format off to accept the binary data from form 3. The network analyzer and the computer must be in agreement as to the format of the data being transmitted.
80	DISP Lgth,Dat(1,1),Dat(1,2)	
90	END	

### Running the program

Preset the instrument and run the program. The computer displays 3,216 and the trace values at 300 kHz. The number 3,216 comes from 201 points, 2 values per point, 8 bytes per value. This transfer is more than twice as fast as a form 4 transfer.

To illustrate a point, go to the instrument and press **[LOCAL] [MENU] [NUMBER of POINTS]**, and key in **101 [x1]**. Now run the program again: a BASIC error will be generated because the network analyzer ran out of data to transmit before the variable list was full.

Go to the instrument again, and this time change the number of points to 401. Running the program again does not generate an error, but not all of the data was read in. The network analyzer is still waiting to transmit data, but the program has not been designed to detect the situation.

As illustrated above, it is imperative that the receiving array be correctly dimensioned. There are two things that assure correct dimensions. First, the number of points is readily available through **POIN?** or through the header that precedes forms 1, 2 and 3. Second, BASIC allows dimensioning, redimensioning, allocating, and deallocating statements anywhere in a program. We can take advantage of this in simple programs to wait until we know how many points to expect before we dimension.

BASIC offers two options to those who want to dimension an array with a variable expression, such as the number of points in the sweep. One is the REDIM statement, available with AP2 1 or the MAT binary, which redimensions a given array to any size less than or equal to its originally dimensioned size. The other option is to ALLOCATE the array just before using it, and DEALLOCATE when it's no longer needed. ALLOCATE works exactly like DIM, except that when you deallocate, the memory space is returned to general use and you can re-use the variable name. All of the following examples use ALLOCATE.

For example, delete line 30 and type in the following lines over the last program:

```
70     ENTER @Dt;Hdr,Lgth
80     ALLOCATE Dat(1:Lgth/16,1:2)      This guarantees that the receiving array is
                                         the correct size. In form 3, each number is 8
                                         bytes, and there are two numbers per point,
                                         so we divide Lgth by 16 to get number of
                                         points.
90     ENTER @Dt;Dat(*)
100    DISP Dat(Lgth/16,1)             Display the last number read in.
110    END
```

Set the number of points to 51 and run the program: this time no errors are generated. Set the number of points to 401, and run the program again. Move a marker to the last point on the trace, and check to see that the last point read in was the last point on the trace, as expected.

There are two other formats available. Form 2 is not used with 200/300 computers, and form 1 is a special high speed transfer. Form 1 is a condensed transfer format that is useful if data is being transferred out of the network analyzer for direct storage and later re-transmission to the network analyzer. Example 3C gives an example of a data transfer using form 1.

### Example 3C: Data transfer using form 1 (network analyzer internal format)

In form 1, each data point is sent out as it is stored inside the network analyzer, in a six byte binary string. It is a very fast transfer, using only 1206 bytes to transfer 201 points, but it is difficult to decode. (Real/imaginary data uses the first two bytes for the imaginary fraction mantissa, the middle two bytes for the real fraction mantissa, the fifth byte is used for additional resolution when transferring raw data, and the last byte as the common power of two). The data could be recombined and displayed in the computer, but this requires reformatting time.

In this example, we use form 1 to get data to store on disk. Before running this program, be sure that the mass storage device is a disk drive with a formatted disk in it. We also introduce a method of loading data back into the network analyzer. For most OUTPxxxx commands, there is a corresponding INPUxxxx command, and here we take advantage of that to load error corrected data back into the instrument.

This example program is stored on the Example Programs disk as **IPG3C**.

10	ABORT 7	
20	CLEAR 716	Prepare for HP-IB control.
30	INTEGER Hdr,Lgth	Set up to integers to take the header, the same as with form 3.
40	ASSIGN @Dt TO 716;FORMAT OFF	
50	OUTPUT 716;"SING;FORM1;OUTPDATA;"	Have the network analyzer take a sweep, and prepare to transmit the trace data to the computer.
60	ENTER @Dt;Hdr,Lgth	
70	CREATE BDAT "TESTDATA",1,Lgth+4	This statement creates a disk file to store the form 1 data in. It creates a binary data file name TESTDATA. The file is 1 record long, using a record length of Lgth + 4 bytes. The extra 4 bytes are for the header. This example will not run unless MASS STORAGE IS points to a disk drive with a formatted disk it, and that disk cannot have a file named TESTDATA on it.
80	ASSIGN @Disc TO "TESTDATA"	This statement creates a data I/O path pointing to the file TESTDATA.
90	ALLOCATE INTEGER Dat (1:Lgth/6,1:3)	Create an integer receiving array. There are six bytes per point in form 1, so allocating 3 integers per point will hold the data correctly, since an integer is two bytes.
100	ENTER @Dt;Dat(*)	The data is received much as before.
110	OUTPUT @Disc;Hdr,Lgth, Dat(*)	Write the data to the disk drive.
120	INPUT "CHANGE TRACE AND HIT RETURN",Dum\$	Disconnect the test device, and take a sweep. Read the data off the disk, and put it back in the instrument.
130	OUTPUT 716;"SING;"	Take one sweep and hold.
140	ASSIGN @Disc TO "TESTDATA"	Re-establish the data path. This is necessary to begin reading data from the start of the file, rather than the end of the file where the file pointer was left by line 110.



```
150  ENTER @Disc;Hdr,Lgth, Dat(*)  Get the information.
160  OUTPUT 716;"INPUDATA"
170  OUTPUT @Dt;Hdr,Lgth,Dat(*)    And copy it out to the network analyzer.
180  ASSIGN @Disc TO *             Close the file.
190  DEALLOCATE Dat(*)            Release the memory for the data array.
200  PURGE "TESTDATA"            And purge the data file.
210  END
```

### Running the program

A data file is stored to disk during program execution. Either remove the write-protection from the Example Programs disk or install a blank, formatted data disk. Preset the network analyzer, and run the program. When the program pauses press [LOCAL], change the trace, and press [RETURN]. When the data is reloaded into the network analyzer, it will be formatted and displayed as the current trace. This form of data transfer is faster than the transfer using form 3.

# Advanced Programming Examples

## Using list frequency mode

The network analyzer takes data points spaced at regular intervals across the overall frequency range of the measurement. For a 2 GHz frequency span using 201 points, data will be taken at intervals of 10 MHz. The list frequency mode lets you select the specific points or frequency spacing between points at which measurements are to be made. This allows flexibility in setting up tests to ensure efficient device performance. Sampling specific points reduces measurement time since additional time is not spent measuring device performance at frequencies not needed.

The following examples illustrate the use of the network analyzer's list frequency mode to perform arbitrary frequency testing. Example 4A lets you construct a table of list frequency segments which is then loaded into the network analyzer's list frequency table. Each segment stipulates a start and stop frequency, and the number of data points to be taken over that frequency range. Example 4B lets you select a specific segment to "zoom-in" on. A single instrument can be ready to measure several different devices, each with its own frequency range, using a single calibration performed with all of the segments active. When a specific device is connected, you select the appropriate segment for that device. The list frequency segments can be overlapped, but the number of points in all the segments must not exceed 1632 points.

### Example 4A: Setting up a list frequency sweep

This example shows how to create a list frequency table and transmit it to the network analyzer.

The command sequence for entering a list frequency table imitates the key sequence followed when entering a table from the front panel: there is a command for every key press. Editing a segment is also the same as the key sequence, but the network analyzer automatically reorders each edited segment in order of increasing start frequency.

The list frequency table is also carried as part of the learn string. While it cannot be modified as part of the learn string, it can easily be stored and recalled.

This example takes advantage of the computer's capabilities to simplify creating, adding to, and editing the table. The table is entered and completely edited before being transmitted to the network analyzer. To simplify the programming task, options such as entering center/span or step size are not included. For information on reading list frequency data out of the network analyzer, see the section *Data transfer from analyzer to computer*.

This program is stored on the Example Programs disk as **IPG4A**.

10	ABORT 7	
20	CLEAR 716	Prepare the network analyzer for HP-IB control.
30	OUTPUT 716;"EDITLIST;"	Activate the frequency list edit mode.
40	OUTPUT 716;"CLEL;"	Delete any existing segments.
50	INPUT "Number of segments?", Numb	Find out how many segments to expect.
60	ALLOCATE Table(1:Numb,1:3)	Create a table to hold the segments. Keep start frequency, stop frequency, and number of points.
70	PRINTER IS 1	Make sure we print on the screen.
80	OUTPUT 2;CHR\$(255)&"K";	Clear the screen.

90	PRINT USING "10A,10A,10A,20A"; "SEGMENT", "START(MHZ)", "STOP(MHZ)", "NUMBER OF POINTS"	Print the table header.
100	FOR I=1 TO Numb	Read in each segment.
110	GOSUB Loadpoin	(line 300) reads in the start frequency, stop frequency, and number of points for segment I. Since Loadpoin is a subroutine, I is used as a global variable.
120	NEXT I	
130	LOOP	Use the LOOP, EXIT IF, END LOOP structure to loop and edit the table until editing is no longer needed. This structure sets up a loop with the exit point in the middle of the loop rather than at the beginning (as with WHILE, END WHILE), or at the end (as with REPEAT, UNTIL).
140	INPUT "DO YOU WANT TO EDIT? Y OR N",An\$	Edit the table. Editing is re-entering the entire segment. The old segment values are left in place if return is pressed without typing anything.
150	EXIT IF An\$="N"	Exit the edit loop if editing is finished. Execution is continued at line 210.
160	INPUT "ENTRY NUMBER?",I	For editing, get the entry number.
170	GOSUB Loadpoin	Re-enter the values.
180	END LOOP	
190	OUTPUT 716;"EDITLIST"	To begin the table, open the list frequency table for editing. The table must be empty, or these segments will be added on top of the old ones.
200	FOR I=1 TO Numb	Loop for each segment.
210	OUTPUT 716;"SADD;STAR"; Table(I,1);"MHZ;"	
220	OUTPUT 716;"STOP"; Table(I,2);"MHZ;"	
230	OUTPUT 716;"POIN", Table(I,3),";"	Enter the segment values.
240	OUTPUT 716;"SDON;"	Declare the segment done.
250	NEXT I	
260	OUTPUT 716;"EDITDONE; LISFREQ;"	Close the table, and turn on list frequency mode.
270	STOP	
280	Loadpoin: !	Enter in a segment.
290	INPUT "START FREQUENCY? (MHZ)",Table(I,1)	
300	INPUT "STOP FREQUENCY? (MHZ)",Table(I,2)	
310	INPUT "NUMBER OF POINTS?",Table(I,3)	Enter the segment values.

```
320  IF Table(I,3)=1 THEN
      Table(I,2)=Table(I,1)

330  PRINT TABXY(0,I+1);I;
      TAB(10);Table(I,1);
      TAB(20);Table(I,2);
      TAB(30),Table

340  RETURN

350  END
```

If only one point in the segment, make the stop frequency equal to the start frequency to avoid ambiguity.

Print the segment out. If a segment is being edited, TABXY, will print over old segments.

### Running the program

The program displays the frequency list table as it is entered. During editing, the displayed table is updated as each line is edited. The table is not re-ordered. At the completion of editing, the table is entered into the network analyzer, and list frequency mode turned on. During editing, pressing [RETURN] leaves an entry at the old value.

Any segments already in the list frequency table in the network analyzer will be deleted by the program. If not wanted, delete lines 40 thru 60. New segments will write over the old ones.

## Example 4B: Selecting a single segment from a table of segments

This example program shows how a single segment can be chosen to be the operating frequency range of the network analyzer, out of a table of segments. The program assumes that a list frequency table has already been entered into the network analyzer, either manually, or using the program in Example 4A, Setting up a list frequency sweep.

The program first loads the list frequency table into the computer by reading the start and stop frequencies of each segment, and the number of points for each segment. The segments' parameters are then displayed on the computer screen, and the user can choose which segment is to be used by the analyzer. Note that only one segment can be chosen at a time.

This program is stored on the Example Programs disk as **IPG4B**.

10	ABORT 7	
20	CLEAR 716	Prepare for HP-IB control
30	PRINTER IS 1	Make sure we print on the screen.
40	OUTPUT 2;CHR\$(255)\$"K";	Clear the screen.
50	PRINT USING "10A,15A,15A,20A"; "SEGMENT", "START (MHZ)", "STOP (MHZ)", "NUMBER OF POINTS"	Print out the table header.
60	OUTPUT 716;"EDITLIST"; SEDI30;SEDI;"	Interrogate the number of the highest segment. This allows the program to determine the number of list frequency segments.
70	ENTER 716;Numsegs	Read the active parameter (segment number) into the variable Numsegs.
80	ALLOCATE Table(1:Numsegs, 1:3)	Create an array large enough to hold all the segment parameters.
90	FOR I=1 to Numsegs	This FOR NEXT loop calls the subroutine Readlist which reads in the segment parameters
100	GOSUB Readlist	
110	NEXT I	
120	LOOP	Use the LOOP structure to allow continuous selection of the desired segment to be measured.
130	INPUT "SELECT SEGMENT NUMBER: (0 TO EXIT)",Segment	
140	EXIT IF Segment=0	Allow the operator to exit the loop by entering 0 as the segment number.
150	OUTPUT 716;"SSEG"; Segment;" ;EDITDONE;"	The SSEG command causes the specific segment to become the new operating frequency range of the measurement.
160	END LOOP	
170	OUTPUT 716;"ASEG;"	When the loop is exited, resume operation using all list frequency segments. The ASEG command turns on all the segments.
180	DISP "PROGRAM ENDED"	
190	STOP	

200	Readlist: !	This subroutine reads out all the segment parameters.
210	OUTPUT 716;"EDITLIST; SEDI;" ,I, ";"	Activate the Ith segment.
220	OUTPUT 716;"STAR; OUTPACTI;"	Make the start frequency active, and output its value using the OUTPACTI command.
230	ENTER 716;Table(I,1)	Read the start frequency into the list table.
240	OUTPUT 716;"STOP; OUTPACTI;"	Make the stop frequency active, and output its value.
250	ENTER 716;Table(I,2)	Read the stop frequency value.
260	OUTPUT 716;"POIN; OUTPACTI;"	Make the number of points active, and output its value.
270	ENTER 716;Table(I,3)	Read the number of points.
280	IF I=18 THEN INPUT "HIT RETURN FOR MORE",A\$	Stop printing when 17 segments have been listed on the display, this allows the operator to examine the first 17 segments before they are scrolled off the computer display by addition segments (remember, there are up to 30 segments).
290	IMAGE 4D,6X,4D.6D,3X, 4D.6D,3X,4D	Specify the print format and margins for the list frequency table.
300	PRINT USING 290;I;Table (I,1)/1.E+9; Table(I,2)/ 1.E+9;Table(I,3)	Print out the segment parameters for the Ith segment.
310	RETURN	
320	END	

## Running the program

The program will read the parameters for each list frequency segment from the network analyzer, and build a table containing all the segments. The parameters of each segment will be printed on the computer screen. If there are more than 17 segments, the program will pause. Press [RETURN] to see more segments. The maximum number of segments that can be read is 30 (which is the maximum number of segments that the network analyzer can hold). Use the computer's [Prev] and [Next] keys to scroll the list of segments back and forth if there are more than 17 segments.

After all the segments are displayed, the program will prompt for a specific segment to be used. Type in the number of the segment, and the network analyzer will then "zoom-in" on that segment. The program will continue looping, allowing continuous selection of different segments. To exit the loop, type 0. This will restore all the segments (with the command ASEG), allowing the network analyzer to sweep all of the segments, and the program will terminate.

# Using limit lines to perform PASS/FAIL tests

There are two steps to performing limit testing on the network analyzer under HP-IB control. First, limit specifications must be specified and loaded into the analyzer. Second, the limits are activated, the device is measured, and its performance to the specified limits is signaled by a pass or fail message on the network analyzer's display.

Example 5A illustrates the first step, setting up limits, and Example 5B performs the limit testing.

## Example 5A: Setting up limit lines

This example shows how to create a limit table and transmit it to the network analyzer.

The command sequence for entering a limit table imitates the key sequence followed when entering a table from the front panel: there is a command for every key press. Editing a limit is also the same as the key sequence, but remember that the network analyzer automatically re-orders the table in order of increasing start frequency.

The limit table is also carried as part of the learn string. While it cannot be modified as part of the learn string, it can be stored and recalled with very little effort.

This example takes advantage of the computer's capabilities to simplify creating and editing the table. The table is entered and completely edited before being transmitted to the network analyzer. To simplify the programming task, options such as entering offsets are not included.

This program is stored as **IPG5A** on the Example Programs disk.

10	ABORT 7	
20	CLEAR 716	Prepare the network analyzer for HP-IB control.
30	OUTPUT 716;"EDITLIML; CDEL; "	Delete any existing limits.
40	INPUT "Number of limits?",Numb	Find out how many limits to expect.
50	ALLOCATE Table(1:Numb,1:3)	Create a table to hold the limits. It will contain stimulus value (frequency), upper limit value, and the lower limit value.
60	ALLOCATE Limtype\$(Numb) (2)	Create a string array to indicate the limit types.
70	PRINTER IS 1	Make sure we print on the screen.
80	OUTPUT 2;CHR\$(255)&"K";	Clear the screen.
90	PRINT USING "10A,20A,15A,20A";"SEG", "STIMULUS(MHZ)", "UPPER (dB)", "LOWER (dB)", "TYPE"	Print the table header.
100	FOR I=1 TO Numb	Read in each segment.
110	GOSUB Loadlimit	Loadlimit (line 310) reads in the stimulus value (frequency), upper value, lower value, and the limit type for limit I. Since Loadlimit is a subroutine, I is used as a global variable.

120	NEXT I	Use the LOOP, EXIT IF, END LOOP structure to loop and edit the table until the operator indicates that editing is no longer desired. This structure sets up a loop with the exit point in the middle of the loop rather than at the beginning (as with WHILE, END WHILE), or at the end (as with REPEAT, UNTIL).
130	LOOP	
140	INPUT "DO YOU WANT TO EDIT? Y OR N",An\$	Edit the table. Editing is re-entering the entire limit. The old limit values are left in place if return is pressed without typing anything.
150	EXIT IF An\$="N"	Exit the edit loop if editing is finished. Execution is continued at line 190.
160	INPUT "ENTRY NUMBER?",I	For editing, get the entry number.
170	GOSUB Loadlimit	And have Loadlimit re-enter the values.
180	END LOOP	
190	OUTPUT 716;"EDITLIML;"	Begin the table entry by opening the limit table for editing. The limit table must be empty, or these limits will just be added on top of the old ones.
200	FOR I=1 TO Numb	Loop for each limit.
210	OUTPUT 716;"SADD;LIMS"; Table(I,1);"MHZ;"	Enter the stimulus value.
220	OUTPUT 716;"LIMU";Table (I,2);"DB;"	Enter the upper limit value.
230	OUTPUT 716;"LIML",Table (I,3),"DB;"	Enter the lower limit value.
240	IF Limtype\$(I)="FL" THEN OUTPUT 716;"LIMITFL;"	Set flat limit type.
250	IF Limtype\$(I)="SL" THEN OUTPUT 716;"LIMITSL;"	Set sloped limit type.
260	IF Limtype\$(I)="SP" THEN OUTPUT 716;"LIMITSP;"	Set point limit type.
270	OUTPUT 716;"SDON;"	Declare the limit done.
280	NEXT I	
290	OUTPUT 716;"EDITDONE; LIMILINEON;LIMITESTON;"	Close the table, display the limits, and activate limit testing.
300	STOP	
310	Loadlimit: !	Enter in a segment.
320	INPUT "STIMULUS VALUE? (MHZ)",Table(I,1)	
330	INPUT "UPPER LIMIT VALUE (DB)?",Table(I,2)	
340	INPUT "LOWER LIMIT VALUE (DB)?",Table(I,3)	Enter the limit values.
350	INPUT "LIMIT TYPE" (FL=FLAT, SL=SLOPED, SP=SINGLE POINT)",Limtype\$(I)	Enter the limit type.



```
360 PRINT TABXY(0,I+1);I;  
    TAB(10); Table(I,1);  
    TAB(30); Table(I,2);  
    TAB(45),Table(I,3),  
    TAB(67); Limtype$(I)  
  
370 RETURN  
  
380 END
```

Print the limit values out. Because of the TABXY, this will print over old limits if a limit is being edited.

### Running the program

The program displays the limit table as it is entered. During editing, the displayed table is updated as each line is edited. The table is not reordered. When editing is done, the table is entered into the network analyzer, and limit testing mode turned on. During editing, pressing [RETURN] leaves an entry at the old value.

This example program will delete any existing limit lines before entering the new limits. If this is not wanted, omit lines 30 through 50.

## Example 5B: Performing PASS/FAIL tests while tuning

The purpose of this example is to demonstrate the use of the limit/search fail bits in event status register B, to determine whether a device passes the specified limits. Limits can be entered manually, or using the Example 5A.

The limit/search fail bits are set and latched when limit testing or a marker search fails. There are four bits, one for each channel for both limit testing and marker search. Their purpose is to allow the computer to determine whether the test/search just executed was successful. The sequence of their use is to clear event status register B, trigger the limit test or marker search, and then check the appropriate fail bit.

In the case of limit testing, the best way to trigger the limit test is to trigger a single sweep. By the time the SING command finishes, limit testing will have occurred. A second consideration when dealing with limit testing is that if the device is tuned during the sweep, it may be tuned into and then out of limit, causing a limit test pass when the device is not in fact within limits.

In the case of the marker searches (max, min, target, and widths), outputting marker or bandwidth values automatically triggers any related searches. Hence, all that is needed is to check the fail bit after reading the data.

In this example, the requirement that several sweeps in a row must pass is used in order to give confidence that the limit test pass was not extraneous due to the device settling or the operator tuning during the sweep. Upon running the program, the number of passed sweeps for qualification is entered. For very slow sweeps, a small number of sweeps such as two is appropriate. For very fast sweeps, where the device needs time to settle after tuning and the operator needs time to get away from the device, as many sweeps as six or more sweeps might be appropriate.

A limit test table can be entered over HP-IB: the sequence is very similar to that used in entering a list frequency table and is shown in Example 5A. The manual sequence is closely followed.

This program is stored under **IPG5B** on the Example Programs disk.

10	ABORT 7	
20	CLEAR 716	Prepare the network analyzer for remote control.
30	INPUT "Number of consecutive passed sweeps for qualification?",Qual	Find out how many sweeps must pass before the device is considered to have passed the limit test.
40	DISP "TUNE DEVICE"	Tell operator to begin tuning.
50	Reap=0	Reap is a counter holding how many sweeps have passed the limit test.
60	OUTPUT 716;"OPC?;SING;"	Take a sweep. When it is done, limit test will have occurred.
70	ENTER 716;Reply	Wait for the end of the sweep.
80	OUTPUT 716;"ESB?;"	Check to see if the fail bit is set.
90	ENTER 716;Estat	
100	IF BIT(Estat,4) THEN	If the fail bit for channel one is set, reset the number of sweeps passed counter.
110	IF Reap<\$GTO THEN BEEP 1200,.05	If sweeps had been passing, warn the operator that the device is now failing.
120	Reap=0	
130	GOTO 40	

140	END IF	If the fail bit was not set, tell the operator.
150	BEEP 2500, .01	
160	Reap=Reap+1	Increment the sweeps passed counter.
170	DISP "STOP TUNING"	Encourage the operator to stop tuning the device.
180	IF Reap<Qual THEN GOTO 60	If not enough sweeps have passed, loop.
190	DISP "DEVICE PASSED!"	The device has passed.
200	FOR I=1 TO 10	Warble, telling the operator the device has passed, using an audible signal.
210	BEEP 1000, .05	
220	BEEP 2000, .01	
230	NEXT I	
240	INPUT "HIT RETURN FOR NEXT DEVICE", Dum\$	Wait for the next device.
250	GOTO 40	
260	END	

### Running the program

Set up a limit table on channel 1 for a specific device either manually, or using the program in Example 5A. Run the program, and enter the number of passed sweeps desired for qualification. After entering the qualification number, connect the filter. When a sweep passes, the computer beeps. When enough sweeps in a row pass to qualify the device, the computer warbles and asks for a new device.

The program assumes a response calibration (thru calibration) or full 2-port calibration has been performed prior to running the program. Try causing the DUT to fail by loosening the cables connecting the DUT to the network analyzer, and then retightening them.

## Storing and recalling instrument states

This example demonstrates ways of storing and recalling entire instrument states over HP-IB. The methods discussed are to use the learn string, and the computer to coordinate direct store/load of instrument states to disk.

Using the learn string is a quick way of saving the instrument state, but using direct disk access will automatically store calibrations, cal kits, and data along with the instrument state.

### Example 6A: Using the learn string

The learn string is a fast and easy way to read an instrument state. The learn string includes all front panel settings, the limit table for each channel, and the list frequency table. The learn string is read out with OUTPLEAS, and put back into the instrument with INPULEAS. The string is in form 1, and is no longer than 3000 bytes long.

This example program is stored on the Example Programs disk as IPG6A.

10	DIM State\$(3000)	Set up the receive string.
20	OUTPUT 716;"OUTPLEAS;"	Request the learn string.
30	ENTER 716 USING "-K";State\$	Read in the learn string. Normally, the enter statement will terminate if a line feed is received, so USING "-K" is used, which allows termination only on End Or Identify.
40	LOCAL 716	Put the analyzer in LOCAL mode.
50	INPUT "CHANGE STATE AND HIT RETURN",Dum\$	Give the operator a chance to modify the state or connect a new analyzer.
60	OUTPUT 716;"INPULEAS"; State\$	Transmit the state back to the HP 8753B.
70	DISP "INITIAL INSTRUMENT STATE RESTORED"	
80	END	

### Running the program

Run the program. When the program stops, change the instrument state and press [RETURN]. The network analyzer will return its original state.

When using a learn string from an HP 8753B, additional commands are needed because the "old" string is shorter. Therefore, you must tell the network analyzer when the transfer of the string has reached completion (sending EOI concurrently with the last byte of information).

The following program will output an HP 8753B learn string (previously obtained and put in State\$) to an HP 8753C:

10	OTHER CODE WHICH HAS State\$	
.	.	
.	.	
100	EOI\$=";"	
120	ASSIGN@Ana to 716; EOL EOI\$	This syncs EOI (End or Identify) with a semicolon as the last character in the string.
	END	
130	OUTPUT@Ana; "INPULEAS";State\$	
140	DISP "8753B Learn String State"	
150	END	

## Example 6B: Coordinating disk storage

To have the network analyzer store an instrument state on disk, specify the state name by titling a file using TITFn, then specify a STORn of that file, where n is the file number, 1 to 5. On receipt of the store command, the network analyzer will request active control. When control is received, the network analyzer will store the instrument state on disk as defined under the [DEFINE STORE] menu.

To have the network analyzer load a file from disk, specify the state name, and then request a LOADn of that file. The best way of learning what the register titles on the disk are, is to use the [READ FILE TITLES] under the [RECALL] key.

This example program is stored on the Example Programs disk as **IPG6B**.

10	ABORT 7	
20	CLEAR 716	Prepare the network analyzer for remote control.
30	INPUT "STATE TITLE? PRESS RETURN",Nam\$	Get the name of the file to create.
40	OUTPUT 716;"USEPASC;"	Tell the network analyzer to use pass control mode.
50	OUTPUT 716;"TITF1"""; Nam\$;"";STOR1;"	Title register 1, and store it. The title must be preceded and followed by double quotation marks, and the only way to do that with an output statement is to use two sets of quotation marks: "".
60	DISP "SAVING ON DISC"	
70	SEND 7;TALK 16 CMD 9	Pass control to the network analyzer, assuming it has interpreted the STOR1 command and set the request control bit.
80	STATUS 7,6;Stat	
90	IF NOT BIT(Stat,6) THEN GOTO 80	Wait for active control to return.
100	INPUT "STATE STORED. HIT RETURN TO RECALL",Dum\$	
110	INPUT "STATE TITLE?",Nam\$	Get the name of the file to read.
120	OUTPUT 716;"TITF1"""; Nam\$;"";LOAD1;"	Title register one, and request a load.
130	DISP "READING DISC"	
140	SEND 7;TALK 16 CMD 9	Pass control.
150	STATUS 7,6;Stat	
160	IF NOT BIT(Stat,6) THEN GOTO 150	Wait for control to return.
170	DISP "DONE"	The program is done, and the state has been loaded back into the instrument.
180	END	

### Running the program

Put a formatted disk in the disk drive, and point the network analyzer's disk address, unit number, and volume number toward that drive. Run the example, and when the program pauses, change the instrument state so that a change will be noticeable. Pressing return will recall the state just stored, or a completely different state can be recalled.

## Example 6C: Reading calibration data

This example demonstrates how to read measurement calibration data out of the network analyzer, how to put it back into the instrument, and how to determine which calibration is active.

The data used to perform measurement error correction is stored inside the network analyzer in up to twelve calibration coefficient arrays. Each array is a specific error coefficient, and is stored and transmitted as an error corrected data array: each point is a real/imaginary pair, and the number of points in the array is the same as the number of points in the sweep. The four data formats also apply to the transfer of calibration coefficient arrays. Appendix C, Calibration, of the HP-IB Quick Reference specifies where the calibration coefficients are stored for different calibration types.

A computer can read out the error coefficients using the commands OUTPCALC01, OUTPCALC02, . . . OUTPCALC12. Each calibration type uses only as many arrays as needed, starting with array 1. Hence, it is necessary to know the type of calibration about to be read out: attempting to read an array not being used in the current calibration causes the "REQUESTED DATA NOT CURRENTLY AVAILABLE" warning.

A computer can also store calibration coefficients in the network analyzer. To do this, declare the type of calibration data about to be stored in the network analyzer just as if you were about to perform that calibration. Then, instead of calling up different classes, transfer the calibration coefficients using the INPUCALCnn commands. When all the coefficients are in the network analyzer, activate the calibration by issuing the mnemonic SAVC, and have the network analyzer take a sweep.

This example reads the calibration coefficients into a very large array, from which they can be examined, modified, stored, or put back into the instrument. If the data is to be directly stored onto disk, it is usually more efficient to use form 1 (network analyzer internal binary format), and to store each coefficient array as it is read in.

This program is stored on the Example Programs disk as **IPG6C**.

10	ABORT 7	
20	CLEAR 716	Prepare the network analyzer for HP-IB control.
30	DATA "CALIRESP",1, "CALIRAI",2, "CALIS111",3	
40	DATA "CALIS221",3, "CALIFUL2",12	
50	DATA "NOOP",0	Set up the data base of possible calibrations, and the number of arrays associated with each calibration.
60	INTEGER Hdr,Lgth,I,J	Define integers to hold the header, and to act as counters.
70	ASSIGN @Dt TO 716;FORMAT OFF	
80	READ Calt\$,Numb	Get a calibration type and the number of associated arrays.
90	IF Numb=0 THEN GOTO 360	If correction was not on, stop the program.
100	OUTPUT 716;Calt\$;"?;"	Interrogate the network analyzer to see if this calibration is active.
110	ENTER 716;Active	
120	IF NOT Active THEN GOTO 80	If the calibration was not active, loop.
130	DISP Calt\$,Numb	Show the operator that we have found the calibration and number of arrays.
140	OUTPUT 716;"FORM3;POIN?;"	Find out how many points to expect.

150	ENTER 716;Poin	
160	ALLOCATE Cal(1:Numb,1: Poin,1:2)	Create a very large array to hold all the coefficients.
170	FOR I=1 TO Numb	Loop once for each calibration coefficient.
180	OUTPUT 716 USING "K,ZZ";"OUTPCALC",I	Request the calibration coefficient. The K transmits OUTPCALC literally, and ZZ transmits I as two digits, using a leading zero if needed.
190	ENTER @Dt;Hdr,Lgth	Read the header.
200	FOR J=1 TO Poin	
210	ENTER @Dt; Cal(I,J,1),Cal(I,J,2)	Since we are not filling the entire array, we have to read each point individually.
220	NEXT J	
230	NEXT I	The calibration data is now all in the computer.
240	INPUT "HIT RETURN TO RE-TRANSMIT CALIBRATION", Dum\$	
250	OUTPUT 716;Calt\$,";"	Begin the calibration retransmission by declaring what calibration type is about to be loaded.
260	FOR I=1 TO Numb	Now load each calibration coefficient.
270	DISP "TRANSMITTING ARRAY: ",I	
280	OUTPUT 716 USING "K,ZZ"; "FORM3;INPUCALC",I	
290	OUTPUT @Dt;Hdr,Lgth	
300	FOR J=1 TO Poin	
310	OUTPUT @Dt;Cal(I,J,1),Cal(I,J,2)	
320	NEXT J	
330	NEXT I	All of the calibration data has been loaded.
340	OUTPUT 716;"SAVC;"	End the sequence by activating the calibration.
350	OUTPUT 716;"CONT;"	Trigger a sweep so the calibration becomes active.
360	DISP "DONE"	
370	END	

## Running the program

Before executing the program, perform a calibration.

The program is able to detect what calibration is active, and with that information it predicts how many arrays to read out. When all the arrays are inside the computer, the program prompts the user. At this point, turn calibration off, or perform a completely different calibration on the network analyzer. Then press continue on the computer, and the computer will reload the old calibration.

Note that the retransmitted calibration is associated with the current instrument state: the instrument has no way of knowing the original state associated with the calibration data. For this reason, it is recommended that the learn string be used to store the instrument state whenever calibration data is stored. See Example 6A, *Using the learn string*.

# Miscellaneous Programming Examples

## Controlling peripherals

The purpose of this section is to demonstrate how to coordinate printers, plotters, power meters, and disk drives with the network analyzer.

The network analyzer has three operating modes with respect to HP-IB, as set under the [LOCAL] menu. System controller mode is used when no computer is present. The other two modes allow the computer to coordinate certain actions: in talker/listener mode the computer can control the network analyzer, as well as coordinate plotting and printing, and in pass control mode the computer can pass active control to the network analyzer so that the network analyzer can plot, print, control a power meter, or load/store to disk. Peripheral control is the major difference between the two modes.

Note that the network analyzer assumes that the address of the computer is correctly stored in its HP-IB addresses menu under the [ADDRESS: CONTROLLER] entry. If this address is incorrect, control will not return to the computer. If control is passed to the network analyzer while it is in talker/listener mode, control will not return to the computer.

### Example 7: Operation using pass control mode

If the network analyzer is in pass control mode and receives a command telling it to plot, print, control a power meter, or store/load to disk, it sets bit 1 in the event status register to indicate that it needs control of the bus. If the computer then uses the HP-IB control command to pass control to the network analyzer, the network analyzer will take control of the bus, and access the peripheral. When the network analyzer no longer needs control, it will pass it back to the computer. When performing a power meter cal over HP-IB, the network analyzer requests control at each measurement point in a sweep which is typically \$ae3\* the number of readings.

Control should not be passed to the network analyzer before it has set event status register bit 1, Request Active Control. If the network analyzer receives control before the bit is set, control is passed immediately back.

While the network analyzer has control, it is free to address devices to talk and listen as needed. The only functions denied it are the ability to assert the interface clear line (IFC), and the remote line (REN). These are reserved for the system controller. As active controller, the network analyzer can send messages to and read replies back from printers, plotters, and disk drives.

This example prints the display. It is stored on the Example Programs disk as IPG7B. The program could request a plot with PLOT, or a disk access with a command such as REFT (read file titles.)

10	OUTPUT 716;"CLES;ESE2;"	Clear the status reporting system, and enable the Request Active Control bit in the event status register.
20	OUTPUT 716;"USEPASC; PRINALL;"	Put the network analyzer in pass control mode, and request a print.
30	Stat=SPOLL(716)	Get the status byte of the network analyzer.
40	IF NOT BIT(Stat,5) THEN GOTO 30	If the network analyzer is not requesting control, loop and wait. If using color printer, use COLOP.
50	SEND 7;TALK 16 CMD 9	This is the bus command to pass active control to device 16. With BASIC 3.0 or higher, or 2.0 with extensions 2.1, the command PASS CONTROL 716 can be used instead.



60	DISP "PRINTING"	
70	STATUS 7,6;Hpib	To determine when the print is finished, watch for return of active control. The STATUS command loads the interface 7 (HP-IB) register 6, the computer's status with respect to HP-IB, into the variable Hpib. Bit 6 tells if the computer is the active controller: it will be set when the network analyzer returns control.
80	IF NOT BIT(Hpib,6) THEN GOTO 70	If control has not returned, loop and wait.
90	DISP "DONE"	Control has returned.
100	END	

### Running the program

The network analyzer will briefly flash the message WAITING FOR CONTROL, before receiving control and making the print. The computer will display the PRINTING message.

When the print is complete, the network analyzer passes control back to the address stored as the controller address under the [LOCAL] [SET ADDRESSES] menu. The computer will detect the return of active control and exit the wait loop.

Because the program waits for the network analyzer's request for control, it can be used to respond to front panel requests as well. Delete PRINALL; from line 20, and run the program. Nothing will happen until you go to the front panel of the network analyzer and request a print, plot, or disk access. For example, press [LOCAL] [COPY] and [PRINT].

## Example 8: Creating a user interface

This example shows how to create a custom user interface involving only the front panel keys and display of the network analyzer.

### User graphics

The network analyzer's display can be treated as an HP-GL plotter. The BASIC graphics commands can be used to create a custom display. Some of the more useful commands are as follows. VIEWPORT defines what area of the display is to be plotted on. WINDOW allows you to specify the plotting units (i.e. how many units per axis) in the VIEWPORT defined area. DRAW draws lines from point to point. MOVE moves the logical pen without drawing anything. GCLEAR clears the graphics display area. PEN selects the line color.

All of the BASIC graphics statements are accepted. The LABEL statement is not recommended because it fills the display memory up very rapidly as opposed to when the HP-GL LB command is used. See the Waitforkey subroutine of Example 2A for an example of the LB command.

HP-GL (Hewlett-Packard Graphics Language) commands, such as the LB command mentioned above, can be directly sent to the network analyzer display with the OUTPUT statement. See Appendix D, *Display Graphics*, of the *HP-IB Quick Reference* for a list of the HP-GL commands accepted, and their functions.

### Front panel control

It is possible to take over the front panel keys. The user request bit in the event status register is set whenever a front panel key is pressed or the knob is turned, whether the instrument is in remote or local mode. Each key has a number associated with it, as shown in Figure E.4, *Front Panel Keycodes* of the *HP-IB Quick Reference*. The number of the key last pressed can be read with the KOR? and the OUTPKEY? commands. With KOR?, a knob turn is reported as a negative number encoded with the number of counts turned. With OUTPKEY?, a knob turn is always reported as a negative one.

The keycode encoding with KOR? is as follows. Clockwise rotations are reported as numbers from -1 to -64, -1 being a very small rotation. Counter-clockwise rotations are reported as the numbers -32,767 to -32,703, -32,767 being a very small rotation. Hence, clockwise rotations don't need any decoding at all, and counter-clockwise rotations can be decoded by adding 32,768.

There are approximately 120 counts per knob rotation, and sign of the count depends on the direction the knob was turned.

This example uses the knob and the up and down keys on the network analyzer to position a grid on the display. Pressing [ENTRY OFF] on the network analyzer causes the computer to put a trace on the grid.

This example program is stored on the Example Programs disk as **IPG8**.

10	INTEGER Hdr,Lgth,Keyc	Declare variables to hold the header and the key code.
20	ASSIGN @Dt TO 716;FORMAT OFF	Define an IO path with formatting off, to receive the form 3 trace data for plotting.
30	OUTPUT 716;"HOLD;AUTO; CLES;ESE 64;POIN?;"	Prepare the instrument. HOLD;AUTO; freezes and scales the trace for plotting. CLES;ESE 64; clears the status reporting system and enables the User Request bit in the event status register. Lastly, POIN?; requests the number of points.

40	ENTER 716;POIN	Read in the number of points.
50	GINIT	Initialize the graphics functions in the computer.
60	PLOTTER IS 717, "HPGL"	Specify the network analyzer display as the plotting device.
70	OUTPUT 717; "CS; SP3; "	Turn off the measurement display and set the rectangle color to that of channel 2 data.
80	Cx=55	Initialize the x position of the center of the rectangle.
90	Cy=60	Initialize the y position of the center of the rectangle.
100	S=20	Set the size of the rectangle.
110	REPEAT	The REPEAT, UNTIL structure sets up a loop that keeps repeating until the condition specified in the UNTIL statement is found to be true. The condition is checked at the end of the loop. In this case, loop and redraw the rectangle until [ENTRY OFF] has been pressed.
120	GCLEAR	Clear the graphics area on the network analyzer.
130	IF Cx\$GT160 THEN Cx=160	Prevent box from going off the screen.
140	IF Cx<-17 THEN Cx=-17	Note that these values are linked to the increments set in lines 270/310 and 320!
150	IF Cy\$GT115 THEN Cy=115	
160	IF Cy<-15 THEN Cy=-15	
170	VIEWPORT Cx-S, Cx+S, Cy-S, Cy+S	Define the area of the rectangle, which will become the plotting area for the grid and trace.
180	WINDOW 0, Poin-1, 0, 1	Define the units along the edges of the rectangle. In this case, the horizontal edge has as many units as points in the sweep, and the vertical edge is simply unity.
190	FRAME	Draw the rectangle around the plotting area.
200	Stat=SPOLL(716)	Read the status byte.
210	IF NOT BIT(Stat, 5) THEN GOTO 200	If bit 5 is not set, a key has not been pressed, so loop and wait.
220	OUTPUT 716; "ESR?; "	A key press has occurred, so read the event status register in order to clear the latched bit.
230	ENTER 716; Estat	Read in the register value, but do nothing with it.
240	OUTPUT 716; "KOR?; "	Now read in the key or knob count.
250	ENTER 716; Keyc	
260	IF Keyc=26 THEN Cy=Cy+5	Key 26 is the up key, so shift the rectangle up.
270	IF Keyc=18 THEN Cy=Cy-5	Key 18 is the down key, so shift the rectangle down.

280	IF Keyc<0 THEN	If the keycode was negative, then it is a knob count.
290	Knb=Keyc	Decode the knob count into the variable Knb.
300	IF Knb<-64 THEN Knb=Knb+32768	If the count is less than -64, add 32768 (2 <sup>15</sup> ) to recover the knob count. If the count is more than -64, then no decoding is needed.
310	x=Cx-Knb*3C	Shift the rectangle according the knob count, multiplying the knob count to make the rectangle move farther.
320	END IF	
330	UNTIL Keyc=34	This is the end of the REPEAT, UNTIL structure. Leave the loop only when key 34, [ENTRY OFF] has been pressed.
340	GRID (Poin-1)/10,.1	[ENTRY OFF] has been pressed, so draw the grid and the trace. This statement draws a grid with 10 divisions on each axis.
350	OUTPUT 717;"SP1;"	Set the trace color to that of channel 1 data.
360	OUTPUT 716;"FORM3;OUTPFORM;"	Now get the trace data.
370	ENTER @Dt;Hdr,Lgth	Get the header information.
380	ALLOCATE Dat(1:Poin,1:2)	Define the receiving array.
390	ENTER @Dt;Dat(*)	And read in the data.
400	OUTPUT 716;"SCAL?;"	Instead of scaling the data in this program, interrogate the scale factor the network analyzer was using.
410	ENTER 716;Scal	
420	OUTPUT 716;"REFV?;"	Similarly, use the value at the reference position to decide where to draw the trace.
430	ENTER 716;Ref	
440	OUTPUT 716;"REFP?;"	Interrogate the current reference position being used.
450	ENTER 716;Refp	
460	Bot=Rev-Refp*Scal	Calculate the value of the bottom grid line.
470	Full=10*Scal	And define the full scale span across the grid.
480	MOVE 0,(Dat(1,1)-Bot)/Full	Go to the first point on the trace without drawing anything.
490	FOR I=1 TO Poin-1	And draw all the rest of the points in the trace.
500	DRAW I,(Dat(I,1)-Bot)/Full	
510	NEXT I	The trace is drawn, so end the program.
520	END	

## Running the program

Set the instrument up to make a measurement. The network analyzer will not accept a graphics dump of a trace of greater than 1601 points.

Run the program, and go to the front panel of the network analyzer. The measurement display has been turned off, and there is a box on the screen. The knob moves the box left and right, and the up/down keys move the box up and down. When you are satisfied with the position of the box, press **[ENTRY OFF]**. The computer will fill the box with a grid, and plot the current measurement data on the grid.

## Transferring disk data files

An external disk drive is often used to store data files in addition to instrument states (see Example 6B). Instrument states, graphics, data trace, calibration data, and memory trace files can be stored on disk. The file name is then appended with up to two characters to indicate what is in the file. For example, if channel 2 error-corrected data is saved to disk as DEVICE, the actual error-corrected data would be stored in DEVICED2. As with all data files stored on disk, they are stored in form 3. See Appendix E.3: *Disk file names* in the *HP-IB Quick Reference* for a complete list of the types of files saved to disk and the corresponding appendages to file names.

### Example 9: Reading data files into a computer

This example demonstrates how to recall a specific disk file into a computer. First, EXT-MADTAON defines the storage of the current trace as error-corrected data. After the file is stored to disk, the computer reads the error-corrected data into an array. The program can easily be modified to read and transfer raw data, memory traces, and formatted data.

10	ABORT 7	
20	CLEAR 716	Prepare the network analyzer for remote control.
30	INPUT "STATE TITLE?", Nam\$	Get the name of the file to create.
40	OUTPUT 716; "USEPASC; "	Tell the network analyzer to use pass control mode.
50	OUTPUT 716; "TITF1"""; Nam\$; """; EXTMDATAON; STOR1; "	Title register 1, and store the instrument state and error-corrected data. The title must be preceded and followed by double quotation marks. The only way to do this within an output statement is to use two sets of quotation marks: " ".
60	DISP "SAVING ON DISC"	
70	SEND 7; TALK 16 CMD 9	Pass control to the network analyzer, assuming it has interpreted the STOR 1 command and set the request control bit.
80	STATUS 7, 6; Stat	
90	IF NOT BIT(Stat, 6) THEN GOTO 80	Wait for active control to return.
100	DISP "READING DATA INTO Disc_dat ARRAY"	
110	ASSIGN @Dt TO Nam\$&"D1"; FORMAT OFF	This statement defines an I/O path with ASCII formatting off. The I/O path points to the chosen error-corrected data file, and can be used to read or write data from the file, since it is in binary rather than ASCII format.
120	ALLOCATE Disc\$zdat(1:201, 1:2)	Allocate an array for a 201 point data trace. Real and imaginary pairs will be transferred for each data point.
130	ENTER @Dt; Disc_dat(*)	The computer takes the data from disk and transfers it into the receiving array. By specifying Disc_dat (*), the ENTER statement will fill every location in the array.
140	ASSIGN @Dt TO *	Close the I/O path.

```
150  DISP Disc_dat(1,1),          Show the first real imaginary pair.  
      Disc_dat(1,2)  
160  END                          End program execution.
```

### **Running the program**

A data file is stored to disk during program execution. Either remove the write-protection from the Example Programs disk or install a blank, formatted data disk. Perform a measurement calibration with 201 points. Connect a test device and run the program. The first/real imaginary pair will be displayed. Place a marker at the beginning of the trace and look at both real and imaginary formats to verify this point.

## Appendix A: Status Reporting

The network analyzer has a status reporting mechanism that gives information about specific functions and events inside the network analyzer. The status byte is an 8 bit register with each bit summarizing the state of one aspect of the instrument. For example, the error queue summary bit will always be set if there are any errors in the queue. The value of the status byte can be read with the SPOLL(716) statement. This command does not automatically put the instrument in remote mode, thus giving the operator access to the network analyzer front panel functions. The status byte can also be read by sending the command OUTPSTAT. Reading the status byte does not affect its value. The sequencing bit can be set by the operator during execution of a test sequence.

The status byte summarizes the error queue, as mentioned before. It also summarizes two event status registers that monitor specific conditions inside the instrument. The status byte also has bits that are set when the front panel preset key has been pressed, when the instrument is issuing a service request over HP-IB, and when the network analyzer has data to send out over HP-IB. See Figure A.1 for a definition of the status registers.

### Example A1: Using the error queue

The error queue holds up to 20 instrument errors and warnings in the order that they occurred. Each time the network analyzer detects an error condition and displays a message on the CRT, it also puts the error in the error queue. If there are any errors in the queue, bit 3 of the status byte will be set. The errors can be read from the queue with the OUTPERRO command, which causes the network analyzer to transmit the error number and the error message of the oldest error in the queue.

This example program is stored on the Example Programs disk as IPGA1.

10	DIM Err\$(50)	Prepare a string to hold the error message.
20	Stat=SPOLL(716)	Use the serial poll statement to read the status byte into the variable Stat. Serial poll is an HP-IB function dedicated specifically to getting the status byte of an instrument quickly, and does not cause the network analyzer to go into remote.
30	IF NOT BIT(Stat,3) THEN GOTO 20	If the error queue summary bit is not set, loop until it is set.
40	OUTPUT 716;"OUTPERRO;"	If the error queue has something in it, we instruct the network analyzer to output the error number and the error message. This communication with the network analyzer will put it in remote mode.
50	ENTER 716;Err,Err\$	Err holds the error number, Err\$ the error message.
60	PRINT Err,Err\$	
70	LOCAL 716	Return the network analyzer to local mode so that the front panel is available to the operator.
80	BEEP 600,.2	Give an audible signal that there is a problem.
90	GOTO 20	
100	END	



## Running the program

Preset the network analyzer and run the program. Nothing should happen at first. To get something to happen, press a blank softkey. The message "CAUTION: INVALID KEY" will appear on the network analyzer, the computer will beep and print two lines. The first line will be the invalid key error, and the second message will be the "NO ERRORS" message. Hence, to clean the error queue, you can either loop until the no errors message is received, or until the bit in the status register is cleared. In this case, we wait until the status bit is clear. Note that all through this, the front panel of the network analyzer is in local mode.

Because the error queue will keep up to 20 errors until either all the errors are read out or the instrument is preset, it is important to clear out the error queue whenever errors are detected so that old errors are not associated with the current instrument state.

Not all messages displayed by the network analyzer are put in the error queue: operator prompts and cautions are not included.

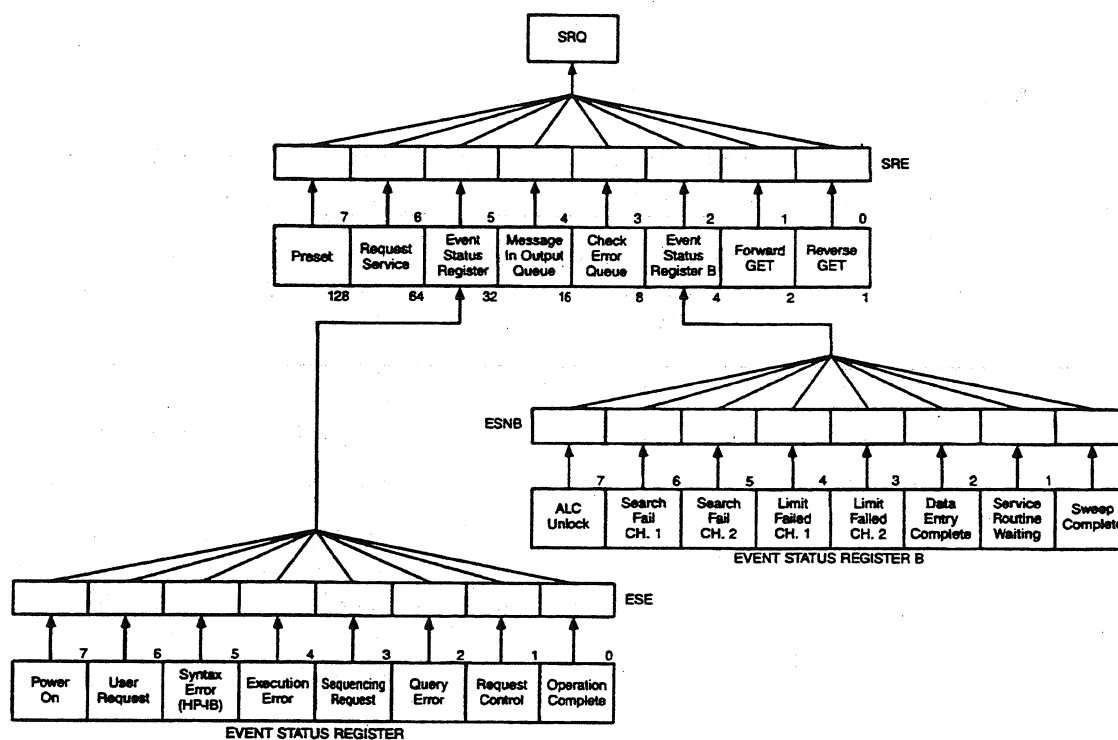

Figure A.1. Status reporting system

## Example A2: Using the status registers

The other key components of the status reporting system are the event status register, and event status register B. These 8 bit registers consist of latched event bits. A latched bit is set at the onset of the monitored condition, and is cleared by a read of the register or by clearing the status registers with CLES.

This example program is stored on the Example Programs disk as **IPGA2**

10	CLEAR 716	Clear out any old conditions.
20	OUTPUT 716;"ESR?;"	Read out the event status register.
30	ENTER 716;Estat	
40	IF NOT BIT(Estat,6) THEN GOTO 20	If the user request bit of the event status register is not set, loop back.
50	OUTPUT 716;"KOR?;"	If the user request bit has been set, there has been some front panel activity, and we read out the key code. The network analyzer's reply to KOR?; includes the knob count if the knob was turned. The information comes as a negative number, and has to be decoded.
60	ENTER 716;Keyc	
70	IF Keyc. $\geq$ 0 then PRINT "KEY ";	If the code was positive, it was a key press rather than a knob turn, and print the leader KEY. Placing a semicolon after the statement, suppresses the carriage return, line feed, allowing the code to be printed on the same line.
80	IF Keyc<-400 THEN Keyc=Keyc+32768	If the keycode is negative, it is a knob count. If it isn't less than -400, then the count is a clockwise rotation and needs no modification. If the count is less than -400, we have to add 32,768 ( $2^{15}$ ) to get the counter-clockwise count.
90	PRINT "CODE =",Keyc	Print the decoded key code.
100	GOTO 20	Wait for the next key press.
110	END	

### Running the program

Run the program. Pressing a key on the network analyzer causes the computer to display the keycode associated with that key. Note that since the network analyzer is in remote mode, the normal function of the key is not executed. In effect, we have taken over the front panel and can now redefine the keys.

### Example A3: Using the preset bit

The purpose of the preset bit is to aid test software in determining if and when the front panel preset key was pressed. To use this feature, bit 7 of the SRQ enable emask must be set.

Internally, the analyzer detects that bit 7 is being enabled and sets a flag in non-volatile memory. On any subsequent front panel preset, the analyzer will execute the normal preset functions, set the preset bit in the status register, check the non-volatile memory flag, and if it is set, generates an SRQ. Thus, bit 7 of the SRQ mask survives a preset. It is, however, reset on a power cycle.

This example is for clarification of the preset bit use. It is not contained on the Example Programs disk.

10	SRQmask=BINIOR(Srqmask,128)	Set bit 7 in srqmask variable.
20	OUTPUT 716;"CLES;"	Clear status registers.
30	OUTPUT 716;"SRE";Srqmask	Enable srq on preset.
40	ON INTR 7 GOSUB Isr	Setup interrupt routine.
50	ENABLE INTR 7;2	Allow the interrupt.
60	LOCAL 716	Allow control of front panel.
70	Idle:GOTO Idle	Wait in busy loop for preset.
80	STOP	
90	Isr:	
100	IF BIT(SPOLL(716),7) THEN	Check reason for srq.
110	PRINT "someone pressed the preset key"	
120	END IF	
130	OUTPUT 716;"CLES;"	Clear the interrupt.
140	ENABLE INTR 7;2	Re-enable interrupt.
150	LOCAL 716	
160	RETURN	
170	END	

## Example A4: Generating interrupts

It is also possible to generate interrupts using the status reporting mechanism. The status byte bits can be enabled to generate a service request (SRQ) when set. The 200/300 series computers can in turn be set up to generate an interrupt on the SRQ.

To be able to generate an SRQ, a bit in the status byte has to be enabled using SREn. A one in a bit position enables that bit in the status byte. Hence, SRE 8 enables an SRQ on bit 3, check error queue, since 8 equals 00001000 in binary representation. That means that whenever an error is put into the error queue and bit 3 gets set, the SRQ line is asserted, and the (S) indicator on the front panel of the network analyzer comes on. The only way to clear the SRQ is to disable bit 3, re-enable bit 3, or read out all the errors from the queue.

A bit in the event status register can be enabled so that it is summarized by bit 5 of the status byte. If any enabled bit in the event status register is set, bit 5 of the status byte will also be set. For example ESE 66 enables bits 1 and 6 of the event status register, since in binary, 66 equals 01000010. Hence, whenever active control is requested or a front panel key is pressed, bit five of the status byte will be set. Similarly, ESNBn enables bits in event status register B so that they will be summarized by bit 2 in the status byte.

To generate an SRQ from an event status register, enable the desired event status register bit. Then enable the status byte to generate an SRQ. For instance, ESE 32; SRE 32; enables the syntax error bit, so that when the syntax error bit is set, the summary bit in the status byte will be set, and it enables an SRQ on bit 5 of the status byte, the summary bit for the event status register.

The following example program is stored on the Example Programs disk as **IPGA3**.

```
10    OUTPUT 716;"CLES; ESE 32; SRE  Clear the status reporting system, and then
      32;"                               enable bit 5 of the event status register, and
                                          bit 5 of the status byte so that an SRQ will
                                          be generated on a syntax error.

20    ON INTR 7 GOTO Err                Tell the computer where to branch it gets
                                          the interrupt.

30    ENABLE INTR 7;2                    Tell the 200/300 series to enable an inter-
                                          rupt from interface 7 (HP-IB) when bit 1
                                          (value 2, the SRQ bit) of the interrupt regis-
                                          ter is set. If there is more than one instru-
                                          ment on the bus capable of generating an
                                          SRQ, it is necessary to use serial poll to de-
                                          termine which device has issued the SRQ.
                                          In this case, we assume the network analyz-
                                          er did it. A branch to Err will disable the
                                          interrupt, so the return from Err re-en-
                                          ables it.

40    GOTO 40                            Do nothing loop.

50    Err: !

70    OUTPUT 716;"ESR?;"                The interrupt has come in! Read the
                                          register to clear the bit.

80    ENTER 716;Estat

90    PRINT "SYNTAX ERROR DETECTED"

100   ENABLE INTR 7

110   GOTO 30

120   END
```

## Running the program

Preset the instrument, and run the program. The computer will do nothing. With the program still running, execute:

```
OUTPUT 716;"STIP 1 GHZ;"
```

The computer will display SYNTAX ERROR DETECTED, and the network analyzer will display CAUTION: SYNTAX ERROR, and display the incorrect command, pointing at the first character it did not understand.

The SRQ can be cleared by reading the event status register and hence clearing the latched bit, or by clearing the enable registers with CLES. The syntax error message on the network analyzer display can only be cleared by CLEAR 7 or CLEAR 716. CLEAR 7 is not commonly used because it clears every device on the bus.

Note that an impossible data condition does not generate a syntax error. For example, execute:

```
CLEAR 716  
OUTPUT 716;"STAR 10 HZ;"
```

The network analyzer simply sets the start frequency to 300 kHz, without generating a syntax error.

**For more information, call your local HP sales office listed in your telephone directory or an HP regional office listed below for the location of your nearest sales office.**

**United States:**

Hewlett-Packard Company  
4 Choke Cherry Road  
Rockville, MD 20850  
(301) 670-4300

Hewlett-Packard Company  
5201 Tollview Drive  
Rolling Meadows, IL 60008  
(312) 255-9800

Hewlett-Packard Company  
5161 Lankershim Blvd.  
No. Hollywood, CA 91601  
(818) 505-5600

Hewlett-Packard Company  
2015 South Park Place  
Atlanta, GA 30339  
(404) 955-1500

**Canada:**

Hewlett-Packard Ltd.  
6877 Goreway Drive  
Mississauga, Ontario L4V1M8  
(416) 678-9430

**Australia/New Zealand:**

Hewlett-Packard Australia Ltd.  
31-41 Joseph Street,  
Blackburn, Victoria 3130  
Melbourne, Australia  
(03) 895-2895

**Europe/Africa/Middle East:**

Hewlett-Packard S.A.  
Central Mailing Department,  
P.O. Box 529  
1180 AM Amstelveen,  
The Netherlands  
(31) 20/547 9999

**Far East:**

Hewlett-Packard Asia Ltd.  
22/F Bond Centre  
West Tower  
89 Queensway  
Central, Hong Kong  
(5) 8487777

**Japan:**

Yokogawa-Hewlett-Packard Ltd.  
29-21, Takaido-Higashi 3-chome  
Suginami-ku, Tokyo 168  
(03) 331-6111

**Latin America:**

Latin American Region Headquarters  
Monte Pelvoux Nbr. 111  
Lomas de Chapultepec  
11000 Mexico, D.F. Mexico  
(905) 596-79-33

**January 15, 1992**

Copyright © 1989  
Hewlett-Packard Company  
Printed in U.S.A.



# HP-IB Programming Guide



For the HP 8752A and HP 8753C Network Analyzers with the HP Vectra Personal Computer using Microsoft® QuickBASIC 4.5

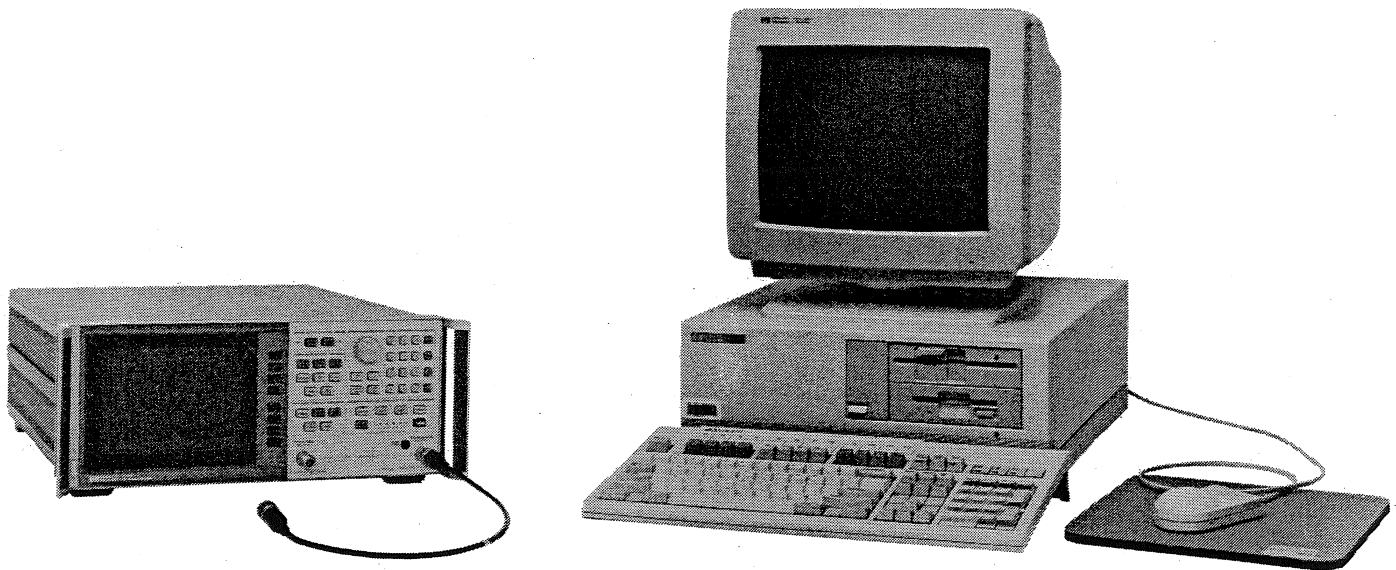

## Introduction

This programming guide is an introduction to remote operation of the HP 8752A and 8753C Network Analyzers with an HP Vectra Personal Computer (or IBM compatible) using the HP 82335A HP-IB Command Library and Microsoft QuickBASIC 4.5. This is a tutorial introduction, using programming examples to demonstrate the control of network analyzers with HP-IB commands. The example programs are on the Example Programs disk (part number 08753-10020) included with the operating manual. This document is closely associated with the *HP-IB Quick Reference* for the HP 8700-series network analyzers, which provides complete programming information in a concise format. Included in the *HP-IB Quick Reference* is an alphabetical list of HP-IB mnemonics and their explanations.

This note assumes that the reader is familiar with the operation of the network analyzer and the HP Vectra Personal Computer (or compatible), particularly HP-IB operation using the HP 82335A Command Library. This document is not intended to teach QuickBASIC programming or to discuss HP-IB theory except at an introductory level. See the section entitled *Reference information* for documents better suited to these tasks.

## Reference information

### HP 8752A/8753C Network Analyzer literature

*User's Guide*  
*Quick Reference*  
*Operating Manual*

### HP-IB and HP Vectra Personal Computer literature

*Tutorial Description of the Hewlett-Packard Interface Bus*  
*Condensed Description of the Hewlett-Packard Interface Bus*  
*HP 82335A HP-IB Command Library Manual*

### Microsoft QuickBASIC 4.5 literature

*Microsoft QuickBASIC: BASIC Language Reference*  
*Microsoft QuickBASIC: Learning and Using*  
*Microsoft QuickBASIC*  
*Microsoft QuickBASIC: Programming in BASIC:*  
*Selected Topics*

*Microsoft® is a U.S. registered trademark of Microsoft Corp.*

## Table of contents

Introduction .....	1
Notes on QuickBASIC .....	2
Basic Instrument Control .....	3
Measurement Programming .....	6
Basic Programming Examples: .....	8
Making measurements: .....	8
1. Setting up a basic measurement .....	8
Performing calibrations: .....	10
2A. 1-port calibration .....	11
2B. Full 2-port calibration (HP 8753C) .....	14
Transferring data: .....	19
3A. Data transfer using ASCII transfer format .....	22
3B. Data transfer using PC-DOS 32-bit floating point format .....	24
3C. Data transfer using the network analyzer internal binary format .....	26
3D. Data transfer using markers .....	29
Advanced Programming Examples: .....	33
Using list frequency mode: .....	33
4A. List frequency sweep .....	33
4B. Single segment selection .....	37
Using limit lines: .....	40
5A. Limit line set-up .....	40
5B. PASS/FAIL tests .....	45
Storing/recalling instrument states: .....	47
6A. Learn string .....	47
6B. Reading calibration data .....	49
Miscellaneous Programming Examples: .....	53
7. Interrupt generation .....	53
8. User interface .....	56
Appendix A: Status Reporting .....	63
A1. Error queue .....	63
A2. Status registers .....	66

## Equipment

To run the examples in this Programming Guide, the following equipment is required:

- HP 8752A or 8753C Network Analyzer.
- HP Vectra Personal Computer (or compatible) with Microsoft QuickBASIC 4.5, HP 82335A HP-IB Interface Card, MS-DOS® 3.2 or higher, and at least 320 Kbytes of memory.
- HP 10833A/B/C/D HP-IB cables to interconnect the computer, the network analyzer, and any peripherals.

The following equipment is optional:

- HP 85032B 50 ohm type-N calibration kit.
- HP 11857D 7 mm test port return cables (HP 8753C only).
- A test device such as a filter to use in the example measurement programs.

MS-DOS® is a U.S. registered trademark of Microsoft Corp.

## Preparation

1. **System.** Connect the network analyzer to the computer with an HP-IB cable. The network analyzer has only one HP-IB interface, but it occupies two addresses: one for the instrument and one for the display. The display address is the instrument address with the least significant bit complemented. The default addresses are 16 for the instrument and 17 for the display. Other devices on the bus cannot occupy the same address as the network analyzer.
2. **Computer.** Turn on the computer and load QuickBASIC by typing `QB /L QBHP IB` at the MS-DOS prompt. Invoking QuickBASIC in this way will load the Quick library `QBHP IB.QLB`, making its contents available for use.
3. **Network analyzer.** Turn on the network analyzer and verify its address by pressing `[LOCAL][SET ADDRESSES]` and `[ADDRESS: 875x]`. If the address has been changed from the default value (16), return it to 16 to perform the examples in this document by pressing `[1][6][x1][PRESET]`. Make sure the instrument is in `[TALKER/LISTENER]` mode, as indicated under the `[LOCAL]` key, since this is the only mode in which the network analyzer and an HP Vectra can communicate over HP-IB.
4. **Connection.** Type the following on the computer in the immediate portion of the display and all on one line:

```
CALL IOOUTPUTS(716&, "PRES;",  
LEN("PRES;")): IF PCIB.ERR <> NOERR THEN  
ERROR PCIB.BASERR
```

This presets the network analyzer. If a preset does not occur, there is a problem. Since many HP-IB problems are caused by an incorrect address or bad or loose HP-IB cables, check all HP-IB addresses and connections.

## Notes on QuickBASIC

In QuickBASIC, multiple statements are allowed per line, and line numbers are not required. In the examples in this programming guide, line numbers are included for clarity. Each line is preceded by a line number, and each line number is followed by a complete one-line statement. No carriage returns are used in the statements although it may appear that way on the following pages. The following error trapping line should follow every call to an I/O routine:

```
IF PCIB.ERR <> NOERR THEN ERROR PCIB.BASERR
```

In the following example programs, this line is generally made into a separate routine that can easily be executed after every call to an I/O routine:

```
CALL IOXXXX: GOSUB ERRORTRAP
```

If an error occurs, the number corresponding to that error is assigned to the variable `PCIB.ERR` and the program branches to an HP-IB Command Library subprogram for error handling which displays a message on the computer screen stating the error number and type.



Since the IOOUTPUTS command library routine to send a command from the computer to the analyzer is called so often and is so long, it is worthwhile to make it into a separate routine (called IOOUTS here) that can be executed with a GOSUB statement. If this is done, the line to preset the analyzer becomes

```
A$ = "PRES;": GOSUB IOOUTS
```

and the program END is followed by the ERRORTRAP and IOOUTS routines.

```
:
END

ERRORTRAP:
  IF PCIB.ERR <> NOERR THEN ERROR PCIB.BASERR
  RETURN

IOOUTS:
  CALL IOOUTPUTS(716&, A$, LEN(A$)): GOSUB
  ERRORTRAP
  RETURN
```

The construction of the IOOUTPUTS call is as follows:

```
CALL IOOUTPUTS(716&, A$, LEN(A$)): GOSUB
ERRORTRAP
```

CALL IOOUTPUTS: command. Execute the HP-IB string data output command.

716&: address. The data is directed to interface 7 (HP-IB) and out to the device at address 16 (the network analyzer). The appended "&" is required by the IO routine, which expects a long-integer.

A\$: HP-IB command string. A\$ should be set equal to the mnemonic corresponding to the desired operation before the GOSUB IOOUTS command that will execute the call to IOOUTPUTS is given.

LEN(A\$): length. The IOOUTPUTS routine must know the length (in characters) of the command string it is sending so that it can append an appropriate line terminator.

GOSUB ERRORTRAP: error trap. The call to an error trapping routine that must follow every call to an I/O routine.

Just as there are I/O commands to send data to the analyzer, there are I/O commands to receive data from the analyzer. For more information on this topic, see the section entitled *Transferring Data*.

## Basic Instrument Control

### Preparation for HP-IB control

At the beginning of a program, the network analyzer has to be taken from an unknown state and brought under computer control. One way to do this is with an abort/clear sequence, which prepares the bus for activity and the analyzer for receiving HP-IB commands. In addition, a time-out should be set (IOTIMEOUT), and, if the program will be

transferring data, the end-or-identify mode should be disabled (IOEOI). Because a known initial instrument state makes programs more reliable, the next step is generally to put the network analyzer into a known state. The most convenient way to do this is to send PRES, which returns the analyzer to the preset state. If preset is not desired and the status reporting mechanism is going to be used, CLES can be sent to clear all of the status reporting registers and their enabled bits.

For an example of the necessary preparation for HP-IB control in QuickBASIC programs, load the following program (stored on the Example Programs disk as IPGILBAS). Note that the first four I/O commands are to the address 7&, the interface bus. Only the IOOUTPUTS command is actually to the analyzer, address 716&.

```
10 CALL IOTIMEOUT(7&, 10!): GOSUB ERRORTRAP
```

Define a system time-out of 10 seconds. (This value is chosen because most sweeps and calibration calculations are completed in under 10 seconds.) Time-out allows recovery from I/O operations that are not completed in the allowed number of seconds.

```
20 CALL IOABORT(7&): GOSUB ERRORTRAP
```

Halt any bus activity and return active control to the computer.

```
30 CALL IOCLEAR(7&): GOSUB ERRORTRAP
```

Clear syntax errors, the input command buffer, and any messages waiting to be sent out. This command does not affect the status reporting system.

```
40 CALL IOEOI(7&, 0): GOSUB ERRORTRAP
```

Disable the end-or-identify mode for transferring data. This prevents both a write operation from setting the EOI line on the last byte of the write and a read operation from terminating upon sensing that the EOI line has been set.

```
50 A$ = "PRES;": GOSUB IOOUTS
```

Send the HP-IB mnemonic PRES to the network analyzer (address = 716) via the IOOUTS subroutine. This presets the instrument, clears the status reporting system, and resets all front panel settings except the HP-IB mode and the HP-IB addresses.

```
60 END
```

End program execution.

```
70 ERRORTRAP:
80 IF PCIB.ERR <> NOERR THEN ERROR
  PCIB.BASERR
90 RETURN
100 IOOUTS:
110 CALL IOOUTPUTS(716&, A$, LEN(A$)):
  GOSUB ERRORTRAP
120 RETURN
```

This program brings the network analyzer to a known state and prepares it to respond to HP-IB control. The network analyzer will not respond to HP-IB commands unless the remote line is asserted. When the remote line is asserted and the analyzer is addressed to listen, it automatically goes into remote mode. Remote mode means that all front panel keys except [LOCAL] and the line power switch are disabled. The command IOABORT asserts the remote line, which remains asserted until the command IOLOCAL is executed. Another way to assert the remote line is to execute

```
CALL IOREMOTE(716&): GOSUB ERRORTRAP
```

This statement asserts the remote line and addresses the network analyzer to listen, thereby putting it into remote mode. Now no front panel key will respond until [LOCAL] is pressed.

The local key can also be disabled with the following sequence:

```
CALL IOREMOTE(716&): GOSUB ERRORTRAP  
CALL IOLOCKOUT(7&): GOSUB ERRORTRAP
```

Now no front panel key (including [LOCAL]) except the line power switch will respond. The analyzer can be returned to local mode temporarily with the following command:

```
CALL IOLOCAL(716&): GOSUB ERRORTRAP
```

However, as soon as the analyzer is next addressed to listen, it goes back into local lockout. The only way to clear local lockout, other than cycling power, is to execute

```
CALL IOLOCAL(7&): GOSUB ERRORTRAP
```

This disables the remote line on the interface, puts the instrument into local mode, and clears local lockout.

## Commands

A computer controls the network analyzer by sending it commands over HP-IB. Each command is specific to the network analyzer and is executed automatically, taking precedence over analyzer manual control. A command applies only to the active channel unless functions are coupled between channels, just as with front panel operation. Most commands are equivalent to front panel functions.

### No operand commands

The simplest command that the network analyzer accepts is one that requires no operand. For example, AUTO is a no operand command. Leave the previous program in the main window and put the cursor in the immediate window. Now execute

```
A$ = "AUTO;": GOSUB IOOOTS
```

In response, the network analyzer autoscales the active channel just as it would if [SCALE REF] [AUTO SCALE] were pressed on the analyzer's front panel.

The semicolon following AUTO terminates the command inside the network analyzer. It clears the active entry area and prepares the network analyzer for the next command. If there is a syntax error in a command, the network analyzer will ignore the command and look for the terminating semicolon. When it finds this terminator, the network analyzer starts processing incoming commands normally. Characters between the syntax error and the next terminator are lost. A line feed can also act as terminator. The QuickBASIC IOOOUTPUTS routine, which is called from the user-defined subprogram IOOOTS, automatically transmits a carriage return/line feed following the data if there is not a semicolon at the end of the statement.

The IOOOUTPUTS routine will transmit all commands listed, as long as they are separated by commas or semicolons. All the information enclosed in quotes will be transmitted literally. A carriage return/line feed is transmitted after each command, but this can be prevented by separating commands with semicolons instead of commas.

The network analyzer does not distinguish between upper and lower case letters. For example, execute

```
A$ = "auto;": GOSUB IOOOTS
```

### On/off commands

The network analyzer also accepts a command that turns a function on and off. Execute

```
A$ = "DUACON;": GOSUB IOOOTS
```

This activates dual channel display mode on the network analyzer. To restore single channel display mode, execute

```
A$ = "DUACOFF;": GOSUB IOOOTS
```

The command is composed of the root mnemonic DUAC (dual channel) and ON or OFF.

In addition, the network analyzer has a debug mode to aid in troubleshooting systems. When debug mode is on, the network analyzer scrolls incoming HP-IB commands across the display. To turn this mode on manually, press [LOCAL] [HP-IB DIAG ON]. To turn it on over HP-IB, execute

```
A$ = "DEBUON;": GOSUB IOOOTS
```

## Parameter setting commands

The analyzer also accepts commands that set parameters. For example, execute

```
A$ = "STAR 10 MHZ;": GOSUB IOOUTS
```

The network analyzer now has a start frequency of 10 MHz. The STAR 10 MHZ command performs the same function as keying in [START] [1] [0] [M/u] from the network analyzer's front panel. STAR is the root mnemonic for the start key, 10 is the data, and MHZ is the units. The network analyzer's root mnemonics are derived from the equivalent key label if possible and from the common name for the function if not. The *HP-IB Quick Reference* lists all the root mnemonics and all the different units accepted.

Notice that the front panel remote (R) and listen (L) HP-IB status indicators are on. The network analyzer automatically goes into remote mode when it is sent a command with the IOOUTPUTS statement.

## Interrogate instrument state commands

Each instrument parameter can be interrogated to find its current state or value with query commands. If a question mark is appended to the root mnemonic of a command, the network analyzer will send out the value of that parameter. For example, the command POWE 5 DB sets the analyzer's output power to +5 dBm, and the command POWE? tells the analyzer to send out the current RF output power value at the test port to the computer. The program in the main window can be modified to show the use of this command by deleting line 50 and inserting the following lines before the END at line 60.

```
45 A$ = "POWE?": GOSUB IOOUTS
50 CALL IOENTER(716&, REPLY!): GOSUB
  ERRORTRAP
55 PRINT REPLY!
```

This modified program is stored on the Example Programs disk as IPGI2.BAS.

Now run the program, and the computer will display the source power level in dBm. The preset level is 0 dBm for the 8753C and -10 dBm for the 8752A. Next change the power level by pressing [LOCAL] [MENU] [POWER] [1] [x1], and run the program again.

When the network analyzer receives the command POWE?, it prepares to send out the current RF source power level. The QuickBASIC statement CALL IOENTER(716&, REPLY!): GOSUB ERRORTRAP addresses the analyzer to talk, thereby allowing it to transmit information to the computer. This turns the network analyzer front panel talk light (T) on. The computer places the data transmitted by the network analyzer into the variable listed in the IOENTER statement. In this case, the network analyzer transmits the output power value, and this gets placed in the real number variable REPLY!.

The IOENTER statement takes the binary data sent out from the network analyzer and formats it into a real number. There are other I/O routines for entering a string (IOENTERS), an array of real numbers (IOENTERA), and unformatted data (IOENTERAB, IOENTERB). The data being requested is determined by the I/O routine and must correspond to the variable being received.

On/off commands can also be interrogated. The reply is 1 if the function is on and 0 if it is off. Similarly, if a command controls a function that is underlined on the network analyzer display when active, interrogating that command yields 1 if the command is underlined and 0 if it is not. For example, there are nine options in the format menu, and only one is underlined at a time. Of the nine, only the underlined option will return 1 when interrogated.

For instance, rewrite line 45 as

```
45 A$ = "DUAC?": GOSUB IOOUTS
```

Run the program once and note the result. Then press [LOCAL] [DISPLAY] [DUAL CHAN] to toggle the display mode, and run the program again to observe the difference.

Another example is to rewrite line 45 as

```
45 A$ = "PHAS?": GOSUB IOOUTS
```

In this case, the computer will display 1, only if phase is currently being displayed on the network analyzer. Since the command only applies to the active channel, the response to the PHAS? inquiry depends on which channel is active.

## Held commands

A held command is one that cannot be interrupted during its execution. When the network analyzer is executing a held command, it holds off processing new HP-IB commands, halting HP-IB operation until the held command completes execution. Some examples of held commands are DONE, PRES, and SING.

While a held command is executing, the network analyzer will still service the HP-IB interface routines, such as IOS POLL, IO CLEAR, and IO ABORT, all of which must be called and followed by error trapping. Executing a call to IO CLEAR will abort a held command, leaving its execution to be completed as if it had been begun from the front panel. These routines (IOS POLL, IO CLEAR, and IO ABORT) also clear the input buffer, destroying any commands received after the held command. If the network analyzer has halted the bus because its input buffer was full, executing a call to the routine IO ABORT will release the bus.

## Operation complete (OPC)

The operation complete (OPC) function allows synchronization of the program by requiring the current command to complete execution before the next command can begin. For instance, a program should not have the operator connect the next calibration standard while the network analyzer is still measuring the current one. To provide OPC information, the network analyzer uses its OPC reporting mechanism, which indicates when the execution of certain key commands has been completed. The function is activated by sending either `OPC` or `OPC?` immediately before an OPC'able command. When the command completes execution, bit 0 of the Event Status Register is set. If `OPC?` is interrogated, the network analyzer outputs 1 when the command completes execution.

The program in the main window can be modified to show the use of the `OPC?` command by deleting lines 45 through 55 and inserting the following lines before the `END` at line 60.

```
44 A$ = "SWET 3 S; OPC?; SING;": GOSUB
    IOOUTS
```

Set the sweep time to 3 seconds, and `OPC?` a single sweep.

```
48 PRINT "SWEEPING"
52 CALL IOENTER(716&,REPLY!): GOSUB
    ERRORTRAP
```

The program will halt until the network analyzer completes the sweep and sends out 1.

```
56 PRINT "DONE"
```

The modified program is stored on the Example Programs disk as `IPGI3.BAS`.

When it is run, the computer displays the sweeping message as the analyzer executes the sweep, and the computer displays `DONE` when the analyzer finishes the sweep. When `DONE` appears, the program can continue with a valid data trace ensured in the analyzer. Without a single sweep, it takes more than one sweep time to ensure good data.

## Measurement Programming

The previous section of this document outlined the process to get commands into the network analyzer. The next step is to organize the commands into a measurement sequence. A typical measurement sequence consists of the following steps:

1. Prepare the instrument.
2. Calibrate the instrument.
3. Connect the device under test.
4. Make the measurement.
5. Process the data.
6. Transfer the data.

## Prepare the instrument

Define the measurement by setting the basic measurement parameters. These include all the stimulus parameters (sweep type, span, sweep time, number of points, and RF power level) as well as the parameter to be measured, IF averaging, and IF bandwidth. These parameters define how data is gathered and processed within the instrument. Changing any parameter requires that a new sweep be taken.

Other parameters can be set within the instrument, such as smoothing, trace scaling, or trace math, that do not directly affect data gathering. These functions are classified as post processing functions: they can be changed with the instrument in hold mode, and the data will correctly reflect the new state.

The save/recall registers and the learn string are two rapid ways of setting up an entire instrument state. The learn string is a string summary of the instrument state that can be read into and sent out from the computer, as shown in Example 6A: *Using the learn string*.

## Calibrate the instrument

Measurement calibration is normally performed once the instrument state has been defined. Although it is not required to make a measurement, calibration improves the accuracy of the data.

There are several ways to calibrate the instrument. The simplest way is to stop the program and have the operator perform the calibration from the front panel. Alternatively, the computer can be used to guide the operator through the calibration, as shown in Examples 2A: *1-port calibration* and 2B: *Full 2-port calibration (HP 8753C only)*. Lastly, calibration data saved from a previous calibration can be transmitted back into the instrument, as shown in Example 6B: *Reading calibration data*. This should only be done if the hardware configuration has not changed.

## Connect the device under test

The computer can be used to verify that the device is connected properly and to speed up the adjustment process. Useful functions for this purpose include limit testing, bandwidth searches, and trace statistics. All device adjustments should take place at this stage and be finished before taking data.

## Make the measurement

Once the device is connected and adjusted, measure its frequency response and hold the data within the instrument so that there is a valid trace to analyze. The single sweep command `SING` is designed to do this. All stimulus changes are completed before the sweep is started, and the HP-IB hold state is not released until the formatted trace is displayed. When the sweep is complete, the instrument is put into hold mode, which freezes the data inside the instrument. Because single sweep is OPC'able, it is easy to determine when the sweep has been completed.

The number of groups command NUMGn is similar to SING, but it triggers n sweeps. This is useful, for example, in making a measurement with an averaging factor n (n can range from 1 to 999). Both SING and NUMGn commands restart averaging.

### Process the data

With valid data to operate on, the post-processing functions can be used. Referring ahead to the data processing chain in Figure 1 (page 20), notice that any function that affects the data after the error correction stage can be used. The most useful functions are trace statistics, marker searches, electrical delay offset, time domain, and gating. If a 2-port calibration is active, then any of the four S-parameters can be viewed without taking a new sweep.

### Transfer the data

Lastly, transmit the results out of the instrument. Each data output command is designed to ensure that transmitted data reflects the current state of the instrument.

- The commands OUTPDATA, OUTPRAWn, and OUTPFORM will transmit data only after all formatting functions have completed.

- The commands OUTPLIML, OUTPLIMM, and OUTPLIMF will transmit data only after a limit test has occurred (if limit testing is on).
- The command OUTPMARK will activate a marker (if one is not already selected) and will transmit data only after any current marker searches have completed.
- The command OUTPMSTA will transmit data only after marker statistics for the current trace have been calculated. If the statistics function is not on, it will be turned on to update the current values and then turned off.
- The command OUTPMWID will transmit data only after a bandwidth search has been executed for the current trace. If the bandwidth search function is not on, it will be turned on to update the current values and then turned off.

Data transfer is discussed further in Examples 3A through 3D: *Transferring data*.

# Basic Programming Examples

## Making measurements

The procedure for setting up measurements on the network analyzer via HP-IB follows the same sequence as when the setup is performed manually. As long as the desired frequency range, number of points, and power level are set prior to performing the calibration, there is no required order.

### Example 1: Setting up a basic measurement

The following program illustrates how to set up a basic measurement on the network analyzer. The program will select the desired parameter, measurement format, and frequency range. Performing calibrations is described in later examples.

This example program is stored on the Example Programs disk as **IPG1.BAS**.

10	REM \$INCLUDE: 'QBSETUP'	Call the QuickBASIC initialization file QBSETUP, the setup program for the MS-DOS HP-IB Command Library. This command should appear before the body of the program whenever calls to the HP-IB Command Library are to be made.
20	CLS	Clear the computer CRT.
30	ISC& = 7	Assign the interface select code to a variable. This select code is set on the HP 82335A HP-IB interface card.
40	VNA& = 716	Assign the address of the HP 8753C/8752A to a variable.
50	CALL IOTIMEOUT(ISC&, 10!): GOSUB ERRORTRAP	Define a system time-out of 10 seconds and perform error trapping. Time-out allows recovery from I/O operations that are not completed in under 10 seconds.
60	CALL IOABORT(ISC&): GOSUB ERRORTRAP	Abort any HP-IB transfers and perform error trapping.
70	CALL IOCLEAR(ISC&): GOSUB ERRORTRAP	Clear the analyzer's HP-IB interface and perform error trapping.
80	CALL IOEOI(ISC&, 0): GOSUB ERRORTRAP	Disable the End-Or-Identify mode for transferring data and perform error trapping.
90	A\$ = "PRES; MENUOFF;": GOSUB IOOOTS	Preset the network analyzer and turn its softkey menu off.
100	A\$ = "CHAN1; S21; LOGM;": GOSUB IOOOTS	Make channel 1 the active channel and measure the forward transmission parameter, displaying its magnitude in decibels. The mnemonic for this parameter is the same for both analyzers (S21) although it is called TRANSMISSION on the HP 8752A.
110	A\$ = "CHAN2; S21; PHAS;": GOSUB IOOOTS	Make channel 2 the active channel and measure the phase of the forward transmission parameter.
120	A\$ = "DUACON;": GOSUB IOOOTS	Display both channels simultaneously.
130	LOCATE 1, 1: INPUT "ENTER START FREQUENCY (MHz): ", F.START!	Position the cursor on the computer CRT at (row,column) = (1,1), and read in a real start frequency, F.START!.
140	LOCATE 1, 41: INPUT "ENTER STOP FREQUENCY (MHz): ", F.STOP!	Read in a real stop frequency, F.STOP!.

150 A\$ = "STAR" + STR\$(F.START!) + "MHz;": GOSUB IOOOTS	Set the start frequency on the network analyzer to F.START!. In QuickBASIC, the "+" is used to concatenate strings.
160 A\$ = "STOP" + STR\$(F.STOP!) + "MHz;": GOSUB IOOOTS	Set the stop frequency on the network analyzer to F.STOP!.
170 A\$ = "AUTO;": GOSUB IOOOTS	Autoscale the network analyzer's active channel (2).
180 A\$ = "CHAN1; AUTO;": GOSUB IOOOTS	Activate and autoscale channel 1.
190 A\$ = "MENUON;": GOSUB IOOOTS	Turn the network analyzer's softkey menu back on.
200 CALL IOLOCAL(ISC&): GOSUB ERRORTRAP	Return the network analyzer to local mode and perform error trapping.
210 END	End program execution.
220 ERRORTRAP:	Define a routine to trap errors.
230 IF PCIB.ERR <> NOERR THEN ERROR PCIB.BASERR	Perform error trapping.
240 RETURN	Return from the ERRORTRAP routine.
250 IOOOTS:	Define a routine to send a command string from the computer to the analyzer.
260 CALL IOOUTPUTS(VNA&, A\$, LEN(A\$)): GOSUB ERRORTRAP	Send the command string A\$ out to the analyzer and perform error trapping.
270 RETURN	Return from the IOOOTS routine.

### Running the program

1. The computer sets up a measurement of transmission log magnitude on channel 1 and transmission phase on channel 2, displaying both measurements simultaneously by using the dual channel display mode.
2. Enter any valid value in MHz when prompted for start and stop frequencies.
3. The computer will enter the specified start and stop frequencies into the network analyzer, and they will be the frequency limits of the analyzer's display.

## Performing calibrations

Coordinating a measurement calibration over HP-IB follows the keystrokes required to calibrate from the front panel in that there is a command for every step. The general key sequence is to select the calibration, to measure the calibration standards, and then to declare the calibration done. The actual sequence depends on the calibration kit and changes slightly for 2-port calibrations\*, which are divided into three calibration sub-sequences.

The calibration kit tells the network analyzer which standards to expect at each step of the calibration. The set of standards associated with a given calibration is termed a class. For example, measuring the short during a 1-port calibration is one calibration step. All of the shorts that can be used for this calibration step make up the class, which is called class S11B. For the 7 mm and the 3.5 mm cal kits, class S11B has only one standard, so selecting *[SHORT]* automatically measures the short. For type-N cal kits, however, class S11B has two standards: male and female test ports. Selecting *[SHORTS]* brings up a second menu, allowing the operator to select which standard in the class is to be measured. The sex listed refers to the test port.

To do a 1-port calibration over HP-IB using the 7 mm or 3.5 mm cal kits, sending the command **CLASS11B** will automatically measure the short. For the type-N cal kit, sending **CLASS11B** brings up the menu with the male and female test port options. To select one of these standards, use either the command **STANA** or the command **STANB**. The **STAN** command can be appended with the letters **A** through **G**, corresponding to the standards listed under softkeys 1 through 7, softkey 1 being the uppermost softkey. The **STAN** command is always OPC'able, but a **CLASS** command is OPC'able only if the class has just one standard in it, which is then automatically measured. This is because when there is more than one standard in a class, the command that calls the class simply brings up another menu.

Each full 2-port measurement calibration is divided into three subsequences: transmission, reflection and isolation. Each subsequence is treated like a calibration in its own right: each must be opened, all of its standards must be measured, and then it must be declared done. The opening and closing commands for the subsequences are similar.

Transmission subsequence: **TRAN** and **TRAD**

Reflection subsequence: **REFL** and **REFD**

Isolation subsequence: **ISOL** and **ISOD**

\*HP 8753C only.



## Example 2A: 1-port calibration

The following program illustrates how to perform a 1-port measurement calibration on the network analyzer over HP-IB. The program does the calibration using the HP 85032B 50 ohm type-N calibration kit. It steps the operator through the calibration by giving explicit directions on the network analyzer display and allowing the user to continue the program from the network analyzer front panel. The desired instrument state should be set up before the program is run.

This example program is stored on the Example Programs disk as **IPG2A.BAS**.

10	DECLARE SUB ERRORTRAP ( )	Define a subroutine to trap errors.
20	DECLARE SUB IOOUTS (A\$, ADDRESS&)	Define a subroutine to send a command string from the computer to the analyzer.
30	DECLARE SUB WAITFORKEY (LABEL\$, VNA&, DISPLAY&, ISC&)	Define a subroutine to display a message on the analyzer and wait for the operator to press a key.
40	REM \$INCLUDE: 'QBSETUP'	Call the QuickBASIC initialization file QBSETUP.
50	CLS	Clear the computer CRT.
60	ISC& = 7	Assign the interface select code to a variable.
70	VNA& = 716	Assign the analyzer's address to a variable.
80	DISPLAY& = 717	Assign the analyzer's display address to a variable.
90	CALL IOTIMEOUT(ISC&, 10!): CALL ERRORTRAP	Define a system time-out of ten seconds and perform error trapping.
100	CALL IOABORT(ISC&): CALL ERRORTRAP	Abort any HP-IB transfers and perform error trapping.
110	CALL IOCLEAR(ISC&): CALL ERRORTRAP	Clear the analyzer's HP-IB interface and perform error trapping.
120	CALL IOEDI(ISC&, 0): CALL ERRORTRAP	Disable the End-Or-Identify mode for transferring data and perform error trapping.
130	CALL IOOUTS("CALKN50; MENUOFF; CLES; ESE64;", VNA&)	Select the 50 ohm type-N cal kit, turn off the softkey menu, clear the status byte, and set up the status reporting system so that bit 6, User Request, of the Event Status Register is summarized by bit 5 of the status byte, allowing a key press to be detected by a serial poll. For more information about setting up status reporting systems, refer to <i>Example 7: Interrupt generation</i> .
140	CALL IOOUTS("WAIT;", VNA&)	Wait for a clean sweep on the analyzer so that the following command will have the proper effect.
150	CALL IOOUTS("ENTO;", VNA&)	Clear the analyzer's entry area.
160	CALL IOOUTS("CALIS111;", VNA&)	Open the calibration by calling the S11 1-port calibration.
170	CALL WAITFORKEY("CONNECT OPEN AT PORT 1", VNA&, DISPLAY&, ISC&)	Ask for an open and wait for the operator to connect it.
180	CALL IOOUTS("CLASS11A; OPC?; STANB;", VNA&)	Measure the open. Identify the specific standard (female test port) within the class using the command STANB, indicating the option at the second softkey from the top.
190	CALL IOENTER(VNA&, REPLY!): CALL ERRORTRAP	Wait for the standard to be measured.

200 CALL WAITFORKEY("CONNECT SHORT AT PORT 1", VNA&, DISPLAY&, ISC&)	Ask for a short and wait for the operator to connect it.
210 CALL IOOUTS("CLASS11B; OPC?; STANB;", VNA&)	Measure the short. Identify the specific standard (female test port) within the class.
220 CALL IOENTER(VNA&, REPLY!): CALL ERRORTRAP	Wait for the standard to be measured.
230 CALL WAITFORKEY("CONNECT LOAD AT PORT 1", VNA&, DISPLAY&, ISC&)	Ask for a load and wait for the operator to connect it.
240 CALL IOOUTS("OPC?; CLASS11C;", VNA&)	Measure the load. There are no options within this class, so OPC?, which always precedes the last command, comes first.
250 CALL IOENTER(VNA&, REPLY!): CALL ERRORTRAP	Wait for the standard to be measured.
260 CALL IOOUTS("PG;", DISPLAY&)	Clear the user graphics by removing the last prompt.
270 CLS : PRINT "COMPUTING CALIBRATION COEFFICIENTS"	Display program progress on the computer CRT.
280 CALL IOOUTS("DONE; OPC?; SAV1;", VNA&)	Complete the calibration and save it.
290 CALL IOENTER(VNA&, REPLY!): CALL ERRORTRAP	Wait until the network analyzer has computed the calibration coefficients before continuing.
300 CLS : PRINT "1-PORT CALIBRATION COMPLETED. CONNECT TEST DEVICE."	Display program progress and instructions on the computer CRT.
310 CALL IOOUTS("MENUON;", VNA&)	Turn the softkey menu back on.
320 CALL IOLOCAL(ISC&): CALL ERRORTRAP	Return the analyzer to local mode and perform error trapping.
330 END	End program execution.
340 SUB ERRORTRAP	Define a subroutine to trap errors.
350 IF PCIB.ERR <> NOERR THEN ERROR PCIB.BASERR	Perform error trapping.
360 END SUB	Return from the ERRORTRAP subroutine.
370 SUB IOOUTS (A\$, ADDRESS&) STATIC	Define a subroutine to send a command string from the computer to the analyzer.
380 CALL IOOUTPUTS(ADDRESS&, A\$, LEN(A\$)): CALL ERRORTRAP	Send the command string A\$ out to the analyzer and perform error trapping.
390 END SUB	Return from the IOOUTS subroutine.
400 SUB WAITFORKEY (LABEL\$, VNA&, DISPLAY&, ISC&) STATIC	Define a subroutine to display a message on the analyzer and wait for the operator to press a key.
410 CLS : PRINT LABEL\$	Display instructions on the computer CRT.

<pre> 420 CALL IOOUTS("PG; PU; PA 390,3600; PD; LB" + LABEL\$ + "; PRESS ANY KEY WHEN READY." + CHR\$(3), DISPLAY&amp;) </pre>	<p>Write on the network analyzer's display:  PG : PaGe; clears old user graphics.  PU : Pen Up; prevents anything from being drawn.  PA : Pen At; positions the logical pen.  PD : Pen Down; enables drawing.  LB : LaBel; writes the message on the display. The label must always be terminated by the ETX symbol, CHR\$(3).</p>
<pre> 430 CALL IOOUTS("ESR?;", VNA&amp;) </pre>	<p>Request the Event Status Register value from the analyzer.</p>
<pre> 440 CALL IOENTER(VNA&amp;, ESTAT!): CALL ERRORTRAP </pre>	<p>Receive the Event Status Register value from the analyzer, thereby clearing the latched User Request bit so that old key presses will not trigger a measurement.</p>
<pre> 450 CALL IOOUTS("ESE64;", VNA&amp;) </pre>	<p>Ensure that the proper status reporting system is still in effect.</p>
<pre> 460 STAT% = 0 </pre>	<p>Initialize STAT% for entry into the DO UNTIL loop.</p>
<pre> 470 DO UNTIL ((STAT% MOD 64) &gt;31) </pre>	<p>Wait for a key press to be indicated by the setting of bit 5 of the status byte. MOD 64 removes the effect of all higher value bits (bit 6 is equivalent to 64 in decimal), and &gt;31 ensures that bit 5, which is equivalent to 32 in decimal, is set.</p>
<pre> 480 CALL IO\$POLL(VNA&amp;, STAT%): CALL ERRORTRAP </pre>	<p>Read in the status byte as an integer.</p>
<pre> 490 LOOP </pre>	
<pre> 500 END SUB </pre>	<p>Return from the WAITFORKEY subroutine.</p>

### Running the program

1. The computer assumes that the port being calibrated is a 50 ohm type-N female test port and prompts the operator to connect each standard.
2. Connect the standards as prompted, and press any key on the front panel of the network analyzer to continue the program and measure the standard.
3. The program will display a message when the measurement calibration is complete.

## Example 2B: Full 2-port calibration (HP 8753C only)

The following program illustrates how to perform a full 2-port measurement calibration on the network analyzer over HP-IB. The program does the calibration using the HP 85032B calibration kit. It steps the operator through the calibration by giving explicit directions on the network analyzer display and allowing the user to continue the program from the network analyzer front panel. The desired instrument state should be set up before the program is run. The main difference between this example and Example 2A is that in this case the calibration process allows removal of both the forward and reverse error terms. This permits measurement of all four S-parameters of the device under test. Port 1 is a female test port and port 2 is a male test port.

This example program is stored on the Example Programs disk as **IPG2B.BAS**.

10	DECLARE SUB ERRORTRAP ( )	Define a subroutine to trap errors.
20	DECLARE SUB IOOUTS (A\$, ADDRESS&)	Define a subroutine to send a command string from the computer to the analyzer.
30	DECLARE SUB WAITFORKEY (LABEL\$, VNA&, DISPLAY&, ISC&)	Define a subroutine to display a message on the analyzer and wait for the operator to press a key.
40	REM \$INCLUDE: 'QBSETUP'	Call the QuickBASIC initialization file QBSETUP.
50	CLS	Clear the computer CRT.
60	ISC& = 7	Assign the interface select code to a variable.
70	VNA& = 716	Assign the analyzer's address to a variable.
80	DISPLAY& = 717	Assign the analyzer's display address to a variable.
90	CALL IOTIMEOUT(ISC&, 10!): CALL ERRORTRAP	Define a system time-out of ten seconds and perform error trapping.
100	CALL IOABORT(ISC&): CALL ERRORTRAP	Abort any HP-IB transfers and perform error trapping.
110	CALL IOCLEAR(ISC&): CALL ERRORTRAP	Clear the analyzer's HP-IB interface and perform error trapping.
120	CALL IOEDI(ISC&, 0): CALL ERRORTRAP	Disable the End-Or-Identify mode for transferring data and perform error trapping.
130	CALL IOOUTS("CALKN50; MENUOFF; CLES; ESE64;", VNA&)	Select the 50 ohm type-N cal kit, turn off the soft-key menu, clear the status byte, and set up the status reporting system so that bit 6, User Request, of the Event Status Register is summarized by bit 5 of the status byte, allowing a key press to be detected by a serial poll.
140	CALL IOOUTS("CALIFUL2;", VNA&)	Open the calibration by calling for a full two-port calibration.
150	CALL IOOUTS("REFL;", VNA&)	Open the reflection calibration subsequence.
160	CALL WAITFORKEY("CONNECT OPEN AT PORT 1", VNA&, DISPLAY&, ISC&)	Ask for an open at port 1 and wait for the operator to connect it.
170	CALL IOOUTS("CLASS11A; OPC?; STANB;", VNA&)	Measure the open. Identify the specific standard (female test port) within the class using the command STANB, indicating the option at the second softkey from the top.
180	CALL IOENTER(VNA&, REPLY!): CALL ERRORTRAP	Wait for the standard to be measured.
190	CALL WAITFORKEY("CONNECT SHORT AT PORT 1", VNA&, DISPLAY&, ISC&)	Ask for a short at port 1 and wait for the operator to connect it.

200 CALL IDOUTS("CLASS11B; OPC?; STANB;", VNA&)	Measure the short. Identify the specific standard (female test port) within the class.
210 CALL IDENTER(VNA&, REPLY!): CALL ERRORTRAP	Wait for the standard to be measured.
220 CALL WAITFORKEY("CONNECT LOAD AT PORT 1", VNA&, DISPLAY&, ISC&)	Ask for a load at port 1 and wait for the operator to connect it.
230 CALL IDOUTS("OPC?; CLASS11C;", VNA&)	Measure the load. There are no options within this class, so OPC?, which always precedes the last command, comes first.
240 CALL IDENTER(VNA&, REPLY!): CALL ERRORTRAP	Wait for the standard to be measured.
250 CALL WAITFORKEY("CONNECT OPEN AT PORT 2", VNA&, DISPLAY&, ISC&)	Ask for an open at port 2 and wait for the operator to connect it.
260 CALL IDOUTS("CLASS22A; OPC?; STANA;", VNA&)	Measure the open. Identify the specific standard (male test port) within the class using the command STANA, indicating the option at the first softkey from the top.
270 CALL IDENTER(VNA&, REPLY!): CALL ERRORTRAP	Wait for the standard to be measured.
280 CALL WAITFORKEY("CONNECT SHORT AT PORT 2", VNA&, DISPLAY&, ISC&)	Ask for a short at port 2 and wait for the operator to connect it.
290 CALL IDOUTS("CLASS22B; OPC?; STANA;", VNA&)	Measure the short. Identify the specific standard (male test port) within the class.
300 CALL IDENTER(VNA&, REPLY!): CALL ERRORTRAP	Wait for the standard to be measured.
310 CALL WAITFORKEY("CONNECT LOAD AT PORT 2", VNA&, DISPLAY&, ISC&)	Ask for a load at port 2 and wait for the operator to connect it.
320 CALL IDOUTS("OPC?; CLASS22C;", VNA&)	Measure the load, noting that there are no options within this class.
330 CALL IDENTER(VNA&, REPLY!): CALL ERRORTRAP	Wait for the standard to be measured.
340 CALL IDOUTS("OPC?; REFD;", VNA&)	Close the reflection calibration subsequence.
350 CLS : PRINT "COMPUTING REFLECTION CALIBRATION COEFFICIENTS"	Display program progress on the computer CRT.
360 CALL IDENTER(VNA&, REPLY!): CALL ERRORTRAP	Wait for the analyzer to finish calculating the reflection calibration coefficients before continuing.
370 CALL IDOUTS("TRAN;", VNA&)	Open the transmission calibration subsequence.
380 CLS : PRINT "OPENING TRANSMISSION CALIBRATION SUBSEQUENCE"	Display program progress on the computer CRT.
390 CALL WAITFORKEY("CONNECT THRU (PORT 1 TO PORT 2)", VNA&, DISPLAY&, ISC&)	Ask for a thru and wait for the operator to connect it.
400 CLS : PRINT "MEASURING FORWARD TRANSMISSION"	Display program progress on the computer CRT.

410 CALL IOOUTS("OPC?; FWDT;", VNA&)	Measure forward transmission.
420 CALL IOENTER(VNA&, REPLY!): CALL ERRORTRAP	Wait for the standard to be measured.
430 CALL IOOUTS("OPC?; FWDI;", VNA&)	Measure forward load match.
440 CALL IOENTER(VNA&, REPLY!): CALL ERRORTRAP	Wait for the standard to be measured.
450 CLS : PRINT "MEASURING REVERSE TRANSMISSION"	Display program progress on the computer CRT.
460 CALL IOOUTS("OPC?; REVT;", VNA&)	Measure reverse transmission.
470 CALL IOENTER(VNA&, REPLY!): CALL ERRORTRAP	Wait for the standard to be measured.
480 CALL IOOUTS("OPC?; REVM;", VNA&)	Measure reverse load match.
490 CALL IOENTER(VNA&, REPLY!): CALL ERRORTRAP	Wait for the standard to be measured.
500 CALL IOOUTS("TRAD;", VNA&)	Close the transmission calibration subsequence.
510 CLS : INPUT "SKIP ISOLATION CALIBRATION? (Y/N) ", ANSWER\$	Ask the operator if the isolation part of the calibration is to be skipped.
520 IF ((ANSWER\$ = "Y") OR (ANSWER\$ = "y")) THEN	Skip the isolation part of the calibration.
530 CALL IOOUTS("DMII;", VNA&)	Tell the analyzer to omit the isolation part of the calibration.
540 ELSE	Do the isolation part of the calibration.
550 CALL WAITFORKEY("ISOLATE TEST PORTS", VNA&, DISPLAY&, ISC&)	Ask the operator to isolate the test ports.
560 CALL IOOUTS("ISOL; AVERFACT10; AVERON;", VNA&)	Open the isolation calibration subsequence. Turn averaging on with an averaging factor of ten.
570 CLS : PRINT "MEASURING REVERSE ISOLATION"	Display program progress on the computer CRT.
580 CALL IOOUTS("OPC?; REVI;", VNA&)	Measure reverse isolation.
590 CALL IOENTER(VNA&, REPLY!): CALL ERRORTRAP	Wait for the standard to be measured.
600 CLS : PRINT "MEASURING FORWARD ISOLATION"	Display program progress on the computer CRT.
610 CALL IOOUTS("OPC?; FWDI;", VNA&)	Measure forward isolation.
620 CALL IOENTER(VNA&, REPLY!): CALL ERRORTRAP	Wait for the standard to be measured.
630 END IF	
640 CALL IOOUTS("ISOD; AVEROFF;", VNA&)	Close the isolation calibration subsequence. Turn off averaging.
650 CALL IOOUTS("PG;", DISPLAY&)	Ensure that the user graphics are cleared by removing the last prompt.
660 CLS : PRINT "COMPUTING CALIBRATION COEFFICIENTS"	Display program progress on the computer CRT.

670 CALL IOOUTS("DONE; DPC?; SAV2;", VNA&)	Affirm the completion of the calibration and save it.
680 CALL IOENTER(VNA&, REPLY!): CALL ERRORTRAP	Wait until the network analyzer has computed the calibration coefficients before continuing.
690 CLS : PRINT "FULL 2-PORT CALIBRATION COMPLETED. CONNECT TEST DEVICE.";	Display program progress and instructions on the computer CRT.
700 CALL IOOUTS("MENUON;", VNA&)	Turn the softkey menu back on.
710 CALL IOLOCAL(ISC&): CALL ERRORTRAP	Return the analyzer to local mode and perform error trapping.
720 END	End program execution.
730 SUB ERRORTRAP	Define a subroutine to trap errors.
740 IF PCIB.ERR <> NOERR THEN ERROR PCIB.BASERR	Perform error trapping.
750 END SUB	Return from the ERRORTRAP subroutine.
760 SUB IOOUTS (A\$, ADDRESS&) STATIC	Define a subroutine to send a command string from the computer to the analyzer.
770 CALL IOOUTPUTS(ADDRESS&, A\$, LEN(A\$)): CALL ERRORTRAP	Send the command string A\$ out to the analyzer and perform error trapping.
780 END SUB	Return from the IOOUTS subroutine.
790 SUB WAITFORKEY (LABEL\$, VNA&, DISPLAY&, ISC&) STATIC	Define a subroutine to display a message on the analyzer and wait for the operator to press a key.
800 CLS : PRINT LABEL\$	Display instructions on the computer CRT.
810 CALL IOOUTS("PG; PU; PA 390,3600; PD; LB" + LABEL\$ + "; PRESS ANY KEY WHEN READY." + CHR\$(3), DISPLAY&)	Write on the network analyzer's display: PG : PaGe; clears old user graphics. PU : Pen Up; prevents anything from being drawn. PA : Pen At; positions the logical pen. PD : Pen Down; enables drawing. LB : LaBel; writes the message on the display. The label must always be terminated by the ETX symbol, CHR\$(3).
820 CALL IOOUTS("ENTO;", VNA&)	Clear the analyzer's entry area.
830 CALL IOCLEAR(VNA&): CALL ERRORTRAP	Clear the analyzer's HP-IB interface and perform error trapping.
840 CALL IOOUTS("ESR?;", VNA&)	Request the Event Status Register value from the analyzer.
850 CALL IOENTER(VNA&, ESTAT!): CALL ERRORTRAP	Receive the Event Status Register from the analyzer, thereby clearing the latched User Request bit so that old key presses will not trigger a measurement.
860 CALL IOOUTS("ESE64;", VNA&)	Ensure that the proper status reporting system is still in effect.
870 STAT% = 0	Initialize STAT% for entry into the DO UNTIL loop.
880 DO UNTIL ((STAT% MOD 64) >31)	Wait for a key press to be indicated by the setting of bit 5 of the status byte. MOD 64 removes the effect of all higher value bits (bit 6 is equivalent to 64 in decimal), and >31 ensures that bit 5, which is equivalent to 32 in decimal, is set.

890 CALL IOSPOLL(VNA&, STAT%): Read in the status byte as an integer.  
CALL ERRORTRAP

900 LOOP

910 CALL IOOUTS("PG;",  
DISPLAY&) Clear the user graphics on the analyzer.

920 END SUB Return from the WAITFORKEY subroutine.

### Running the program

1. The computer assumes that the test ports being calibrated are 50 ohm type-N, port 1 being a female test port and port 2 being a male test port. Prompts to connect each standard appear just above the message line on the HP 8753C display.
2. Connect the standards as prompted, and press any key on the front panel of the network analyzer to continue the program and measure the standard. When the option of omitting the isolation calibration is given, press "Y" or "N" on the computer keyboard. If the isolation cal is performed, averaging is automatically employed to ensure a good calibration.
3. The program will display a message when the measurement calibration is complete.



## Transferring data

Trace information can be read out of the analyzer in two ways. First, trace data can be read selectively using markers. This is preferable if only specific information is needed. Secondly, the entire trace can be read out. This is only necessary if all the trace data is needed. The process of transferring data can be divided into the following three steps:

1. Set up the receiving array. Trace data is represented inside the network analyzer as a real/imaginary component pair for each point. The receiving array for marker data must store three values: this real/imaginary component pair as well as a stimulus value. See Table 1 to identify the first two values according to the current display format and marker mode. The receiving array for reading in an entire trace must be two components wide and the number of points long in order to accommodate all of the trace data. Since QuickBASIC stores data by column and therefore fills the first array dimension first, make the first dimension of the receiving array correspond to the number of elements per point (e.g. 2) and the second dimension correspond to the number of points (e.g. 201). In addition, because a four-byte header is sent out before the trace data when reading in an entire trace in all formats except *form 4*, at least one extra real number or two extra integers must be allocated at the beginning of the receiving array in order to maintain data order. Although this four-byte header can be read in as one real number or as two integers, the four bytes are actually meant to be two ASCII characters and one integer. The first two bytes are the ASCII characters "#A" that indicate that a fixed length block transfer follows. The last two bytes form an integer containing the number of bytes in the block to follow.
2. Request the data from the network analyzer. For marker data, this is always done by the command `OUTPMARK`. For an entire trace, the desired data format and level must be specified. The analyzer can transmit data over HP-IB in five different formats, three of which are shown in the following example programs. The level of the data is determined by the `OUTPxxxx` command used. (See Figure 1.) The different data levels are as follows:
  - Raw data is the basic measurement data. It reflects the stimulus parameters, IF averaging, and IF bandwidth, and is read out with the four `OUTPRAWx` commands. Normally, only `OUTPRAW1` is available, and it sends out the current active parameter; however, if a full 2-port measurement calibration is on, all four `OUTPRAWx` commands are available. The four arrays correspond to S11, S21, S12, and S22, respectively, and the data is in real/imaginary component pairs.
  - Error-corrected data is the raw data with error correction applied. This data is read out with the command `OUTPDATA`, which reads active trace data, or the command `OUTPMEMO`, which reads the error corrected trace memory, if available. The data is for the current active parameter and is in real/imaginary component pairs. Neither raw nor error-corrected data reflect such post-processing functions as electrical delay offset, trace math, or time domain gating.
  - Formatted data, read out by the command `OUTPFORM`, is the data being displayed by the analyzer and reflects all post-processing functions. See Table 1 to identify the array values according to the current display format and marker mode.
  - Calibration coefficient data is the error correction arrays resulting from a calibration. Each array corresponds to a specific error term in the error model, and the data is stored as real/imaginary component pairs. The HP-IB Quick Reference details which error coefficients are used for specific calibration types and which arrays those coefficients are to be found in. Not all calibration types use all twelve arrays.

Because formatted data is seen on the analyzer display, it is generally the most useful. However, if post-processing is not necessary, as may be the case with smoothing, error-corrected data is more desirable.

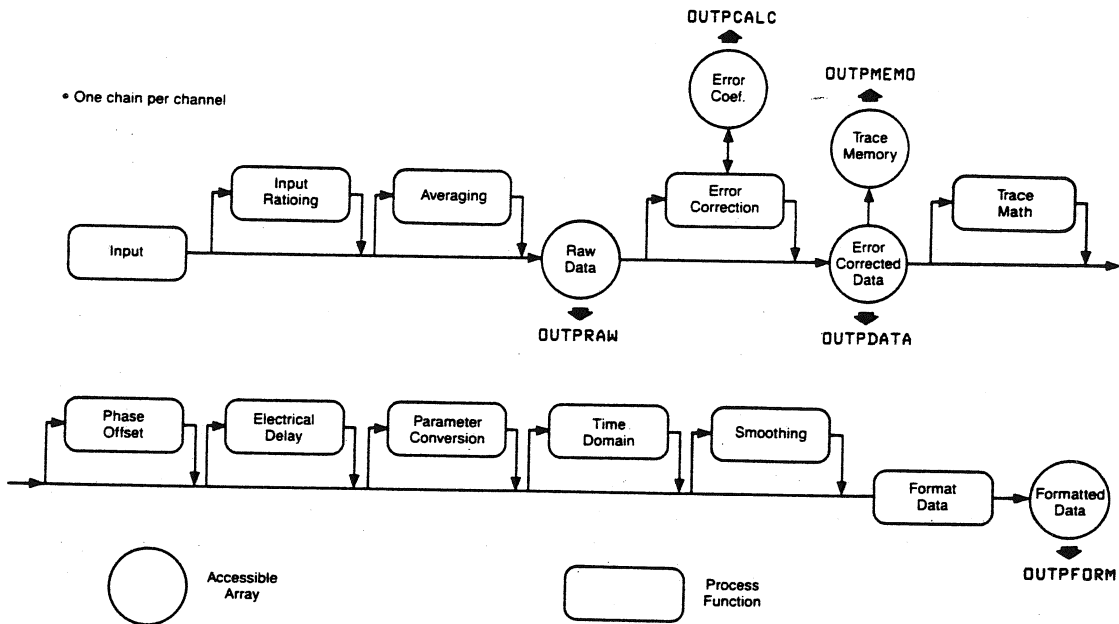

Figure 1. Data processing chain

3. Set all receiving parameters, and receive the data into the array. The receiving parameters and the type of data read in depend on which I/O routine will be used to receive the array. The three parameters in the computer that it may be necessary to initialize are as follows:

- **MAX%:** the maximum number of items to be read. This includes the data and the header for all data formats except *form 4*. See Table 2 to determine whether **MAX%** is to specify a number of real numbers or a number of bytes according to the entering I/O routine used.
- **ACTUAL%:** the actual number of items read. This is set by the I/O routine and should be initialized to zero.
- **FLAG%:** the code set to indicate how transferred bytes are to be placed into memory. For example, **FLAG% = 1** means that bytes will be put into consecutive memory locations; **FLAG% = 4** means that every four bytes will be reversed in memory. See Table 2 to identify the entering I/O routines that use **FLAG%** as a parameter.

In general, the entering I/O routine must be sent a segment address indicating the place in memory to start storing data. If there is a four-byte header to be read in, this address should be one real number or two integers (four bytes) before the desired destination of the true data. For example, an array to hold the data for a 201-point trace with two real numbers per point might be allocated as `DAT!(1 TO 2, 1 TO 201)`. In order to account for the header, it should instead be dimensioned as `DAT!(1 TO 2, 0 TO 201)`, which will add two real numbers to the beginning of the array. Since only one of these is needed to store the four-byte header, the starting address specified in the entering I/O routine should only include one of them in the array: `SEG DAT!(2, 0)`. The result of this is that `DAT!(1, 0)` will be empty, `DAT!(2, 0)` will store the header, and `DAT!(1, 1)` will store the first real number of the data. See Table 2 for a summary of all entering I/O routines. For more information, refer to the *HP-IB Command Library Manual*.

Table 1. Units as a Function of Display Format

DISPLAY FORMAT	MARKER MODE	OUTPMARK value 1, value 2	OUTPFORM value 1, value 2	MARKET READOUT** value, aux value
LOG MAG		dB,*	dB,*	dB,*
PHASE		degrees,*	degrees,*	degrees,*
DELAY		seconds,*	seconds,*	seconds,*
SMITH CHART	LIN MKR LOG MKR Re/Im R + jX G + jB	lin mag, degrees dB, degrees real, imag real, imag ohms real, imag Siemens	real, imag " " " "	lin mag, degrees dB, degrees real, imag real, imag ohms real, imag Siemens
POLAR	LIN MKR LOG MKR Re/Im	lin mag, degrees dB, degrees real, imag	real, imag " "	lin mag, degrees dB, degrees real, imag
LIN MAG		lin mag,*	lin mag,*	lin mag,*
REAL		real,*	real,*	real,*
SWR		SWR,*	SWR,*	SWR,*
<p>* Value not significant in this format, but is included in data transfers.</p> <p>** The marker readout values are the marker values displayed in the upper right-hand corner of the display. They also correspond to the value and aux value associated with the fixed marker.</p>				

Table 2. Entering IO Routine Summary

ROUTINE	DATA TYPE	MAX%	FLAG %
IOENTER	one real	—	no
IOENTERA	array of reals	number of reals	no
IOENTERAB	unformatted	number of bytes*	yes
IOENTERB	unformatted	number of bytes	yes
IONETERS	character string	number of characters	no
<p>* IOENTERAB will only read out as many bytes as are indicated by the last two bytes of the header (the number of bytes in the block to follow). However, if MAX% is less than this number, the transfer will terminate once MAX% bytes have been read out (MAX% is used as a safeguard to prevent longer-than-anticipated data from over-running the data array).</p>			

### Example 3A: Data transfer using form 4, ASCII transfer format

The following program illustrates how to transfer data using *form 4*. *Form 4* transfers two numbers for each trace point, each number of the transfer data as a 24-character string, each character being a digit, sign, or decimal point. *Form 4* does not use a header. The first of two eleven-point transfers uses *OUTPFORM* to read out magnitude data. This eleven-point transfer with two real numbers per point and 24 bytes per point takes 528 (11\*2\*24) bytes. The second transfer uses *OUTPLIML* to read out limit data. (*OUTPLIML* reads out the stimulus frequency, result, upper limit, and lower limit of limit data.) Note that stimulus values can be read using this command even though no limits have been set. This eleven-point transfer with four real numbers per point and 24 bytes per point takes 1056 (11\*4\*24) bytes.

This example program is stored on the Example Programs disk as **IPG3A.BAS**.

10	REM \$INCLUDE: 'QBSETUP'	Call the QuickBASIC initialization file QBSETUP.
20	CLS	Clear the computer CRT.
30	ISC& = 7	Assign the interface select code to a variable.
40	VNA& = 716	Assign the analyzer's address to a variable.
50	CONST SIZE% = 11	Set a constant to the number of points to be used in the trace.
60	CALL IOTIMEOUT(ISC&, 10!): GOSUB ERRORTRAP	Define a system time-out of ten seconds and perform error trapping.
70	CALL IOABORT(ISC&): GOSUB ERRORTRAP	Abort any HP-IB transfers and perform error trapping.
80	CALL IOCLEAR(ISC&): GOSUB ERRORTRAP	Clear the analyzer's HP-IB interface and perform error trapping.
90	CALL IOEOI(ISC&, 0): GOSUB ERRORTRAP	Disable the End-Or-Identify mode for transferring data and perform error trapping.
100	A\$ = "PRES;": GOSUB IOOUTS	Preset the network analyzer.
110	DIM DAT!(1 TO 2, 1 TO SIZE%), STIM!(1 TO 4, 1 TO SIZE%)	Prepare arrays to receive the data. All IOENTER routines that fill arrays do so column by column. For example DAT! will be filled in the order DAT!(1, 1), DAT!(2, 1), DAT!(1, 2), etc. Noting this, dimension the array such that the data will be properly grouped.
120	A\$ = "POIN " + STR\$(SIZE%) + "; SING; FORM4; OUTPFORM;": GOSUB IOOUTS	Set the number of points in the trace to SIZE%, sweep once, and then hold. Tell the analyzer to send out formatted data in <i>form 4</i> , the ASCII transfer format.
130	MAX% = 2 * SIZE%	The maximum number of real numbers to be read in is two per point with SIZE% points.
140	ACTUAL% = 0	Initialize the actual number of real numbers read in. This variable is given a value by IOENTERA.
150	CALL IOENTERA(VNA&, SEG DAT!(1, 1), MAX%, ACTUAL%): GOSUB ERRORTRAP	Read the trace data into the array. The first field is the magnitude in dB.
160	A\$ = "OUTPLIML;": GOSUB IOOUTS	Tell the analyzer to send out the limit test data for each point.
170	MAX% = 4 * SIZE%	The maximum number of real numbers to be read in during the next transfer is four per point with SIZE% points.
180	ACTUAL% = 0	Re-initialize the actual number of real numbers read in.

190 CALL IDENTERA(VNA&, SEG STIM!(1, 1), MAX%, ACTUAL%): GOSUB ERRORTRAP	Read the trace data into the array. The first field is the frequency in Hz.
200 PRINT TAB(5); "#"; TAB(13); "MAGNITUDE"; TAB(27); "FREQUENCY"	
210 PRINT TAB(15); "(dB)"; TAB(29); "(Hz)": PRINT	Display the table heading.
220 FOR I% = 1 TO SIZE%	Display the data for each trace point in a table on the computer CRT.
230 PRINT USING "#####"; I%;	Display the trace point index in the desired format. For an explanation of QuickBASIC format statements, see the section entitled <i>Formatting Numbers</i> in <i>Microsoft QuickBASIC: Basic Language Reference</i> .
240 PRINT " "; : PRINT USING "+###.#####"; DAT!(1, I%);	Display the trace point magnitude in the desired format.
250 PRINT " "; : PRINT USING "###.#####"; STIM!(1, I%)	Display the trace point frequency in the desired format.
260 NEXT I%	
270 CALL IOLOCAL(ISC&): GOSUB ERRORTRAP	Return the network analyzer to local mode and perform error trapping.
280 END	End program execution.
290 ERRORTRAP:	Define a routine to trap errors.
300 IF PCIB.ERR <> NOERR THEN ERROR PCIB.BASERR	Perform error trapping.
310 RETURN	Return from the ERRORTRAP routine.
320 IOOUTS:	Define a routine to send a command string from the computer to the analyzer.
330 CALL IOOUTPUTS(VNA&, A\$, LEN(A\$)): GOSUB ERRORTRAP	Send the command string A\$ out to the analyzer and perform error trapping.
340 RETURN	Return from the IOOUTS routine.

### Running the program

1. The computer presets the analyzer and resets the trace to eleven points.
2. The computer reads in the trace data requested by OUTPFORM. The first number for each point is the magnitude in dB. Regardless of the number of significant digits transmitted, the network analyzer only measures magnitude to a resolution of 0.001 dB, phase to 0.01 degrees, and group delay to 0.01 psec.
3. The computer reads in the trace data read out by OUTPLIML. The first number for each point is the frequency in Hz.
4. The computer displays the magnitude and frequency at the eleven points of the trace in a table.

### Example 3B: Data transfer using form 5, PC-DOS 32-bit floating point format

The following program illustrates how to transfer data using *form 5*. *Form 5* transfers two numbers for each trace point, each number as a four-byte real number, and it uses a header, so the receiving array DAT! is set up to accommodate it. One 201-point transfer is done using OUTPFORM to read out magnitude data. This 201-point transfer with two real numbers per point and four bytes per point plus a four-byte header takes 1612 (201\*2\*4 + 4) bytes. Note that this same transfer in *form 4* would take 9648 (201\*2\*24) bytes.

This example program is stored on the Example Programs disk as IPG3B.BAS.

10	REM \$INCLUDE: 'QBSETUP'	Call the QuickBASIC initialization file QBSETUP.
20	CLS	Clear the computer CRT.
30	ISC& = 7	Assign the interface select code to a variable.
40	VNA& = 716	Assign the analyzer's address to a variable.
50	CALL IOTIMEOUT(ISC&, 10!): GOSUB ERRORTRAP	Define a system time-out of ten seconds and perform error trapping.
60	CALL IOABORT(ISC&): GOSUB ERRORTRAP	Abort any HP-IB transfers and perform error trapping.
70	CALL IOCLEAR(ISC&): GOSUB ERRORTRAP	Clear the analyzer's HP-IB interface and perform error trapping.
80	CALL IOEDI(ISC&, 0): GOSUB ERRORTRAP	Disable the End-Or-Identify mode for transferring data and perform error trapping.
90	DIM DAT!(1 TO 2, 0 TO 201)	Prepare an array to receive the data, leaving at least four bytes of space before the desired data destination to account for the two-integer header.
100	A\$ = "SING; FORMS; OUTPFORM;": GOSUB IOOUTS	Sweep once and then hold. Tell the analyzer to send out formatted data in <i>form 5</i> , PC-DOS 32-bit floating point.
110	MAX% = 201 * 4 * 2 + 4	The maximum number of bytes to be read in is two 4-byte real numbers per point with 201 points plus a four-byte (two-integer) header.
120	ACTUAL% = 0	Initialize the actual number of bytes read in. This variable is given a value by IOENTERB.
130	FLAG% = 1	No swapping of bytes is desired.
140	CALL IOENTERB(VNA&, SEG DAT!(2, 0), MAX%, ACTUAL%, FLAG%): GOSUB ERRORTRAP	Read in the data, specifying the beginning array address as one real number (four bytes) before the desired destination of the true data in order to account for the header and therefore maintain data grouping.
150	PRINT USING "+###.#####"; DAT!(1, 1); DAT!(1, 201)	Display the first and last data point values. Only the first value of the pair of numbers for each point (the magnitude in dB) is significant.
160	A\$ = "CONT;": GOSUB IOOUTS	Restore continuous sweep trigger mode to the analyzer.
170	CALL IOLOCAL(ISC&): GOSUB ERRORTRAP	Return the network analyzer to local mode and perform error trapping.
180	END	End program execution.
190	ERRORTRAP:	Define a routine to trap errors.
200	IF PCIB.ERR <> NOERR THEN ERROR PCIB.BASERR	Perform error trapping.
210	RETURN	Return from the ERRORTRAP routine.
220	IOOUTS:	Define a routine to send a command string from the computer to the analyzer.

230 CALL IOOUTPUTS(VNA&, A\$, LEN(A\$)): GOSUB ERRORTRAP	Send the command string A\$ out to the analyzer and perform error trapping.
240 RETURN	Return from the IOOUTS routine.

### Running the program

1. The computer reads in the trace data requested by OUTPFORM in *form 5*. The first number for each point is the magnitude in dB.
2. The computer displays the first and last magnitude values read in.

Now go to the analyzer and press [MENU] [NUMBER OF POINTS] [4] [0] [1] [x1]. Run the program again. Note that although the program does not generate an error, only half of the data was read in since the computer only expected the data for 201 points. In this case the analyzer is still waiting to transfer data.

Now change the number of points to 101. Run the program again. Note that a QuickBASIC error was generated since the analyzer ran out of data to transmit before the computer received the data from 201 points that it was expecting.

It is imperative that the receiving array be correctly dimensioned. Fortunately, this is easy to ensure because not only is the number of points in the analyzer's trace readily available through PDIN?, but the size of the transfer block is also easily determined from the header. In addition, QuickBASIC allows dimension statements anywhere in a program, so it is possible to wait until the size of the transfer is known to dimension the receiving array.

The above example program can be modified to take advantage of this by making the following changes:

- Change line 90 to the following:
 

90 DIM HEADER%(0 TO 1)	Prepare an array to receive the two-integer header.
------------------------	---
- Delete line 110.
- Insert the following lines between lines 100 and 120:
 

102 MAX% = 4	The maximum number of bytes to be read in is only the four byte header.
105 ACTUAL% = 0	Initialize the actual number of bytes read in. This variable is given a value by IOENTERB.
108 FLAG% = 1	No swapping of bytes is desired.
110 CALL IOENTERB(VNA&, SEG HEADER%(0), MAX%, ACTUAL%, FLAG%): GOSUB ERRORTRAP	Read in the header as two integers. The second integer is the number of bytes of the trace data that would follow if MAX% were not set to read in only the header.
112 DIM DAT!(1 TO 2, 0 TO HEADER%(1) / 8)	Prepare an array to receive the data. The necessary size of the array can be determined from the known number of bytes of the trace data. (There are HEADER%(1) bytes with four bytes per real number and two real numbers per point.)
115 A\$ = "OUTPFORM;": GOSUB IOOUTS	Tell the analyzer to send out data formatted data in <i>form 5</i> , PC-DOS 32-bit floating point.
118 MAX% = HEADER%(1) + 4	The maximum number of bytes to be read in is the number of bytes following the header, given by HEADER%(1), plus the four bytes in the header.

This modified program is stored on the Example Programs disk as **IPG3BX.BAS**.

Two transfers are done using OUTPFORM. The first transfer reads in only the four-byte header (as two integers) before it terminates. The second of these integers is the size in bytes of the block of data to follow, and with this the receiving array can be correctly dimensioned regardless of the number of points in the trace.

### Example 3C: Data transfer using form 1, network analyzer internal format

The following program illustrates how to transfer data using *form 1*. *Form 1* transfers a six-byte binary string of data for each trace point. The six bytes can be represented as three integers, and *form 1* uses a four-byte header, which can be read in as two integers, so the receiving array DAT! is set up to accommodate this. One transfer is done using OUTPDATA to determine the size of the data block. The receiving array is then correctly dimensioned, and a second transfer is done using OUTPDATA to receive all of the trace data. If there is a 201-point trace, with six-bytes per point plus a four-byte header, this transfer takes only 1210 (201\*6 + 4) bytes. This is considerably faster than the same transfer in either *form 4* or *form 5*.

However, the data received in *form 1* is difficult to decode. Real/imaginary data uses the first two bytes for the imaginary fraction mantissa, the middle two bytes for the real fraction mantissa, the fifth byte for additional resolution when transferring raw data, and the last byte as the common power of two. The data could be recombined and displayed on the computer, but since this requires reformatting time, *form 1* is most useful for getting data to store on disk, as shown in the following program.

This example program is stored on the Example Programs disk as IPG3C.BAS.

10	REM \$INCLUDE: 'QBSETUP'	Call the QuickBASIC initialization file QBSETUP.
20	CLS	Clear the computer CRT.
30	ISC& = 7	Assign the interface select code to a variable.
40	VNA& = 716	Assign the analyzer's address to a variable.
50	CALL IOTIMEOUT(ISC&, 10!): GOSUB ERRORTRAP	Define a system time-out of ten seconds and perform error trapping.
60	CALL IOABORT(ISC&): GOSUB ERRORTRAP	Abort any HP-IB transfers and perform error trapping.
70	CALL IOCLEAR(ISC&): GOSUB ERRORTRAP	Clear the analyzer's HP-IB interface and perform error trapping.
80	CALL IOEDI(ISC&, 0): GOSUB ERRORTRAP	Disable the End-Or-Identify mode for transferring data and perform error trapping.
90	DIM HEADER%(0 TO 1)	Prepare an array to receive the four-byte header as two integers.
100	A\$ = "SING; FORM1; OUTPDATA;": GOSUB IOOUTS	Sweep once and then hold. Tell the analyzer to send out corrected data in <i>form 1</i> , instrument internal binary.
110	MAX% = 4	The maximum number of bytes to be read in is only the four-byte header.
120	ACTUAL% = 0	Initialize the actual number of bytes read in. This variable is given a value by IOENTERB.
130	FLAG% = 4	Reverse every four bytes.
140	CALL IOENTERB(VNA&, SEG HEADER%(0), MAX%, ACTUAL%, FLAG%): GOSUB ERRORTRAP	Read in the header as two integers. The first integer is the number of bytes of the trace data that would follow if MAX% were not set to read in only the header.
150	DIM DAT%(1 TO 3, 0 TO HEADER%(0) / 6)	Prepare an array to receive the data. The necessary size of the array can be determined from the known number of bytes of the trace data. (In addition to one four-byte header, there are six bytes per point in <i>form 1</i> , so allocate three integers per point.)
160	A\$ = "OUTPDATA;": GOSUB IOOUTS	Tell the analyzer to send out corrected data in <i>form 1</i> , instrument internal binary.



170 MAX% = HEADER%(0) + 4	The maximum number of bytes to be read in is the number of bytes following the header, given by HEADER%(0), plus four bytes in the header.
180 ACTUAL% = 0	Re-initialize the actual number of bytes read in.
190 FLAG% = 1	Because the data is only going to be stored in a file and not seen, no swapping of bytes is necessary.
200 CALL IDENTERB(VNA&, SEG DAT%(2, 0), MAX%, ACTUAL%, FLAG%): GOSUB ERRORTRAP	Read in the data, specifying the beginning array address as two integers (four bytes) before the desired destination of the true data in order to account for the header and therefore maintain data grouping.
210 OPEN "TESTDATA" FOR BINARY AS #1	Open the binary storage file.
220 PUT #1, , HEADER%(0)	Store the number of bytes of the trace data in the storage file.
230 PUT #1, , DAT%(2, 0)	Store the four-byte header in the storage file as two integers.
240 PUT #1, , DAT%(3, 0)	
250 FOR I% = 1 TO HEADER%(0) / 6	
260 PUT #1, , DAT%(1, I%)	Store the trace data in the storage file.
270 PUT #1, , DAT%(2, I%)	
280 PUT #1, , DAT%(3, I%)	
290 NEXT I%	
300 CLOSE #1	Close the storage file.
310 PRINT "CHANGE SETUP AND PRESS <ENTER>."	Display instructions on the computer CRT.
320 DO UNTIL INKEY\$ = CHR\$(13): LOOP	Wait for the operator to change the trace.
330 OPEN "TESTDATA" FOR BINARY AS #1	Open the binary storage file.
340 GET #1, , HEADER%(0)	Read the number of bytes of trace data from the storage file.
350 GET #1, , DAT%(2, 0)	Read the header from the storage file.
360 GET #1, , DAT%(3, 0)	
370 FOR I% = 1 TO (HEADER%(0) / 6)	
380 GET #1, , DAT%(1, I%)	Read the trace data from the storage file.
390 GET #1, , DAT%(2, I%)	
400 GET #1, , DAT%(3, I%)	
410 NEXT I%	
420 CLOSE #1	Close the storage file.
430 A\$ = "SING;": GOSUB IDOUTS	Sweep once to view the current setup's trace on the analyzer and then hold.
440 PRINT "PRESS <ENTER> TO CONTINUE.": DO UNTIL INKEY\$ = CHR\$(13): LOOP	Allow the operator to view the current setup's trace before continuing.
450 A\$ = "INPUDATA;": GOSUB IDOUTS	Prepare the analyzer to read in corrected data.
460 MAX% = HEADER%(0) + 4	The maximum number of bytes to be sent out is the number of bytes following the header, given by HEADER%(0), plus the four bytes in the header.
470 FLAG% = 1	No swapping of bytes is desired.

480 CALL IOOUTPUTB(VNA&, SEG DAT%(2, 0), MAX%, FLAG%): GOSUB ERRORTRAP	Send out the data, specifying the beginning array address as two integers (four bytes) before the address where the true data is stored in order to account for the header.
490 KILL "TESTDATA"	Delete the data file.
500 CALL IOLOCAL(ISC&): GOSUB ERRORTRAP	Return the network analyzer to local mode and perform error trapping.
510 END	End program execution.
520 ERRORTRAP:	Define a routine to trap errors.
530 IF PCIB.ERR <> NOERR THEN ERROR PCIB.BASERR	Perform error trapping.
540 RETURN	Return from the ERRORTRAP routine.
550 IOOUTS:	Define a routine to send a command string from the computer to the analyzer.
560 CALL IOOUTPUTS(VNA&, A\$, LEN(A\$)): GOSUB ERRORTRAP	Send the command string A\$ out to the analyzer and perform error trapping.
570 RETURN	Return from the IOOUTS routine.

### Running the program

1. The computer initiates a transfer using OUTPDATA, reads in the four-byte header as two integers, and terminates the transfer. The second of these integers is the size in bytes of the block of data to follow, and with this, the receiving array is correctly dimensioned.
2. The computer reads in all the trace data requested by OUTPDATA.
3. The computer stores the size of the block of data and the data in the hard disk file TESTDATA. If a hard disk is not available, change the file name on lines 210 and 330 to A:TESTDATA, and make sure that there is a formatted non-write-protected) disk in the A: drive.
4. Change the setup on the analyzer as prompted by the computer by, for example, disconnecting the test device.
5. The computer reads the trace data back in from the storage file, sends the data out to the analyzer, and deletes the storage file.

### Example 3D: Data transfer using markers

The following program illustrates how to transfer data using markers and the command OUTPMARK. In order to read data off a trace using a marker, the marker must first be made active and put at the desired frequency using a command to select a specific stimulus value, like MARK1 133.15MHZ, or a command to do a marker search, like MARK3; SEAMIN. The command OUTPMARK tells the network analyzer to transmit three numbers: marker value one, marker value two, and marker stimulus value. See Table 1 (page 20) to identify the first two marker values according to the current display format. The third marker value, the stimulus value, is either frequency or time, depending on the network analyzer's active domain. These three values can be read in as an array of real numbers using the routine IOENTERA. In this case, there is no header, and MAX% is the maximum number of real numbers to read in (3).

This Example Program is stored on the Example Programs disk as **IPG3D.BAS**.

10	REM \$INCLUDE: 'QBSETUP'	Call the QuickBASIC initialization file QBSETUP.
20	CLS	Clear the computer CRT.
30	ISC& = 7	Assign the interface select code to a variable.
40	VNA& = 716	Assign the analyzer's address to a variable.
50	DISPLAY& = 717	Assign the analyzer's display address to a variable.
60	CALL IOTIMEOUT(ISC&, 10!): GOSUB ERRORTRAP	Define a system time-out of ten seconds and perform error trapping.
70	CALL IOABORT(ISC&): GOSUB ERRORTRAP	Abort any HP-IB transfers and perform error trapping.
80	CALL IOCLEAR(ISC&): GOSUB ERRORTRAP	Clear the analyzer's HP-IB interface and perform error trapping.
90	CALL IOEOI(ISC&, 0): GOSUB ERRORTRAP	Disable the End-Or-Identify mode for transferring data and perform error trapping.
100	DIM VALU!(0 TO 2)	Allocate space to hold data read in from the analyzer.
110	ADDRESS& = VNA&	Initialize the output address to the address of the network analyzer.
120	A\$ = "PRES;": GOSUB IOOUTS	Preset the network analyzer.
130	A\$ = "CHAN1; S21; LOGM;": GOSUB IOOUTS	Make channel 1 the active channel and measure the magnitude of forward transmission parameter S21 in decibels.
140	A\$ = "CENT 134MHz;": GOSUB IOOUTS	Set the center frequency to 134 MHz.
150	A\$ = "SPAN 25MHz;": GOSUB IOOUTS	Set the frequency span to 25 MHz.
160	A\$ = "AUTO;": GOSUB IOOUTS	Autoscale the resulting trace.
170	A\$ = "SING; MARK3; SEAMIN;": GOSUB IOOUTS	Sweep once, hold, and set marker three at the minimum magnitude value of the trace.
180	A\$ = "MARK4; SEAMAX;": GOSUB IOOUTS	Set marker four at the maximum magnitude value of the trace.
190	A\$ = "MARK1 133.15MHz; OUTPMARK;": GOSUB IOOUTS	Set marker one at 133.15 MHz, sweep once, and request marker data from marker one. Since the format is log magnitude, only the first value (the magnitude at the marker in dB) and the third value (the frequency in Hz) read in are significant. → See Table 1.

200 MAX% = 3	Set the maximum number of real numbers to be read in from the analyzer.
210 ACTUAL% = 0	Initialize the actual number of real numbers read in. This variable is given a value by IDENTERA.
220 CALL IDENTERA(VNA&, SEG VALU!(0), MAX%, ACTUAL%): GOSUB ERRORTRAP	Read in marker data from the analyzer.
230 PRINT " MARKER AT 133.15 MHz:"	
240 PRINT " FROM LOG MAGNITUDE PLOT:"	Display a heading.
250 PRINT TAB(15); VALU!(0); " DB"	Display the magnitude value just read in.
260 GOSUB WAITING	Wait for the user to press any network analyzer key before continuing.
270 A\$ = "PHAS; AUTO;": GOSUB IDOUTS	Display the phase of the active transmission parameter and autoscale the resulting trace.
280 A\$ = "MARK1; OUTPMARK;": GOSUB IDOUTS	Request marker data from marker one. Since the format is phase, only the first value (the phase at the marker in degrees) and the third value (the frequency in Hz) read in are significant. → See Table 1. Note that a single sweep / hold is not necessary here because only format has changed.
290 ACTUAL% = 0	Re-initialize the actual number of real numbers read in.
300 CALL IDENTERA(VNA&, SEG VALU!(0), MAX%, ACTUAL%): GOSUB ERRORTRAP	Read in marker data from the analyzer.
310 PRINT " FROM PHASE PLOT:"	Display a heading.
320 PRINT TAB(15); VALU!(0); " DEGREES"	Display the phase value just read in.
330 GOSUB WAITING	Wait for the user to press any network analyzer key before continuing.
340 A\$ = "LINM; AUTO;": GOSUB IDOUTS	Display the linear magnitude of the active transmission parameter and autoscale the resulting trace.
350 A\$ = "MARK1; OUTPMARK;": GOSUB IDOUTS	Request marker data from marker one. Since the format is linear magnitude, only the first value (the linear magnitude) and the third value (the frequency in Hz) read in are significant. → See Table 1.
360 ACTUAL% = 0	Re-initialize the actual number of real numbers read in.
370 CALL IDENTERA(VNA&, SEG VALU!(0), MAX%, ACTUAL%): GOSUB ERRORTRAP	Read in marker data from the analyzer.
380 PRINT " FROM LINEAR MAGNITUDE PLOT:"	Display a heading.
390 PRINT TAB(15); VALU!(0); " UNITS"	Display the magnitude value just read in.
400 GOSUB WAITING	Wait for the user to press any network analyzer key before continuing.

410 A\$ = "SMIC; AUTO; SMIMRX;": GOSUB IOOOTS	Display the Smith chart of the active transmission parameter and autoscale the trace. Set the marker data to be given in the form $R + jX$ .
420 A\$ = "MARK1; OUTPMARK;": GOSUB IOOOTS	Request marker data from marker one. In this configuration, the first value (real in ohms), the second value (imaginary in ohms), and the third value (the frequency in Hz) read in are significant. → See Table 1.
430 ACTUAL% = 0	Re-initialize the actual number of real numbers read in.
440 CALL IOENTERA(VNA&, SEG VALU!(0), MAX%, ACTUAL%): GOSUB ERRORTRAP	Read in marker data from the analyzer.
450 PRINT " FROM SMITH CHART:"	Display a heading.
460 PRINT TAB(15); VALU!(0); " + j "; VALU!(1); " OHMS"	Display the normalized impedance values just read in.
470 GOSUB WAITING	Wait for the user to press any network analyzer key before continuing.
480 A\$ = "POLA; AUTO; POLMRI;": GOSUB IOOOTS	Display the active transmission parameter in polar form and autoscale the trace. Set the marker data to be in the form real/imaginary.
490 A\$ = "MARK1; OUTPMARK;": GOSUB IOOOTS	Request marker data from marker one. In this configuration, the first value (real), the second value (imaginary), and the third value (the frequency in Hz) read in are significant. → See Table 1.
500 ACTUAL% = 0	Re-initialize the actual number of real numbers read in.
510 CALL IOENTERA(VNA&, SEG VALU!(0), MAX%, ACTUAL%): GOSUB ERRORTRAP	Read in marker data from the analyzer.
520 PRINT " FROM POLAR PLOT:"	Display a heading.
530 PRINT TAB(15); VALU!(0); " + j "; VALU!(1); " UNITS"	Display the values just read in.
540 CALL IOLOCAL(ISC&): GOSUB ERRORTRAP	Return the network analyzer to local mode and perform error trapping.
550 END	Perform error trapping.
560 ERRORTRAP:	Define a routine to trap errors.
570 IF PCIB.ERR <> NOERR THEN ERROR PCIB.BASERR	Perform error trapping.
580 RETURN	Return from the ERRORTRAP routine.
590 IOOOTS:	Define a routine to send a command string from the computer to the analyzer.
600 CALL IOOUTPUTS(ADDRESS&, A\$, LEN(A\$)): GOSUB ERRORTRAP	Send the command string A\$ out to the analyzer and perform error trapping.
610 RETURN	Return from the IOOOTS routine.
620 WAITING:	Define a routine to display a prompt on the network analyzer's display and wait for the user to press any key before continuing.
630 ADDRESS& = DISPLAY&	Reset the output address to the network analyzer's display.

640 A\$ = "PU; PA 390,3600; PD; LBPRESS ANY KEY TO CONTINUE" + CHR\$(3): GOSUB IOOOTS	Write a prompt on the network analyzer's display.
650 ADDRESS& = VNA&	Return the output address to the network analyzer.
660 A\$ = "CLES; ESE64;": GOSUB IOOOTS	Set up the status reporting system so that bit 6, User Request, of the Event Status Register is summarized by bit 5 of the Status Byte, allowing a key press to be detected by a serial poll.
670 A\$ = "ESR?;": GOSUB IOOOTS	Request the Event Status Register value from the analyzer.
680 CALL IOENTER(VNA&, ESTAT!): GOSUB ERRORTRAP	Receive the Event Status Register value from the analyzer, thereby clearing the latched User Request bit so that old key presses will not trigger a measurement.
690 STAT% = 0	Initialize STAT% for entry into the DO UNTIL loop.
700 DO UNTIL ((STAT% MOD 64) > 31)	Wait for a key press to be indicated by the setting of bit 5 in the status byte. MOD 64 removes the effect of all higher value bits (bit 6 is equivalent to 64 in decimal), and > 31 ensures that bit 5, which is equivalent to 32 in decimal, is set.
710 CALL IOSPOLL(VNA&, STAT%): GOSUB ERRORTRAP	Read in the status byte as an integer.
720 LOOP	
730 ADDRESS& = DISPLAY&	Reset the output address to the network analyzer's display.
740 A\$ = "PG;": GOSUB IOOOTS	Clear old user graphics from the network analyzer's display.
750 ADDRESS& = VNA&	Return the output address to the network analyzer.
760 RETURN	Return from the WAITING routine.

### Running the program

1. The computer sets up a trace on the analyzer and puts markers at the maximum and minimum log magnitudes of the trace as well as at a specific frequency.
2. The computer reads in the data from marker one read out by OUTPMARK. Press any key on the analyzer front panel to continue the program, go on to a new display format, and read in its data from marker one. Note that only the identity of the first two marker data values varies with the current display format and marker mode; the command to read out the marker data, OUTPMARK and the number of values to be read (3) is always the same.

# Advanced Programming Examples

## Using list frequency mode

The network analyzer normally takes data points spaced at regular intervals across the overall frequency range of the measurement. For a 2 GHz linear frequency sweep with 201 points, data will be taken at intervals of 10 MHz. The list frequency mode, however, lets you select the specific points or frequency spacing between points at which measurements are to be made. This allows flexibility in setting up tests, and it reduces measurement time since device performance is not measured at frequencies not needed.

The following examples illustrate the use of the network analyzer's list frequency mode to perform arbitrary frequency testing. Example 4A constructs a table of list frequency segments which is then loaded into the network analyzer's list frequency table. Each segment stipulates a start frequency, a stop frequency, and the number of data points to be taken over that frequency range. The command sequence for entering a list frequency table imitates the key sequence followed when entering a table from the front panel in that there is a command for every key press. Editing a segment is also the same as the key sequence, and the network analyzer automatically reorders each edited segment in order of increasing start frequency.

Example 4B selects a specific segment of the list frequency table to "zoom-in" on. This is useful when a single instrument is being used to measure several different devices, each with its own frequency range. Using a single calibration performed with all of the segments active, each specific device can be measured by selecting the appropriate segment for that device.

The list frequency segments can be overlapped, but the number of points in all the segments must not exceed 1632 points. Also, the list frequency table is carried as part of the learn string. While it cannot be modified in this form, it can easily be stored and recalled.

### Example 4A: List frequency sweep

The following program illustrates how to create a list frequency table on the computer and transmit it to the analyzer. It takes advantage of the computer's ability to simplify creating, adding to, and editing the table. The table is entered and completely edited before it is transmitted to the analyzer. For simplicity, the options to enter center, span, and step size are not given.

This example program is stored on the Example Programs disk as **IPG4A.BAS**.

10	REM \$INCLUDE: 'QBSETUP'	Call the QuickBASIC initialization file QBSETUP.
20	CLS	Clear the computer CRT.
30	ISC& = 7	Assign the interface select code to a variable.
40	VNA& = 716	Assign the analyzer's address to a variable.
50	CALL IOTIMEOUT(ISC&, 10!): GOSUB ERRORTRAP	Define a system time-out of ten seconds and perform error trapping.
60	CALL IOABORT(ISC&): GOSUB ERRORTRAP	Abort any HP-IB transfers and perform error trapping.
70	CALL IOCLEAR(ISC&): GOSUB ERRORTRAP	Clear the analyzer's HP-IB interface and perform error trapping.
80	CALL IOEDI(ISC&, 0): GOSUB ERRORTRAP	Disable the End-Or-Identify mode for transferring data and perform error trapping.
90	LOCATE 1, 1: INPUT "NUMBER OF SEGMENTS? ", NUMBER%	Read in the desired number of segments from the operator's input.
100	DIM TABLE!(1 TO 3, 1 TO NUMBER%)	Create an array to hold the segment data (start frequency, stop frequency, and number of points for each segment).
110	GOSUB CLEARLINES	Clear the CRT lines being used for data entry.
120	LOCATE 5, 1: PRINT "SEGMENT"; TAB(15); "START(MHz)"; TAB(32); "STOP(MHz)"; TAB(49); "NUMBER OF POINTS";	Display the segment table header on the computer CRT.
130	FOR I% = 1 TO NUMBER%	Repeat for each segment in the segment list.

140	GOSUB LOADPOINT	Load the data for the current segment, TABLE!(1 TO 3, I%). Since LOADPOINT is a subroutine, I% is used as a global variable.
150	GOSUB CLEARDATA	Clear the current segment data from the CRT lines being used for data entry.
160	NEXT I%	
170	GOSUB CLEARLINES	Clear the CRT lines being used for data entry.
180	LOCATE 1, 1: INPUT "DO YOU WANT TO EDIT (Y/N)? ", ANSWER\$	Determine if editing is initially desired.
190	DO UNTIL ((ANSWER\$ = "N") OR (ANSWER\$ = "n"))	Repeat until all editing has been done.
200	INPUTENTRY: LOCATE 1, 40: INPUT "ENTRY NUMBER? ", I%	Get the number of the segment to be edited.
210	IF ((I% < 1) OR (I% > NUMBER%)) THEN GOTO INPUTENTRY	Make sure the segment number is valid.
220	GOSUB LOADPOINT	Re-enter the segment data.
230	GOSUB CLEARLINES	Clear the CRT lines being used for data entry.
240	LOCATE 1, 1: INPUT "DO YOU WANT TO EDIT (Y/N)? ", ANSWER\$	Determine if more editing is desired.
250	LOOP	
260	A\$ = "EDITLIST; CLEL;": GOSUB IOOUTS	To begin sending the table to the analyzer, open the analyzer's list frequency table for editing, and delete any existing segments.
270	FOR I% = 1 TO NUMBER%	Loop for each segment.
280	A\$ = "SADD; STAR " + STR\$(TABLE!(1, I%)) + "MHz;": GOSUB IOOUTS	
290	A\$ = "STOP " + STR\$(TABLE!(2, I%)) + "MHz;": GOSUB IOOUTS	
300	A\$ = "POIN " + STR\$(TABLE!(3, I%)) + ";": GOSUB IOOUTS	
310	A\$ = "SDON;": GOSUB IOOUTS	Add a segment, specifying its start frequency, its stop frequency, and the number of points it is made up of. Then declare the current frequency list segment done.
320	NEXT I%	
330	A\$ = "EDITDONE; LISFREQ;": GOSUB IOOUTS	Close the edit frequency list table and activate the list frequency mode.
340	A\$ = "AUTO;": GOSUB IOOUTS	Autoscale the trace.
350	CALL IDLOCAL(ISC&): GOSUB ERRORTRAP	Return the network analyzer to local mode and perform error trapping.
360	END	End program execution.
370	ERRORTRAP:	Define a routine to trap errors.
380	IF PCIB.ERR <> NOERR THEN ERROR PCIB.BASERR	Perform error trapping.
390	RETURN	Return from the ERRORTRAP routine.



400	IOOUTS:	Define a routine to send a command string from the computer to the analyzer.
410	CALL IOOUTPUTS(VNA&, A\$, LEN(A\$)): GOSUB ERRORTRAP	Send the command string A\$ out to the analyzer and perform error trapping.
420	RETURN	Return from the IOOUTS routine.
430	LOADPOINT:	Define a routine to read in all of one segment's data from the operator and load it into the data table on the computer.
440	GOSUB CLEARLINES	Clear the CRT lines being used for data entry.
450	LOCATE 1, 1: PRINT "SEGMENT: "; STR\$(I%); TAB(40); "STOP FREQUENCY (MHz)?"	
460	LOCATE 2, 1: PRINT "START FREQUENCY (MHz)?" ; TAB(40); "NUMBER OF POINTS?"	Display the input labels.
470	IF ((TABLE!(1, I%) <> 0) OR (TABLE!(2, I%) <> 0) OR (TABLE!(3, I%) <> 0)) THEN	If the segment contains valid data, display it at the entry locations.
480	LOCATE 2, 23: PRINT TABLE!(1, I%);	
490	LOCATE 1, 61: PRINT TABLE!(2, I%);	
500	LOCATE 2, 57: PRINT TABLE!(3, I%);	
510	END IF	
520	SAVE! = TABLE!(1, I%)	Save the start frequency of the current table entry.
530	LOCATE 2, 22: INPUT TABLE!(1, I%)	Read the start frequency of the segment.
540	IF TABLE!(1, I%) = 0 THEN TABLE!(1, I%) = SAVE!	If no value or 0 was entered, return the start frequency to its previous value.
550	LOCATE 2, 23: PRINT SPACE\$(16); LOCATE 2, 23: PRINT TABLE!(1, I%);	Display the new start frequency.
560	SAVE! = TABLE!(2, I%)	Save the stop frequency of the current table entry.
570	LOCATE 1, 60: INPUT TABLE!(2, I%)	Read the stop frequency of the segment.
580	IF TABLE!(2, I%) = 0 THEN TABLE!(2, I%) = SAVE!	If no value or 0 was entered, return the stop frequency to its previous value.
590	LOCATE 1, 61: PRINT SPACE\$(19); LOCATE 1, 61: PRINT TABLE!(2, I%);	Display the new stop frequency.
600	SAVE! = TABLE!(3, I%)	Save the number of points of the current table entry.
610	TABLE!(3, I%) = 0	Set TABLE!(3, I%) for entry into the DO UNTIL loop.
620	DO UNTIL (TABLE!(3, I%) > 0)	Repeat until a valid number of points has been entered.
630	LOCATE 2, 56: INPUT TABLE!(3, I%)	Read the number of points in the segment.

640 IF ((TABLE!(3, I%) = 0) AND (SAVE! <> 0)) THEN TABLE!(3, I%) = SAVE!	If no value or 0 was entered and the previous value was valid, return the number of points to that previous value.
650 LOOP	
660 LOCATE 2, 57: PRINT SPACE\$(23): LOCATE 2, 57: PRINT TABLE!(3, I%);	Display the new number of points.
670 IF (TABLE!(3, I%) = 1) THEN TABLE!(2, I%) = TABLE!(1, I%)	If there is only one point in the segment, let the stop frequency equal the start frequency to avoid ambiguity.
680 LOCATE I% + 5, 3: PRINT I%; TAB(17); TABLE!(1, I%); TAB(34); TABLE!(2, I%); TAB(54); TABLE!(3, I%);	Display the new data in the table.
690 RETURN	Return from the LOADPOINT routine.
700 CLEARLINES:	Define a routine to clear the CRT lines used for data entry.
710 FOR J% = 1 TO 3	Clear each line.
720 LOCATE J%, 1: PRINT SPACE\$(80);	
730 NEXT J%	
740 RETURN	Return from the CLEARLINES routine.
750 CLEARDATA:	Define a routine to clear only the data (not the prompts) from the CRT lines used for data entry.
760 LOCATE 1, 61: PRINT SPACE\$(19): LOCATE 2, 23: PRINT SPACE\$(16);	
770 RETURN	Return from the CLEARDATA routine.

### Running the program

1. The computer clears the analyzer's list frequency table. If this is not desired, remove the CLEL command from line 90.
2. Enter the number of segments and then the parameters of each segment as prompted.
3. Edit the computer's list frequency table until it is satisfactory. Pressing <ENTER> at a prompt during editing leaves the parameter at its current value.
4. The computer sends the completed list frequency table out to the analyzer, which orders the segments, activates the list frequency mode, and displays an all-segment sweep.

## Example 4B: Single segment selection

The following program illustrates how to read the list frequency table data out of the network analyzer and choose a single segment out of this table of segments to be the operating frequency range of the network analyzer. It is assumed that a list frequency table has already been entered into the analyzer, either manually or over HP-IB as shown in the previous example.

This example program is stored on the Example Programs disk as **IPG4B.BAS**.

10	REM \$INCLUDE: 'QBSETUP'	Call the QuickBASIC initialization file QBSETUP.
20	CLS	Clear the computer CRT.
30	ISC& = 7	Assign the interface select code to a variable.
40	VNA& = 716	Assign the analyzer's address to a variable.
50	CALL IOTIMEOUT(ISC&, 20!): GOSUB ERRORTRAP	Define a system time-out of twenty seconds and perform error trapping. This time-out is longer than usual because when there are many points, the HP 8752A factory correction takes more than 10 seconds to adjust to a new frequency range. If the timeout is set to only 10 seconds, a time-out error may be generated when nothing is wrong.
60	CALL IDABORT(ISC&): GOSUB ERRORTRAP	Abort any HP-IB transfers and perform error trapping.
70	CALL IDCLEAR(ISC&): GOSUB ERRORTRAP	Clear the analyzer's HP-IB interface and perform error trapping.
80	CALL IOEQI(ISC&, 0): GOSUB ERRORTRAP	Disable the End-Or-Identify mode for transferring data and perform error trapping.
90	LOCATE 2, 1: PRINT TAB(4); "SEGMENT"; TAB(22); "START (MHz)"; TAB(42); "STOP (MHz)"; TAB(59); "NUMBER OF POINTS"	Display the table heading.
100	A\$ = "EDITLIST; SEDI30; SEDI?": GOSUB IDOUTS	Request segment 30, the largest possible segment number, and the analyzer will automatically select the last segment. Then output its number to the computer.
110	CALL IDENTER(VNA&, NUMSEGS!): GOSUB ERRORTRAP	Because there is no HP-IB Command Library routine to read in an integer, read the last segment number into the real variable NUMSEGS!.
120	NUMSEGS% = INT(NUMSEGS!)	Convert the number of segments to an integer.
130	DIM TABLE!(1 TO 3, 1 TO NUMSEGS%)	Create an array to hold all of the segment parameters.
140	FOR I% = 1 TO NUMSEGS%	Read the segment parameters from the analyzer for each segment.
150	GOSUB READLIST	
160	NEXT I%	
170	LOCATE 1, 1: INPUT "SELECT SEGMENT NUMBER (0 TO EXIT): ", SEGMENT%	Determine which segment the operator wishes to activate. Entering 0 exits the loop.
180	DO UNTIL (SEGMENT% = 0)	Repeat until the operator enters 0.
190	LOCATE 3, 1: PRINT SPACE\$(80);	Clear the current segment display line on the computer CRT.
200	IF ((NUMSEGS% > 20) AND (SEGMENT% < 21)) THEN	Display the desired segment's data at the top of the table if it is not already on the display screen.
210	LOCATE 3, 1: PRINT USING "##"; TAB(6); SEGMENT%;	

220	PRINT USING "#####.###"; TAB(23); TABLE!(1, SEGMENT%) / 1000000; TAB(42); TABLE!(2, SEGMENT%) / 1000000;	
230	PRINT USING "#####"; TAB(65); TABLE!(3, SEGMENT%)	
240	END IF	
250	A\$ = "EDITDONE; SSEG" + STR\$(SEGMENT%) + ";"; GOSUB IOOUTS	Make the desired segment the new operating frequency range of the measurement.
260	A\$ = "AUTO;"; GOSUB IOOUTS	Autoscale the trace.
270	LOCATE 1, 36: PRINT SPACE\$(10);	Clear the segment number entry display.
280	LOCATE 1, 1: INPUT "SELECT SEGMENT NUMBER (0 TO EXIT): ", SEGMENT%	Determine which segment the operator wishes to activate.
290	LOOP	
300	A\$ = "ASEG;"; GOSUB IOOUTS	Resume operation using all list frequency segments.
310	A\$ = "AUTO;"; GOSUB IOOUTS	Autoscale the trace.
320	CALL IOLOCAL(ISC&): GOSUB ERRORTRAP	Return the network analyzer to local mode and perform error trapping.
330	END	End program execution.
340	ERRORTRAP:	Define a routine to trap errors.
350	IF PCIB.ERR <> NOERR THEN ERROR PCIB.BASERR	Perform error trapping.
360	RETURN	Return from the ERRORTRAP routine.
370	IOOUTS:	Define a routine to send a command string from the computer to the analyzer.
380	CALL IOOUTPUTS(VNA&, A\$, LEN(A\$)): GOSUB ERRORTRAP	Send the command string A\$ out to the analyzer and perform error trapping.
390	RETURN	Return from the IOOUTS routine.
400	READLIST:	Define a routine to read all of one segment's parameters from the analyzer and display them on the computer CRT.
410	A\$ = "EDITLIST; SEDI" + STR\$(I%) + ";"; GOSUB IOOUTS	Activate the I%th segment.
420	A\$ = "STAR?;"; GOSUB IOOUTS	Interrogate the start frequency of the analyzer.
430	CALL IOENTER(VNA&, TABLE!(1, I%)): GOSUB ERRORTRAP	Read the start frequency into the computer's list table.
440	A\$ = "STOP?;"; GOSUB IOOUTS	Interrogate the stop frequency of the analyzer.
450	CALL IOENTER(VNA&, TABLE!(2, I%)): GOSUB ERRORTRAP	Read the stop frequency into the computer's list table.

460 A\$ = "POIN?;": GOSUB IDOUTS	Interrogate the number of points of the analyzer.
470 CALL IDENTER(VNA&, TABLE!(3, I%): GOSUB ERRORTRAP	Read the number of points into the computer's list table.
480 IF (I% < 21) THEN	The first twenty segments will fit on the screen at once.
490 ROW% = 3 + I%	Set the segment data display row accordingly.
500 ELSEIF (I% = 21) THEN	There are too many segments to fit on the screen at once.
510 LOCATE 24, 1: PRINT "PRESS <ENTER> TO CONTINUE";	
520 DO UNTIL INKEY\$ = CHR\$(13): LOOP	Wait for the user to continue before clearing the screen.
530 FOR J% = 4 TO 24	Clear the lines used to display the data from the first twenty segments.
540 LOCATE J%, 1: PRINT SPACE\$(80);	
550 NEXT J%	
560 ROW% = 3 + (I% MOD 20)	Set the segment data display row accordingly.
570 ELSE	This is not one of the first twenty segments, so set the segment data display row accordingly.
580 ROW% = 3 + (I% MOD 20)	
590 END IF	
600 LOCATE ROW%, 1: PRINT USING "###"; TAB(6); I%;	
610 PRINT USING "#####.###"; TAB(23); TABLE!(1, I%) / 1000000; TAB(42); TABLE!(2, I%) / 1000000;	
620 PRINT USING "#####"; TAB(65); TABLE!(3, I%)	Display the segment parameters.
630 RETURN	Return from the READLIST routine.

### Running the program

1. The computer reads in the frequency list table segments from the analyzer and displays the data in a table. (It is assumed that a list frequency table has already been entered into the analyzer.)
2. Enter a segment number, as prompted, to view only that segment on the analyzer.
3. Continue entering and viewing single segments. Enter 0 at the prompt to exit the loop.
4. The computer restores all the segments on the analyzer by displaying an all-segment sweep.

## Using limit lines

To perform limit testing on the network analyzer over HP-IB, limits must first be loaded into the network analyzer. Then the limits can be activated and the device measured. The device's performance to the specified limits is signaled by a pass or fail message on the network analyzer display.

The following examples illustrate the use of the network analyzer to perform limit testing. Example 5A constructs a table of limit segments which is then loaded into the network analyzer's limit table. Each segment stipulates an upper limit, lower limit, limit type, and stimulus frequency. The command sequence for entering a limit table imitates the key sequence followed when entering a table from the front panel in that there is a command for every key press. Editing a limit is also the same as the key sequence, and the network analyzer automatically reorders the edited segments in order of increasing start frequency.

Example 5B performs limit testing by examining the limit/search fail bits which are set and latched when limit testing or a marker search fails. There are four bits, one for each channel for both limit testing and marker search. Their purpose is to allow the computer to determine whether the test/search just executed was successful. The sequence of their use is to clear Event Status Register B, to trigger the limit test or marker search, and then to check the appropriate fail bit.

The best ways to trigger the limit test are with a single sweep (SING) or with a set number of sweeps (NUMGn). Marker searches (max, min, target, and widths), however, are automatically triggered by reading out related marker or bandwidth values. Regardless of how the limit/search was triggered, the results can be found simply by checking the fail bit.

The limit table is carried as part of the learn string. While it cannot be modified in this form, it can easily be stored and recalled.

### Example 5A: Limit line setup

The following program illustrates how to create a limit table and transmit it to the network analyzer. It takes advantage of the computer's ability to simplify creating and editing the table. The table is entered and completely edited before being transmitted to the network analyzer. For simplicity, the option of entering offsets is not given.

This program is stored on the Example Programs disk as **IPG5A.BAS**.

10	REM \$INCLUDE: 'QBSETUP'	Call the QuickBASIC initialization file QBSETUP.
20	CLS	Clear the computer CRT.
30	ISC& = 7	Assign the interface select code to a variable.
40	VNA& = 716	Assign the analyzer's address to a variable.
50	CALL IOTIMEOUT(ISC&, 10!): GOSUB ERRORTRAP	Define a system time-out of ten seconds and perform error trapping.
60	CALL IOABORT(ISC&): GOSUB ERRORTRAP	Abort any HP-IB transfers and perform error trapping.
70	CALL IOCLEAR(ISC&): GOSUB ERRORTRAP	Clear the analyzer's HP-IB interface and perform error trapping.
80	CALL IOEDI(ISC&, 0): GOSUB ERRORTRAP	Disable the End-Or-Identify mode for transferring data and perform error trapping.
90	LOCATE 1, 1: INPUT "NUMBER OF LIMIT SEGMENTS? ", NUMBER%	Read in the desired number of limits from the operator.
100	DIM TABLE!(1 TO 4, 1 TO NUMBER%)	Create an array to hold the limit data (stimulus frequency value, upper limit value, lower limit value, and limit type code).
110	DIM LIMITTYPE\$(1 TO NUMBER%)	Create an array to hold the limit type string.
120	CLS	Clear the computer CRT.

<pre> 130 LOCATE 6, 1: PRINT TAB(3);     "SEGMENT"; TAB(15);     "STIMULUS (MHz)";     TAB(33); "UPPER (dB)";     TAB(49); "LOWER (dB)";     TAB(68); "TYPE"; 140 FOR IX = 1 TO NUMBER% 150 GOSUB LOADLIMIT  160 NEXT IX 170 GOSUB CLEARLINES 180 LOCATE 1, 1: INPUT "DO YOU     WANT TO EDIT (Y/N)? ",     ANSWER\$ 190 DO UNTIL ((ANSWER\$ = "N")     OR (ANSWER\$ = "n")) 200 INPUTENTRY: LOCATE 1, 40:     INPUT "ENTRY NUMBER? ",     IX 210 IF ((IX &lt; 1) OR (IX &gt;     NUMBER%)) THEN GOTO     INPUTENTRY 220 GOSUB LOADLIMIT 230 GOSUB CLEARLINES 240 LOCATE 1, 1: INPUT "DO YOU     WANT TO EDIT (Y/N)? ",     ANSWER\$ 250 LOOP 260 A\$ = "EDITLIML; CLEL;":     GOSUB IOOOTS 270 FOR IX = 1 TO NUMBER% 280 A\$ = "SADD; LIMS" +     STR\$(TABLE!(1, IX)) +     "MHZ;": GOSUB IOOOTS 290 A\$ = "LIMU" +     STR\$(TABLE!(2, IX)) +     "DB;": GOSUB IOOOTS 300 A\$ = "LIML" +     STR\$(TABLE!(3, IX)) +     "DB;": GOSUB IOOOTS 310 A\$ = "LIMT" +     LIMITTYPE\$(IX) + ";":     GOSUB IOOOTS 320 A\$ = "SDON;": GOSUB     IOOOTS  330 NEXT IX 340 A\$ = "EDITDONE;     LIMILINEON;     LIMITESTON;": GOSUB     IOOOTS </pre>	<p>Display the limit table header on the computer CRT.</p> <p>Repeat for each segment in the limit table.</p> <p>Load the data for the current segment, TABLE!(1 to 4, IX). Since LOADLIMIT is a subroutine, IX is used as a global variable.</p> <p>Clear the CRT lines being used for data entry.</p> <p>Determine if editing is initially desired.</p> <p>Repeat until all editing has been done.</p> <p>Get the number of the segment to be edited.</p> <p>Make sure the segment number is valid.</p> <p>Re-enter the segment data.</p> <p>Clear the CRT lines being used for data entry.</p> <p>Determine if more editing is desired.</p> <p>To begin sending the table to the analyzer, open the analyzer's limit line table for editing, and delete any existing segments.</p> <p>Loop for each segment.</p> <p>Add a segment, specifying its stimulus frequency value, upper limit value, lower limit value, and limit type. Then declare the current limit line segment done.</p> <p>Close the edit limit line table, display the limit lines on the analyzer, and activate limit testing.</p>
---	---

350 CALL IOLOCAL(ISC&): GOSUB ERRORTRAP	Return the network analyzer to local mode and perform error trapping.
360 END	End program execution.
370 ERRORTRAP:	Define a routine to trap errors.
380 IF PCIB.ERR <> NOERR THEN ERROR PCIB.BASERR	Perform error trapping.
390 RETURN	Return from the ERRORTRAP routine.
400 IOOOTS:	Define a routine to send a command string from the computer to the analyzer.
410 CALL IOOUTPUTS(VNA&, A\$, LEN(A\$)): GOSUB ERRORTRAP	Send the command string A\$ out to the analyzer and perform error trapping.
420 RETURN	Return from the IOOOTS routine.
430 LOADLIMIT:	Define a routine to read in all of one segment's data from the operator's input and load it into the data table on the computer.
440 GOSUB CLEARLINES	Clear the CRT lines being used for data entry.
450 LOCATE 1, 1: PRINT "SEGMENT: "; STR\$(I%);	
460 LOCATE 2, 1: PRINT "STIMULUS VALUE (MHz)?";	
470 LOCATE 3, 1: PRINT "UPPER LIMIT VALUE (dB)?";	
480 LOCATE 4, 1: PRINT "LOWER LIMIT VALUE (dB)?";	
490 LOCATE 1, 40: PRINT "LIMIT TYPE (1,2,3)?";	
500 LOCATE 2, 42: PRINT "1 = FLAT";	
510 LOCATE 3, 42: PRINT "2 = SLOPED";	
520 LOCATE 4, 42: PRINT "3 = SINGLE POINT";	Display the input labels.
530 IF ((TABLE!(1, I%) <> 0) OR (TABLE!(2, I%) <> 0) OR (TABLE!(3, I%) <> 0) OR (TABLE!(4, I%) <> 0)) THEN	If the segment contains valid data, display it at the entry locations.
540 LOCATE 2, 22: PRINT TABLE!(1, I%);	
550 LOCATE 3, 25: PRINT TABLE!(2, I%);	
560 LOCATE 4, 25: PRINT TABLE!(3, I%);	
570 LOCATE 1, 59: PRINT TABLE!(4, I%);	
580 END IF	
590 SAVE! = TABLE!(1, I%)	Save the stimulus frequency value of the current table entry.
600 LOCATE 2, 21: INPUT TABLE!(1, I%)	Read the stimulus frequency value of the segment.



610 IF TABLE!(1, I%) = 0 THEN TABLE!(1, I%) = SAVE!	If no value or 0 was entered, return the stimulus frequency to its previous value.
620 LOCATE 2, 22: PRINT SPACE\$(17)	Display the new stimulus frequency.
630 LOCATE 2, 22: PRINT TABLE!(1, I%);	Save the upper limit value of the current table entry.
640 SAVE! = TABLE!(2, I%)	Read the upper limit value of the segment.
650 LOCATE 3, 23: INPUT TABLE!(2, I%)	If no value or 0 was entered, return the upper limit to its previous value.
660 IF TABLE!(2, I%) = 0 THEN TABLE!(2, I%) = SAVE!	Display the new upper limit.
670 LOCATE 3, 24: PRINT SPACE\$(15): LOCATE 3, 25: PRINT TABLE!(2, I%);	Save the lower limit value of the current table entry.
680 SAVE! = TABLE!(3, I%)	Read the lower limit value of the segment.
690 LOCATE 4, 23: INPUT TABLE!(3, I%)	If no value or 0 was entered, return the lower limit to its previous value.
700 IF TABLE!(3, I%) = 0 THEN TABLE!(3, I%) = SAVE!	Display the new lower limit.
710 LOCATE 4, 24: PRINT SPACE\$(15): LOCATE 4, 25: PRINT TABLE!(3, I%)	Save the limit type integer code of the current table entry.
720 SAVE! = TABLE!(4, I%)	Set TABLE!(4, I%) for entry into the DO UNTIL loop.
730 TABLE!(4, I%) = 0	Repeat until a valid limit type integer code has been entered.
740 DO UNTIL ((TABLE!(4, I%) > 0) AND (TABLE!(4, I%) < 4))	Read the limit type integer code of the segment.
750 LOCATE 1, 58: INPUT TABLE!(4, I%)	If no value or 0 was entered and the previous value was valid, return the limit type integer code to that previous value.
760 IF (TABLE!(4, I%) = 0) THEN TABLE!(4, I%) = SAVE!	
770 LOOP	
780 LOCATE 1, 59: PRINT SPACE\$(28): LOCATE 1, 59: PRINT TABLE!(4, I%)	Display the new limit type integer code.
790 LOCATE I% + 6, 1: PRINT SPACE\$(80): LOCATE I% + 6, 1: PRINT TAB(5); I%; TAB(19); TABLE!(1, I%); TAB(36); TABLE!(2, I%); TAB(52); TABLE!(3, I%); TAB(68);	Display the new data in the table.
800 SELECT CASE TABLE!(4, I%)	Display the limit type corresponding to the limit type integer code in the table. Set the current LIMITTYPE\$ entry to the proper two-character code for transmission to the network analyzer.
CASE 1	A limit type integer code of 1 indicates "FLAT LINE".
810 PRINT "FLAT";	

820	LIMITTYPE\$(I%) = "FL"	
	CASE 2	A limit type integer code of 2 indicates "SLOPING LINE".
830	PRINT "SLOPED";	
840	LIMITTYPE\$(I%) = "SL"	
	CASE 3	A limit type integer code of 3 indicates "SINGLE POINT".
850	PRINT "SINGLE POINT";	
860	LIMITTYPE\$(I%) = "SP"	
870	END SELECT	
880	RETURN	Return from the LOADLIMIT routine.
890	CLEARLINES:	Define a routine to clear the CRT lines used for data entry.
900	FOR J% = 1 TO 4	Clear each line.
910	LOCATE J%, 1: PRINT SPACE\$(80)	
920	NEXT J%	
930	RETURN	Return from the CLEARLINES routine.

### Running the program

1. The computer clears the analyzer's limit line table. If this is not desired, remove the CLEL command from line 90.
2. Enter the number of segments and then the parameters of each segment as prompted.
3. Edit the computer's limit line table until it is satisfactory. Pressing <ENTER> at a prompt during editing leaves the parameter at its current value.
4. The computer sends the completed limit line table out to the analyzer, which orders the segments, activates limit testing, and displays the limit lines.

## Example 5B: PASS/FAIL tests

The following program illustrates how to perform limit testing using the limit/search fail bits in Event Status Register B. The requirement that several sweeps in a row must pass is used in order to ensure that the limit test pass was not extraneous due to the device settling or the operator tuning during the sweep.

The program assumes that an appropriate calibration has been performed, that limit lines have been defined, and that limit testing is on prior to running the program.

This program is stored on the Example Programs disk as **IPG5B.BAS**.

10	REM \$INCLUDE: 'QBSETUP'	Call the QuickBASIC initialization file QBSETUP.
20	CLS	Clear the computer CRT.
30	ISC& = 7	Assign the interface select code to a variable.
40	VNA& = 716	Assign the analyzer's address to a variable.
50	CALL IOTIMEOUT(ISC&, 10!): GOSUB ERRORTRAP	Define a system time-out of ten seconds and perform error trapping.
60	CALL IOABORT(ISC&): GOSUB ERRORTRAP	Abort any HP-IB transfers and perform error trapping.
70	CALL IOCLEAR(ISC&): GOSUB ERRORTRAP	Clear the analyzer's HP-IB interface and perform error trapping.
80	CALL IOEOD(ISC&, 0): GOSUB ERRORTRAP	Disable the End-Or-Identify mode for transferring data and perform error trapping.
90	INPUT "NUMBER OF CONSECUTIVE PASSED SWEEPS FOR QUALIFICATION? ", QUAL%	Enter the number of sweeps that must pass before the device is considered to have passed the limit test.
100	STARTTEST: PASSES% = 0	Initialize the counter holding the number of sweeps that have passed the limit test.
110	CLS : PRINT "TUNE DEVICE"	Display instructions on the computer CRT.
120	CONTINUE: A\$ = "OPC?"; SING;": GOSUB IOOUTS	Sweep once and thus perform a limit test.
130	CALL IOENTER(VNA&, REPLY!): GOSUB ERRORTRAP	Wait for the end of the sweep.
140	A\$ = "ESB?";": GOSUB IOOUTS	Request the Event Status Register B value from the analyzer.
150	CALL IOENTER(VNA&, ESTAT!): GOSUB ERRORTRAP	Receive the Event Status Register B value from the analyzer in order to check the fail bit.
160	IF ((ESTAT! MOD 32) > 15) THEN	Check if bit 4, the channel 1 limit fail bit, is set, indicating that the device failed the current sweep.
170	IF (PASSES% <> 0) THEN SOUND 300, 5	If sweeps have been passing, audibly warn the operator that the device is now failing.
180	GOTO STARTTEST	Restart the test sequence.
190	END IF	
200	SOUND 1000, 1	Indicate audibly that the device passed the current sweep.
210	PASSES% = PASSES% + 1	Increment the sweeps passed counter.
220	IF PASSES% = 1 THEN	The device just passed its first sweep, encourage the operator to stop tuning the device.
230	CLS : PRINT "STOP TUNING"	
240	END IF	

250 IF PASSES% < QUAL% THEN GOTO CONTINUE	Loop until enough consecutive sweeps have passed that the device is considered to have passed the limit test.
260 CLS : PRINT "DEVICE PASSED"	Display program progress on the computer CRT.
270 FOR INDEX% = 1 TO 5	Indicate audibly that the device has passed the limit test.
280 SOUND 500, 1	
290 SOUND 1000, 1	
300 NEXT INDEX%	
310 SOUND 2000, 1	
320 PRINT "PRESS <ENTER> TO TEST NEXT DEVICE, <ESC> TO END."	Display instructions on the computer CRT.
330 CHAR\$ = CHR\$(0)	Initialize CHAR\$ for entry into the DO UNTIL loop.
340 DO UNTIL ((CHAR\$ = CHR\$(13)) OR (CHAR\$ = CHR\$(27)))	Wait until a valid key (<ENTER> or <ESC>) is pressed.
350 CHAR\$ = INKEY\$	
360 LOOP	
370 IF (CHAR\$ = CHR\$(13)) THEN	If <ENTER> was pressed, return to the beginning of the test cycle to test the next device.
380 GOTO STARTTEST	
390 END IF	
400 CALL IOLOCAL(ISC&): GOSUB ERRORTRAP	Return the network analyzer to local mode and perform error trapping.
410 END	End program execution.
420 ERRORTRAP:	Define a routine to trap errors.
430 IF PCIB.ERR <> NOERR THEN ERROR PCIB.BASERR	Perform error trapping.
440 RETURN	Return from the ERRORTRAP routine.
450 IOOUTS:	Define a routine to send a command string from the computer to the analyzer.
460 CALL IOOUTPUTS(VNA&, A\$, LEN(A\$)): GOSUB ERRORTRAP	Send the command string A\$ out to the analyzer and perform error trapping.
470 RETURN	Return from the IOOUTS routine.

### Running the program

1. Set up a limit table on channel 1 for a specific device either manually or using Example 5A: *Limit line setup*.
2. Run the program. Specify the number of sweeps that must pass for qualification. For very slow sweeps, as few as two sweeps is appropriate. For very fast sweeps, as many as six or more sweeps may be needed.
3. Connect the filter. The computer beeps to indicate the test status.
4. When enough consecutive sweeps pass, the computer warbles and requests a new device.

## Storing/recalling instrument states

It is possible to store and recall entire instrument states over HP-IB using the commands to read the learn string and the calibration data out of the analyzer. The learn string is up to 3000 bytes long and is in form 1, instrument internal binary. It includes all front panel settings, the list frequency table, and the limit table for each channel. It is read out with OUTPLEAS and sent back with INPULEAS.

Although the learn string contains the identity of the current active calibration, it does not contain the calibration data. Therefore, in order to get the entire instrument state, it is necessary to read out the learn string and the calibration data. This calibration data is stored inside the network analyzer in up to twelve calibration coefficient arrays. Each array is a specific error coefficient and is stored and transmitted as a data array of which each point is specified as a real/imaginary pair of real numbers. The number of points in the array is the same as the number of points in the sweep. For more information about which calibration coefficients correspond to which calibration types, see the section entitled *Calibration Arrays* in the *HP-IB Quick Reference*.

The computer can read out the error coefficient arrays using the commands OUTPCALC01, OUTPCALC02, ... OUTPCALC12. Each calibration type uses only as many arrays as are needed, starting with array 1. Hence, it is necessary to know the calibration type and therefore the number of arrays before trying to read them out. Although the calibration type is in the learn string, it is difficult to extract. Instead, it can be determined if a calibration type is active by sending the mnemonic of the type in question followed by a question mark (CAL IRESP?). The analyzer will then respond with 1 if that type is active and 0 if it is not.

Calibration data can also be sent from the computer to the analyzer. The calibration type mnemonic must be sent first to prepare the analyzer. Then the calibration coefficient arrays can be transferred using the INPUCALCnn commands. Once all the coefficients are in the analyzer, the command sequence SAVC; CONT will create a calibration set and put the analyzer in continuous sweep trigger mode, thereby activating the calibration.

### Example 6A: Learn string

The following program makes use of the learn string to transfer the instrument state between the analyzer and the computer. It demonstrates the use of the commands OUTPLEAS and INPULEAS. Note that character matching must be disabled by calling the HP-IB Command Library routine IDMATCH before the learn string is read in by the routine IOENTERS. This prevents the computer from terminating on a linefeed when the string is read because the learn string may contain linefeeds as part of its information.

This example program is stored on the Example Programs disk as **IPG6A.BAS**.

10	REM \$INCLUDE: 'QBSETUP'	Call the QuickBASIC initialization file QBSETUP.
20	CLS	Clear the computer CRT.
30	ISC& = 7	Assign the interface select code to a variable.
40	VNA& = 716	Assign the analyzer's address to a variable.
50	CALL IOTIMEOUT(ISC&, 10!): GOSUB ERRORTRAP	Define a system time-out of ten seconds and perform error trapping.
60	CALL IOABORT(ISC&): GOSUB ERRORTRAP	Abort any HP-IB transfers and perform error trapping.
70	CALL IOCLEAR(ISC&): GOSUB ERRORTRAP	Clear the analyzer's HP-IB interface and perform error trapping.
80	MATCH\$ = CHR\$(10)	Define the match character as the linefeed.
90	ENABLE% = 1: DISABLE% = 0	Initialize flag values to enable and disable character matching.
100	CALL IDMATCH(ISC&, MATCH\$, DISABLE%): GOSUB ERRORTRAP	Disable character matching for the current match character, the linefeed. This prevents termination on a linefeed when a string is read since the linefeed could actually be part of the learn string information.

110 A\$ = "OUTPLEAS;": GOSUB IOOOTS	Request the learn string from the analyzer.
120 MAX% = 3000	Set the maximum number of characters to read in.
130 LEARNSTRING\$ = SPACE\$(MAX%)	Set aside space to receive the learn string.
140 ACTUAL% = 0	Initialize the actual number of characters read in. This variable is given a value by IDENTERS.
150 CALL IDENTERS(VNA&, LEARNSTRING\$, MAX%, ACTUAL%): GOSUB ERRORTRAP	Receive the learn string from the analyzer.
160 LEARNSTRING\$ = LEFT\$(LEARNSTRING\$, ACTUAL%)	Redefine the learn string to contain only the information read in from the analyzer.
170 CALL IDMATCH(ISC&, MATCH\$, ENABLE%): GOSUB ERRORTRAP	Enable character matching. This results in termination on a linefeed when a string is read.
180 CALL IDLOCAL(ISC&): GOSUB ERRORTRAP	Put the analyzer in local mode.
190 PRINT "CHANGE STATE AND PRESS <ENTER>"	
200 DO UNTIL INKEY\$ = CHR\$(13): LOOP	Allow the operator to connect a new analyzer or to modify the state of the present analyzer from the front panel.
210 A\$ = "INPULEAS" + LEARNSTRING\$ + ";": GOSUB IOOOTS	Restore the state defined in the learn string to the analyzer.
220 PRINT "INITIAL INSTRUMENT STATE RESTORED."	Display program progress on the computer CRT.
230 CALL IDLOCAL(ISC&): GOSUB ERRORTRAP	Return the network analyzer to local mode and perform error trapping.
240 END	End program execution.
250 ERRORTRAP:	Define a routine to trap errors.
260 IF PCIB.ERR <> NOERR THEN ERROR PCIB.BASERR	Perform error trapping.
270 RETURN	Return from the ERRORTRAP routine.
280 IOOOTS:	Define a routine to send a command string from the computer to the analyzer.
290 CALL IOOUTPUTS(VNA&, A\$, LEN(A\$)): GOSUB ERRORTRAP	Send the command string A\$ out to the analyzer and perform error trapping.
300 RETURN	Return from the IOOOTS routine.

### Running the program

1. The computer reads the learn string in from the analyzer, thereby storing its state.
2. Change the state of the analyzer from its front panel as prompted.
3. The computer sends the learn string back to the analyzer, thereby restoring it to its original state.

## Example 6B: Reading calibration data

The following program illustrates how to determine which calibration is active, how to read measurement calibration data out of the network analyzer, and how to put it back into the instrument.

The two-dimensional calibration coefficient arrays are transferred in *form 5*, PC-DOS 32-bit floating point format. They are stored in one three-dimensional array from which they can be examined, modified, stored, and put back into the instrument. If the data is only to be stored and put back, it is most efficient to read it in *form 1*, instrument internal binary format.

This example program is stored on the Example Programs disk as **IPG6B.BAS**.

10	REM \$INCLUDE: 'QBSETUP'	Call the QuickBASIC initialization file QBSETUP.
20	CLS	Clear the computer CRT.
30	ISC& = 7	Assign the interface select code to a variable.
40	VNA& = 716	Assign the analyzer's address to a variable.
50	CALL IOTIMEOUT(ISC&, 10!): GOSUB ERRORTRAP	Define a system time-out and perform error trapping.
60	CALL IOABORT(ISC&): GOSUB ERRORTRAP	Abort any HP-IB transfers and perform error trapping.
70	CALL IOCLEAR(ISC&): GOSUB ERRORTRAP	Clear the analyzer's HP-IB interface and perform error trapping.
80	CALL IOEDI(ISC&, 0): GOSUB ERRORTRAP	Disable the End-Or-Identify mode for transferring data and perform error trapping.
90	DIM CALTYPE\$(1 TO 6), NUMBER%(1 TO 6)	Set up parallel arrays of possible calibrations and the number of arrays associated with each calibration.
100	CALTYPE\$(1) = "CALIRESP": NUMBER%(1) = 1	
110	CALTYPE\$(2) = "CALIRAI": NUMBER%(2) = 2	
120	CALTYPE\$(3) = "CALIS111": NUMBER%(3) = 3	
130	CALTYPE\$(4) = "CALIS221": NUMBER%(4) = 3	
140	CALTYPE\$(5) = "CALIFUL2": NUMBER%(5) = 12	
150	CALTYPE\$(6) = "NOOP": NUMBER%(6) = 0	
160	LOCATE 5, 25: PRINT "CALIBRATION NUMBER OF"	
170	LOCATE 6, 25: PRINT " TYPE ARRAYS"	Display the calibration table heading.
180	FOR I% = 1 TO 6	Display a table of possible calibrations on the computer CRT.
190	LOCATE 7 + I%, 18: PRINT USING "##"; I%;	
200	PRINT ". "; TAB(27); CALTYPE\$(I%); TAB(45);	
210	PRINT USING "##"; NUMBER%(I%)	
220	NEXT I%	
230	ACTIVE! = 0	Initialize ACTIVE! for entry into the DO UNTIL loop.

240 DO UNTIL ACTIVE!	Repeat until the active calibration type is selected by the user.
250 INDEX% = 0	Initialize INDEX% for entry into the DO UNTIL loop.
260 DO UNTIL ((INDEX% > 0) AND (INDEX% < 7))	Get a valid calibration type selection from the user.
270 LOCATE 15, 25: INPUT "ENTER SELECTION: ", INDEX%	
280 LOOP	
290 IF (NUMBER%(INDEX%) = 0) THEN	If no calibration was active, clear the computer CRT and go to the end of the program.
300 CLS : GOTO FINISH	
310 END IF	
320 A\$ = CALTYPE\$(INDEX%) + "?;": GOSUB I00UTS	Ask the network analyzer if the user-chosen calibration is active.
330 CALL IDENTER(VNA&, ACTIVE!): GOSUB ERRORTRAP	Get the response from the analyzer.
340 LOOP	
350 CLS	Clear the computer CRT.
360 PRINT "CALIBRATION TYPE: "; CALTYPE\$(INDEX%)	Confirm that the analyzer's active calibration has been found by displaying it and its corresponding number of arrays on the computer CRT.
370 PRINT "NUMBER OF ARRAYS: "; NUMBER%(INDEX%)	
380 A\$ = "FORM5; POIN?;": GOSUB I00UTS	Set data to be transferred in form 5, PC-DOS floating point and request the number of points from the analyzer.
390 CALL IDENTER(VNA&, POINTS!): GOSUB ERRORTRAP	Receive the number of points from the analyzer.
400 POINTS% = INT(POINTS!)	Convert the number of points to an integer.
410 DIM CAL!(1 TO 2, 0 TO POINTS%, 1 TO NUMBER%(INDEX%))	Allocate space for a three-dimensional array to hold all the calibration coefficients. Think of CAL! as a data structure with a two-dimensional array for each of the calibration type's corresponding arrays. These two-dimensional arrays are read in one at a time, and each is preceded by a four-byte header. Space is allocated for these headers by extending CAL!'s second dimension by one and thus adding two real numbers (eight bytes) to the beginning of each two-dimensional array.
420 DIM DIGIT\$(1 TO NUMBER%(INDEX%))	Dimension an array to hold two-digit integers from 1 to the number of arrays, each integer with a leading zero if necessary. These are used with OUTPCALC and INPUCALC commands.
430 LOCATE 1, 41: PRINT "ARRAYS RECEIVED: "	Display a heading for program progress information.
440 MAX% = 4 * 2 * POINTS% + 4	The maximum number of bytes to read in for each two-dimensional array is two four-byte numbers per point with POINTS% points plus a four-byte header.
450 FLAG% = 1	Set FLAG% for no swapping of bytes.
460 FOR I% = 1 TO NUMBER%(INDEX%)	Read in each of the two-dimensional arrays making up CAL! one at a time.



470	ACTUAL% = 0	Initialize or re-initialize the actual number of bytes read in.
480	DIGIT\$(I%) = STR\$(I%)	Create the current two-digit number string corresponding to I%.
490	IF (LEN(DIGIT\$(I%)) = 2) THEN	Since strings corresponding to positive numbers are preceded by a space, one-digit numbers are two characters long. These must be converted to 0 followed by the one digit in order to be the required two digits long.
500	DIGIT\$(I%) = "0" + RIGHT\$(DIGIT\$(I%), 1)	
510	ELSE	
520	DIGIT\$(I%) = RIGHT\$(DIGIT\$(I%), 2)	The number is already two digits long, so simply remove the preceding space.
530	END IF	
540	A\$ = "OUTPCALC" + DIGIT\$(I%) + ";": GOSUB IDOUTS	Request the current two-dimensional calibration coefficient array from the analyzer.
550	CALL IDENTERB(VNA%, SEG CAL!(2, 0, I%), MAX%, ACTUAL%, FLAG%): GOSUB ERRORTRAP	Read in the current two-dimensional array, specifying the beginning array address as one real number (four bytes) before the desired destination of the true data in order to read in the header.
560	LOCATE 1, 60: PRINT I%	Display program progress on the computer CRT.
570	NEXT I%	
580	LOCATE 4, 1: PRINT "PRESS <ENTER> TO RE-TRANSMIT CALIBRATION."	Display instructions on the computer CRT.
590	DO UNTIL INKEY\$ = CHR\$(13): LOOP	Wait for the operator to continue.
600	LOCATE 4, 1: PRINT SPACE\$(80)	Clear the instruction display line on the computer CRT.
610	A\$ = CALTYPE\$(INDEX%) + ";": GOSUB IDOUTS	Prepare the analyzer to receive the correct calibration type from the computer.
620	LOCATE 2, 41: PRINT "ARRAYS TRANSMITTED: ";	Display a heading for program progress information.
630	FOR I% = 1 TO NUMBER%(INDEX%)	Send out each of the two-dimensional arrays making up CAL! separately.
640	A\$ = "INPUCALC" + DIGIT\$(I%) + ";": GOSUB IDOUTS	Prepare the analyzer to receive the current two-dimensional calibration coefficient array.
650	CALL IDOUTPUTB(VNA%, SEG CAL!(2, 0, I%), MAX%, FLAG%)	Send the current two-dimensional calibration coefficient array to the analyzer.
660	LOCATE 2, 60: PRINT I%	Display program progress on the computer CRT.
670	NEXT I%	
680	A\$ = "SAVC;": GOSUB IDOUTS	Create a cal set using the current calibration data.
690	A\$ = "CONT;": GOSUB IDOUTS	Trigger a sweep so that the calibration becomes active.
700	FINISH: LOCATE 4, 1: PRINT "DONE"	Display program progress on the computer CRT.

710 CALL IDLOCAL(ISC&): GOSUB ERRORTRAP	Return the network analyzer to local mode and perform error trapping.
720 END	End program execution.
730 ERRORTRAP:	Define a routine to trap errors.
740 IF PCIB.ERR <> NOERR THEN ERROR PCIB.BASERR	Perform error trapping.
750 RETURN	Return from the ERRORTRAP routine.
760 IDOUTS:	Define a routine to send a command string from the computer to the analyzer.
770 CALL IDOUTPUTS(VNA&, A\$, LEN(A\$)): GOSUB ERRORTRAP	Send the command string A\$ out to the analyzer and perform error trapping.
780 RETURN	Return from the IDOUTS routine.

### Running the program

1. When the computer displays the calibration type table, enter the number corresponding to the active calibration on the analyzer. Before continuing, the computer ensures that the correct type was chosen by questioning the analyzer.
2. The computer reads the up to twelve calibration coefficient arrays from the network analyzer one at a time into one three-dimensional array.
3. Press <ENTER> on the computer CRT as prompted.
4. The computer sends the up to twelve calibration coefficient arrays back to the network analyzer one at a time.

# Miscellaneous Programming Examples

## Example 7: Interrupt generation

The following program illustrates how to use the HP-IB Command Library routine IOPEN and QuickBASIC's PEN statements to generate interrupts. A call to IOPEN:

```
CALL IOPEN(ISC&, 0): GOSUB ERRORTRAP
```

will enable a Service Request (SRQ) to generate an interrupt that can be detected by QuickBASIC's PEN statements. Through these statements, QuickBASIC has the ability to enable (PEN ON) and disable (PEN OFF) HP-IB interrupts and execute an interrupt handling routine every time one occurs (ON PEN GOSUB xxxx).

In order for the analyzer to generate an SRQ when a specific event occurs, both the desired Event Status Register bit and the desired status byte bit must be enabled. The status reporting system can be set up using HP-IB commands, and it must be reset every time the status is cleared (CLES). For example, ESE 64; SRE 32 enables the User Request bit (6;  $64 = 2^6$ ) of the Event Status Register and the Event Status Register summary bit (5;  $32 = 2^5$ ) of the status byte (refer ahead to Figure A.1 on page 65). This means that when the User Request bit is set, the Event Status Register summary bit in the status byte is set. Likewise when the Event Status Register summary bit in the status byte is set, an SRQ is generated. With this status reporting system, a key press will generate an SRQ. By then using the above described PEN statements, an SRQ can be made to generate an interrupt, which will cause a special interrupt handling routine to be executed.

The following program uses the HP-IB command WRSK<sub>n</sub> to re-label the softkeys. The interrupt generation system is then set up so that when a key is pressed, the computer processes the generated interrupt by identifying which key was pressed. If full use of this method is made, an automatic system would no longer require a computer keyboard and would instead be as easy to use as a manual instrument.

This example program is stored on the Example Programs disk as IPG7.BAS.

```
10 REM $INCLUDE: 'QBSETUP'      Call the QuickBASIC initialization file QBSETUP.
20 CLS                          Clear the computer CRT.
30 ISC& = 7                     Assign the interface select code to a variable.
40 VNA& = 716                  Assign the analyzer's address to a variable.
50 CALL IOTIMEOUT(ISC&, 10!):  Define a system time-out of ten seconds and
   GOSUB ERRORTRAP              perform error trapping.
60 CALL IOABORT(ISC&): GOSUB   Abort any HP-IB transfers and perform error
   ERRORTRAP                    trapping.
70 CALL IOCLEAR(ISC&): GOSUB   Clear the analyzer's HP-IB interface and perform
   ERRORTRAP                    error trapping.
80 CALL IOEOI(ISC&, 0): GOSUB  Disable the End-Or-Identify mode for transferring
   ERRORTRAP                    data and perform error trapping.
90 A$ = "PRES;": GOSUB         Preset the network analyzer.
   IOOUTS
100 A$ = "CLES; ESE64;        Clear the status byte and set the status reporting
   SRE32;": GOSUB IOOUTS        system to the following:
                                  1) Bit 6, User Request, of the Event Status
                                  Register is summarized by bit 5 of the status
                                  byte. This allows a key press to be detected by
                                  a serial poll.
                                  2) Bit 5 of the status byte, the Event Status
                                  Register, is enabled. This allows the Event
                                  Status Register to generate service requests.
110 A$ = "MENUMRKF;": GOSUB   Activate a menu that uses all of the softkeys in
   IOOUTS                        order to ensure that each softkey is active and
                                  may be written to.
120 A$ = "MENUOFF;": GOSUB    Turn the built-in softkey menu off so that the
   IOOUTS                        softkeys may be labeled by the computer.
```

130 A\$ = "WRSK1 " + CHR\$(34) + "CAL #1" + CHR\$(34) + ";": GOSUB IOOOTS	Label the softkeys. The label must be preceded and followed by double quotes. To put double quotes within a string in QuickBASIC, use CHR\$(34).
140 A\$ = "WRSK2 " + CHR\$(34) + "TEST #1" + CHR\$(34) + ";": GOSUB IOOOTS	
150 A\$ = "WRSK3 " + CHR\$(34) + "CAL #2" + CHR\$(34) + ";": GOSUB IOOOTS	
160 A\$ = "WRSK4 " + CHR\$(34) + "TEST #2" + CHR\$(34) + ";": GOSUB IOOOTS	
170 A\$ = "WRSK8 " + CHR\$(34) + "ABORT" + CHR\$(34) + ";": GOSUB IOOOTS	
180 PRINT "SOFTKEYS LOADED"	Display program progress on the computer CRT.
190 PEN OFF	Disable HP-IB interrupts.
200 ON PEN GOSUB GETSRQ	Set up the interrupt system so that whenever an HP-IB interrupt occurs, a routine that gets a service request will be executed.
210 PEN ON	Enable HP-IB interrupts.
220 CALL IOPEN(ISC&, 0): GOSUB ERRORTRAP	Let an SRQ generate an interrupt.
230 WAITSRQ:	Continue to let key presses generate interrupts until the eighth softkey, labeled <ABORT>, is pressed.
240 IF KEYCODE% <> 10 THEN GOTO WAITSRQ	
250 PEN OFF	Disable HP-IB interrupts.
260 A\$ = "MENUON;": GOSUB IOOOTS	Turn the softkey menu back on.
270 CALL IOLOCAL(ISC&): GOSUB ERRORTRAP	Return the network analyzer to local mode and perform error trapping.
280 END	End program execution.
290 ERRORTRAP:	Define a routine to trap errors.
300 IF PCIB.ERR <> NDERR THEN ERROR PCIB.BASERR	Perform error trapping.
310 RETURN	Return from the ERRORTRAP routine.
320 IOOOTS:	Define a routine to send a command string from the computer to the analyzer.
330 CALL IOOUTPUTS(VNA&, A\$, LEN(A\$)): GOSUB ERRORTRAP	Send the command string A\$ out to the analyzer and perform error trapping.
340 RETURN	Return from the IOOOTS routine.
350 GETSRQ:	Define a routine to get a service request.
360 CALL IOS POLL(VNA&, STAT%): GOSUB ERRORTRAP	Perform a serial poll to read in the status byte and thereby clear it.
370. A\$ = "CLES; ESE64; SRE32;": GOSUB IOOOTS	Ensure that the status byte was cleared and that the proper status reporting system is in operation.
380 A\$ = "OUTPKEY;": GOSUB IOOOTS	Request the code of the last analyzer key pressed from the analyzer.
390 CALL IOENTER(VNA&, KEYCODE!): GOSUB ERRORTRAP	Receive the key code from the analyzer.

400	KEYCODE% = INT(KEYCODE!)	Convert the key code to an integer.
410	SELECT CASE KEYCODE%:	
	CASE 60	The first softkey is labeled CAL #1.
420	CLS : LOCATE 1, 1: PRINT "CALIBRATION #1"	
	CASE 61	The second softkey is labeled TEST #1.
430	CLS : LOCATE 1, 1: PRINT "TEST #1"	
	CASE 56	The third softkey is labeled CAL #2.
440	CLS : LOCATE 1, 1: PRINT "CALIBRATION #2"	
	CASE 59	The fourth softkey is labeled TEST #2.
450	CLS : LOCATE 1, 1: PRINT "TEST #2"	
	CASE 10	The eighth softkey is labeled ABORT.
460	CLS : LOCATE 1, 1: PRINT "ABORT"	
	CASE ELSE	No other keys are defined.
470	CLS : LOCATE 1, 1: PRINT "***UNDEFINED***"	
480	END SELECT	
490	RETURN	Return from the GETSRQ routine.

### Running the program

1. The computer presets the network analyzer, relabels the softkeys, and sets up the desired network analyzer status reporting and interrupt generation systems.
2. When a key is pressed, an interrupt is generated and the interrupt handling routine, which displays the identity of the key pressed on the computer, is executed.
3. Press the network analyzer softkey labeled ABORT to end the program.

## Example 8: User interface

The following example program illustrates how to create a custom user interface involving only the front panel keys and the display of the network analyzer. Graphics can be drawn by sending HP-GL (Hewlett-Packard Graphics Language) commands to the network analyzer display. See the section entitled *Display Graphics* in the *HP-IB Quick Reference* for a list of accepted HP-GL commands and their functions.

It is possible to customize a user interface by taking over the network analyzer's front panel keys. The User Request bit in the Event Status Register is set whenever a front panel key is pressed or the knob is turned regardless of the current mode (local or remote) of the analyzer. Each key has its own number, as shown in Figure E.4, *Front Panel Keycodes*, of the *HP-IB Quick Reference*. The number of the key last pressed can be read with `OUTPKEY?` or `KOR?`. With `OUTPKEY?`, a knob turn is always reported as negative one. With `KOR?`, a knob turn is reported as a negative number encoded with the number of counts turned. There are 120 counts per knob rotation. Clockwise rotations are reported as numbers from  $-1$  to  $-64$ ,  $-1$  being a very small rotation. Counter-clockwise rotations are reported as numbers from  $-32767$  to  $-32701$ ,  $-32767$  being a very small rotation. Hence, clockwise rotations do not need any decoding at all; counter-clockwise rotations can be decoded by adding 32768.

This example uses the knob and the up and down keys on the network analyzer to adjust the size and position of a grid on the display. Pressing `[ENTRY OFF]` on the network analyzer selects the current size or position and continues the program.

This example program is stored on the Example Programs disk as `IPG8.BAS`.

10	REM \$INCLUDE: 'QBSETUP'	Call the QuickBASIC initialization file QBSETUP.
20	CLS	Clear the computer CRT.
30	ISC& = 7	Assign the interface select code to a variable.
40	VNA& = 716	Assign the analyzer's address to a variable.
50	DISPLAY& = 717	Assign the analyzer display's address to a variable.
60	CALL IDTIMEOUT(ISC&, 10!): GOSUB ERRORTRAP	Define a system time-out of ten seconds and perform error trapping.
70	CALL IDABORT(ISC&): GOSUB ERRORTRAP	Abort any HP-IB transfers and perform error trapping.
80	CALL IDCLEAR(ISC&): GOSUB ERRORTRAP	Clear the analyzer's HP-IB interface and perform error trapping.
90	CALL IDEOI(ISC&, 0): GOSUB ERRORTRAP	Disable the End-Or-Identify mode for transferring data and perform error trapping.
100	ADDRESS& = VNA&: A\$ = "AUTO; CLES; ESE64; POIN?"; GOSUB IDOOTS	Prepare the analyzer by scaling the trace for plotting, clearing the status byte, and setting up the status reporting system so that bit 6, User Request, of the Event Status Register is summarized by bit 5 of the status byte (allowing a key press to be detected by a serial poll). Then request the number of points from the analyzer.
110	CALL IOENTER(VNA&, POINTS!): GOSUB ERRORTRAP	Receive the number of points from the analyzer.
120	POINTS% = INT(POINTS!)	Convert the number of points to an integer.
130	DIM DAT!(1 TO 2, 0 TO POINTS%)	Prepare an array to receive the data.
140	ADDRESS& = VNA&: A\$ = "SING; FORM2; OUTPFORM"; GOSUB IDOOTS	Sweep once and then hold. Tell the analyzer to send out formatted data in form 2, IEEE 32-bit floating point.

150 MAX% = POINTS% * 2 * 4 + 4	The maximum number of bytes to be read in is two 4-byte real numbers per point with POINTS% points plus the four-byte (two-integer) header.
160 ACTUAL% = 0	Initialize the actual number of bytes read in. This variable is given a value by IOENTERB.
170 FLAG% = 4	Swap every four bytes.
180 CALL IOENTERB(VNA%, SEG DAT!(2, 0), MAX%, ACTUAL%, FLAG%): GOSUB ERRORTRAP	Read in the data from the analyzer.
190 ADDRESS% = VNA%: A\$ = "SCAL?;": GOSUB IOOUTS	Request the scale factor from the network analyzer.
200 CALL IOENTER(VNA%, SCAL!): GOSUB ERRORTRAP	Receive the scale factor.
210 ADDRESS% = VNA%: A\$ = "REFP?;": GOSUB IOOUTS	Request the reference position from the network analyzer.
220 CALL IOENTER(VNA%, REFP!): GOSUB ERRORTRAP	Receive the reference position.
230 ADDRESS% = VNA%: A\$ = "REFV?;": GOSUB IOOUTS	Request the value at the reference position from the network analyzer.
240 CALL IOENTER(VNA%, REFV!): GOSUB ERRORTRAP	Receive the value at the reference position.
250 XMAX% = 5850: YMAX% = 4094	Set maximum limits for x and y values. These are the corner coordinate values given in the section entitled <i>Display Graphics</i> in the <i>HP-IB Quick Reference</i> ; YMAX% is rounded to an even number for simplicity.
260 XCENTER% = XMAX% / 2: YCENTER% = YMAX% / 2	Initialize the center values for x and y to reasonable values.
270 SIZE% = 750	Initialize the size of the square to a reasonable value.
280 ADDRESS% = DISPLAY%: A\$ = "CS; SP2;": GOSUB IOOUTS	Turn off the analyzer's measurement display and set its color to that of channel 1 memory using display graphics commands.
290 PRINT "ADJUST SIZE OF VIEWPORT. PRESS [ENTRY OFF] TO CONTINUE."	Display instructions on the computer CRT.
300 KEYCODE% = 0: OLDSIZE% = 0	Initialize KEYCODE for entry into the DO UNTIL loop, and initialize OLDSIZE% for entry into the IF...THEN loop. This ensures that the square is drawn the first time.
310 DO UNTIL (KEYCODE% = 34)	Continue to adjust the size of the square until [ENTRY OFF] is pressed on the analyzer.
320 IF (SIZE% <> OLDSIZE%) THEN	If the size of the square has been changed, redraw it.
330 GOSUB DRAWSQUARE	
340 OLDSIZE% = SIZE%	Keep track of the previous size setting.
350 END IF	If the size has not changed, the square does not need to be redrawn.
360 GOSUB GETKEY	Wait for an analyzer key to be pressed, and get its code.
370 IF KEYCODE% < 0 THEN	KEYCODE% indicates a knob count if it is negative.

380	IF (KEYCODE% < -64) THEN KEYCODE% = KEYCODE% + 32768	If the knob count is less than -64, add 32768 (2 <sup>15</sup> ) to recover it. If the knob count is greater than -64, no decoding is needed.
390	SIZE% = SIZE% - KEYCODE% * 15	Adjust the size of the square according to the knob count, multiplying the knob count to make the size change significant.
400	ELSE	KEYCODE% indicates a key press if it is positive.
410	IF (KEYCODE% <> 34) THEN	If the key press was not [ENTRY OFF], it was not a valid key, so display an appropriate message on the computer CRT.
420	PRINT "ONLY <ENTRY OFF> AND KNOB TURNING ARE VALID ENTRIES"	
430	END IF	
440	END IF	
450	IF (SIZE% < 100) THEN	Enforce the minimum size limit.
460	SIZE% = 100	
470	ELSE	
480	IF (SIZE% > ((YMAX% / 2) - 2)) THEN	Enforce the maximum size limit.
490	SIZE% = ((YMAX% / 2) - 2)	
500	END IF	
510	END IF	
520	LOOP	The size of the square has now been adjusted.
530	CLS	Clear the computer CRT.
540	ADDRESS% = DISPLAY%: A\$ = "SP4;": GOSUB IDOUTS	Set the analyzer display's color to that of channel 2 memory by using a display graphics command.
550	PRINT "ADJUST POSITION OF VIEWPORT. PRESS <ENTRY OFF> TO STOP."	Display operator instructions on the computer CRT.
560	KEYCODE% = 0: OLDXCENTER% = 0: OLDYCENTER% = 0	Initialize variables for entry into the DO UNTIL and IF... THEN loops. This ensures that the square is drawn the first time.
570	DO UNTIL (KEYCODE% = 34)	Continue to adjust the position of the square until [ENTRY OFF] is pressed on the analyzer.
580	IF ((OLDXCENTER% <> XCENTER%) OR (OLDYCENTER% <> YCENTER%)) THEN	If the position of the square has been changed, redraw it.
590	GOSUB DRAWSQUARE	
600	OLDXCENTER% = XCENTER%: OLDYCENTER% = YCENTER%	Keep track of the previous center settings.
610	END IF	If the position has not changed, the square does not need to be redrawn.
620	GOSUB GETKEY	Wait for an analyzer key to be pressed, and get its code.
630	SELECT CASE KEYCODE% CASE 26	Reposition the square according to KEYCODE%. [UP ARROW] was pressed.



640	YCENTER% = YCENTER% + 150	Move the square up.
	CASE 18	[DOWN ARROW] was pressed.
650	YCENTER% = YCENTER% - 150	Move the square down.
	CASE IS < 0	The knob was turned.
660	IF (KEYCODE% < -64) THEN	Recover the knob count, if necessary.
	KEYCODE% = KEYCODE% +	
	32768	
670	XCENTER% = XCENTER% -	Move the square to the left or to the right
	KEYCODE% * 20	according to the knob count, multiplying it to
		make the position change significant.
	CASE 34	[ENTRY OFF] was pressed, so accept the key as
		valid and do not move the square.
	CASE ELSE	An invalid key was pressed.
680	PRINT "ONLY [UP ARROW],	Display an appropriate message on the computer
	[DOWN ARROW], [ENTRY	CRT.
	OFF], AND KNOB TURNING	
	ARE VALID"	
690	END SELECT	
700	IF XCENTER% > (XMAX% -	Enforce the right side limit.
	SIZE% - 2) THEN	
710	XCENTER% = (XMAX% - SIZE%	
	- 2)	
720	ELSE	
730	IF XCENTER% < (SIZE% + 2)	Enforce the left side limit.
	THEN	
740	XCENTER% = (SIZE% + 2)	
750	ELSE	
760	IF YCENTER% > (YMAX% -	Enforce the top side limit.
	SIZE% - 2) THEN	
770	YCENTER% = (YMAX% -	
	SIZE% - 2)	
780	ELSE	
790	IF YCENTER% < (SIZE% +	Enforce the bottom side limit.
	2) THEN	
800	YCENTER% = (SIZE% + 2)	
810	END IF	
820	END IF	
830	END IF	
840	END IF	
850	LOOP	The position of the square has now been adjusted.
860	CLS	Clear the computer CRT.
870	ADDRESS& = DISPLAY&: A\$ =	Erase the user graphics display, and set the
	"AF; SP5;": GOSUB 100UTS	analyzer display's color to that of the graticule by
		using a display graphics command.
880	GOSUB DRAWSQUARE	Redraw the square in its final color.
890	FOR I% = 1 TO 9	Draw a grid with ten divisions along each axis in
		the square.
900	OFFSET% = (2 * SIZE% * I% /	Determine the distance between the I%th grid line
	10) - SIZE%	and the zero axis.

<pre> 910 A\$ = "PU; PA" +       STR\$(XCENTER% +       OFFSET%) + "," +       STR\$(YCENTER% - SIZE%)       + ";": GOSUB IDOUTS </pre>	
<pre> 920 A\$ = "PD; PA" +       STR\$(XCENTER% +       OFFSET%) + "," +       STR\$(YCENTER% + SIZE%) +       ";": GOSUB IDOUTS </pre>	<p>Draw the I%th vertical grid line.</p>
<pre> 930 A\$ = "PU; PA" +       STR\$(XCENTER% - SIZE%)       + "," + STR\$(YCENTER% +       OFFSET%) + ";": GOSUB       IDOUTS </pre>	
<pre> 940 A\$ = "PD; PA" +       STR\$(XCENTER% + SIZE%) +       "," + STR\$(YCENTER% +       OFFSET%) + ";": GOSUB       IDOUTS </pre>	<p>Draw the I%th horizontal grid line.</p>
<pre> 950 NEXT IX </pre>	
<pre> 960 ADDRESS% = DISPLAY%: A\$ =       "SP1;": GOSUB IDOUTS </pre>	<p>Set the analyzer display's color to that of channel 1 data by using a display graphics command.</p>
<pre> 970 BOTTOM% = REFB% - REFP% *       SCAL% </pre>	<p>Calculate the value of the bottom grid line.</p>
<pre> 980 FULL% = 10 * SCAL% </pre>	<p>Calculate the value of the full scale span across the grid.</p>
<pre> 990 X% = XCENTER% - SIZE% </pre>	<p>Determine the x-position of the first point to plot.</p>
<pre> 1000 Y% = ((DAT!(1, 1) -       BOTTOM%) / FULL% * 2 *       SIZE%) + YCENTER% - SIZE% </pre>	<p>Determine the y-position of the first point to plot.</p>
<pre> 1010 ADDRESS% = DISPLAY%: A\$ =       "PU; PA" + STR\$(X%) + ","       + STR\$(Y%) + ";": GOSUB       IDOUTS </pre>	<p>Position the graphics pen at the first point to plot.</p>
<pre> 1020 FOR IX = 2 TO POINTS% </pre>	<p>Draw the trace, point by point, using display graphics commands.</p>
<pre> 1030 X% = (((IX - 1) /       (POINTS% - 1)) * 2 *       SIZE%) + XCENTER% -       SIZE% </pre>	
<pre> 1040 Y% = ((DAT!(1, IX) -       BOTTOM%) / FULL%) * 2 *       SIZE%) + YCENTER% -       SIZE% </pre>	
<pre> 1050 A\$ = "PD; PA" + STR\$(X%)       + "," + STR\$(Y%) + ";":       GOSUB IDOUTS </pre>	
<pre> 1060 NEXT IX </pre>	
<pre> 1070 CALL IDLOCAL(ISC%): GOSUB       ERRORTRAP </pre>	<p>Return the network analyzer to local mode and perform error trapping.</p>
<pre> 1080 END </pre>	<p>End program execution.</p>
<pre> 1090 ERRORTRAP: </pre>	<p>Define a routine to trap errors.</p>
<pre> 1100 IF PCIB.ERR &lt;&gt; NOERR THEN       ERROR PCIB.BASERR </pre>	<p>Perform error trapping.</p>

1110 RETURN	Return from the ERRORTRAP routine.
1120 IDOUTS:	Define a routine to send a command string from the computer to the analyzer.
1130 CALL IDOUTPUTS(ADDRESS&, A\$, LEN(A\$)): GOSUB ERRORTRAP	Send the command string A\$ out to the analyzer and perform error trapping.
1140 RETURN	Return from the IDOUTS routine.
1150 DRAWSQUARE:	Define a routine to draw a square on the analyzer's display.
1160 ADDRESS& = DISPLAY&: A\$ = "AF;": GOSUB IDOUTS	Erase the old square using display graphics commands.
1170 A\$ = "PU; PA" + STR\$(XCENTER% - SIZE%) + ", " + STR\$(YCENTER% - SIZE%) + ";": GOSUB IDOUTS	Position the "pen" at the lower left corner of the square.
1180 A\$ = "PD; PA" + STR\$(XCENTER% - SIZE%) + ", " + STR\$(YCENTER% + SIZE%) + ";": GOSUB IDOUTS	Draw the left side of the square.
1190 A\$ = "PD; PA" + STR\$(XCENTER% + SIZE%) + ", " + STR\$(YCENTER% + SIZE%) + ";": GOSUB IDOUTS	Draw the top side of the square.
1200 A\$ = "PD; PA" + STR\$(XCENTER% + SIZE%) + ", " + STR\$(YCENTER% - SIZE%) + ";": GOSUB IDOUTS	Draw the right side of the square.
1210 A\$ = "PD; PA" + STR\$(XCENTER% - SIZE%) + ", " + STR\$(YCENTER% - SIZE%) + ";": GOSUB IDOUTS	Draw the bottom side of the square.
1220 RETURN	Return from the DRAWSQUARE routine.
1230 GETKEY:	Define a routine to wait for an analyzer key to be pressed and to get the key's code.
1240 STAT% = 0	Initialize STAT% for entry into the DO UNTIL loop.
1250 DO UNTIL ((STAT% MOD 64) > 31)	Wait for a key press to be indicated by the setting of bit 5 of the status byte.
1260 CALL IDSPOLL(VNA&, STAT%): GOSUB ERRORTRAP	Read in the status byte as an integer.
1270 LOOP	
1280 ADDRESS& = VNA&: A\$ = "ESR?": GOSUB IDOUTS	Now that a key press has occurred, request the Event Status Register value from the analyzer.
1290 CALL IDENTER(VNA&, ESTAT!)	Receive the Event Status Register value from the analyzer, thereby clearing the latched User Request bit so that old key presses will not trigger a measurement.
1300 ADDRESS& = VNA&: A\$ = "KOR?": GOSUB IDOUTS	Request the key code or knob count from the analyzer.

1310 CALL IDENTER(VNA&, KEYCODE!)	Receive the key code or knob count.
1320 KEYCODE% = INT(KEYCODE!)	Convert the key code or knob count to an integer.
1330 RETURN	Return from the GETKEY routine.

### Running the program

1. Set up the analyzer to make a measurement before running the program.
2. Adjust the size of the display box from the network analyzer front panel using the knob. Press [ENTRY OFF] when the size is satisfactory.
3. Adjust the position of the display box from the network analyzer front panel using the knob and the up and down keys. Press [ENTRY OFF] when the position is satisfactory.
4. The computer sends the analyzer commands that draw a grid and the trace in the box on the analyzer's display.

# Appendix A: Status Reporting

The status reporting mechanism of the network analyzer gives information about specific functions and events inside the network analyzer. The status byte is an 8-bit register, each bit of which summarizes the state of one aspect of the instrument. For example, the error queue summary bit will always be set if there are any errors in the queue. The value of the status byte can be read in two ways. The first way is to send the command `OUTPSTAT`. The second is to call the HP-IB Command Library routine `IO$POLL`:

```
CALL IO$POLL(VNA&, STAT%): GOSUB ERRORTRAP
```

The advantage of using this instead of the command `OUTPSTAT` is that this does not put the analyzer into the remote mode, and it thus gives the operator access to the network analyzer front panel functions. Reading the status byte does not affect its value.

In addition to the error queue, the status byte also summarizes the two Event Status Registers that monitor specific instrument conditions. Furthermore, the status byte has a bit that is set when the analyzer is issuing a service request over HP-IB and a bit that is set when the network analyzer is prepared to transmit data over HP-IB. For a definition of the status registers, see Figure A.1, *Status Reporting System*.

To tell if a bit of the status byte is set, it is necessary to determine the integer value corresponding to that bit (bit  $n$  is equivalent to  $2^n$ ). `MOD` can be used to remove the effect of all bits of higher value than the one of interest, and `>` can be used to see if the bit of interest is set. For example, bit 4 corresponds to an integer value of 16, and bit 5 corresponds to an integer value of 32. If `STAT%` is the integer representation of the status byte, the following `IF . . . THEN` loop will only be entered if bit 4 is set:

```
IF ((STAT% MOD 32) > 16) THEN . . .
```

## Example A1: Error queue

The following program illustrates how to monitor the analyzer's error queue from the computer. The error queue holds up to twenty instrument errors and warnings in the order that they occurred. Each time the network analyzer detects an error condition, it writes a message to its display and puts the error in the error queue. If there are any errors in the queue, bit 3 of the status byte will be set. Once the computer detects that bit 3 is set, the error can be requested from the queue with `OUTPERRO`, which commands the network analyzer to transmit the number and message of the oldest error in the queue.

Because the error queue will keep up to twenty errors until either all the errors are read out or the instrument is preset, it is important to clear out the error queue whenever errors are detected. Only errors, not prompts, are put in the error queue.

This example program is stored on the Example Programs disk as `IPGA1.BAS`.

10	REM \$INCLUDE: 'QBSETUP'	Call the QuickBASIC initialization file QBSETUP.
20	CLS	Clear the computer CRT.
30	ISC& = 7	Assign the interface select code to a variable.
40	VNA& = 716	Assign the analyzer's address to a variable.
50	CALL IOTIMEOUT(ISC&, 10!): GOSUB ERRORTRAP	Define a system time-out of ten seconds and perform error trapping.
60	CALL IOABORT(ISC&): GOSUB ERRORTRAP	Abort any HP-IB transfers and perform error trapping.
70	CALL IOCLEAR(ISC&): GOSUB ERRORTRAP	Clear the analyzer's HP-IB interface and perform error trapping.
80	CALL IOEOI(ISC&, 0): GOSUB ERRORTRAP	Disable the End-Or-Identify mode for transferring data and perform error trapping.
90	LENGTH% = 50	Set a maximum length for the string to hold the error data.
100	ERRDATA\$ = SPACE\$(LENGTH%)	Prepare a string to hold the error data.

110 STATUSPOLL: STAT% = 0	Initialize the status byte for entry into the DO UNTIL loop.
120 DO UNTIL ((STAT% MOD 16) > 7)	Loop until bit three of the status byte, the error queue summary, is set.
130 CALL IOSPOLL(VNA%, STAT%): GOSUB ERRORTRAP	Read the status byte into the variable STAT% using a serial poll. The serial poll is an HP-IB function dedicated specifically to getting the status byte of an instrument quickly without causing the instrument to go into remote mode.
140 LOOP	
150 A\$ = "OUTPERRO;": GOSUB IOOOTS	Now that the error queue has something in it, instruct the analyzer to output the error data, which consists of an error number and an error message string. This communication with the network analyzer puts it in remote mode.
160 ACTUAL% = 0	Initialize the actual number of bytes read in. This variable is set during IOENTERS.
170 CALL IOENTERS(VNA%, ERRDATA\$, LENGTH%, ACTUAL%): GOSUB ERRORTRAP	Read the error data into one string. This will then consist of the error number (as a string) and the error message string.
180 ERRNUM% = VAL(LEFT\$(ERRDATA\$, 5))	Extract the error number from the string read in.
190 I% = 9	Initialize the string counter to begin after the error number.
200 ERRID\$ = ""	Initialize the error message string.
210 DO UNTIL MID\$(ERRDATA\$, I%, 1) = CHR\$(34)	Repeat until the end of the string has been reached.
220 ERRID\$ = ERRID\$ + MID\$(ERRDATA\$, I%, 1)	Extract the error message from the error data string one character at a time.
230 I% = I% + 1	Increment the counter at the next character.
240 LOOP	
250 PRINT ERRNUM%; " : "; ERRID\$	Display the error number and error message string on the computer CRT.
260 CALL IOLOCAL(ISC%): GOSUB ERRORTRAP	Return the network analyzer to local mode so that the front panel is available to the operator. Perform error trapping.
270 SOUND 550, 2	Indicate audibly that an error occurred.
280 GOTO STATUSPOLL	Continue polling for errors.
290 END	End program execution.
300 ERRORTRAP:	Define a routine to trap errors.
310 IF PCIB.ERR <> NOERR THEN ERROR PCIB.BASERR	Perform error trapping.
320 RETURN	Return from the ERRORTRAP routine.
330 IOOOTS:	Define a routine to send a command string from the computer to the analyzer.
340 CALL IOOUTPUTS(VNA%, A\$, LEN(A\$)): GOSUB ERRORTRAP	Send the command string A\$ out to the analyzer and perform error trapping.
350 RETURN	Return from the IOOOTS routine.

## Running the program

1. Preset the network analyzer and run the program.
2. Nothing happens until an error occurs, so generate one. Three possible ways to do this on the network analyzer are the following:
  - a. Press a blank softkey.
  - b. Loosen the R connection.
  - c. Press **[CAL] [CALIBRATE MENU] [RESPONSE] [DONE: RESPONSE]**.
3. Once an error occurs, the computer will continue to beep and to display the error number and message until the error queue is empty (until the error number 0 and the error message **NO ERRORS** are received).
4. The computer will continue to monitor the network analyzer's error queue until the operator ends the program by pressing **<CTRL-Break>** on the computer keyboard.

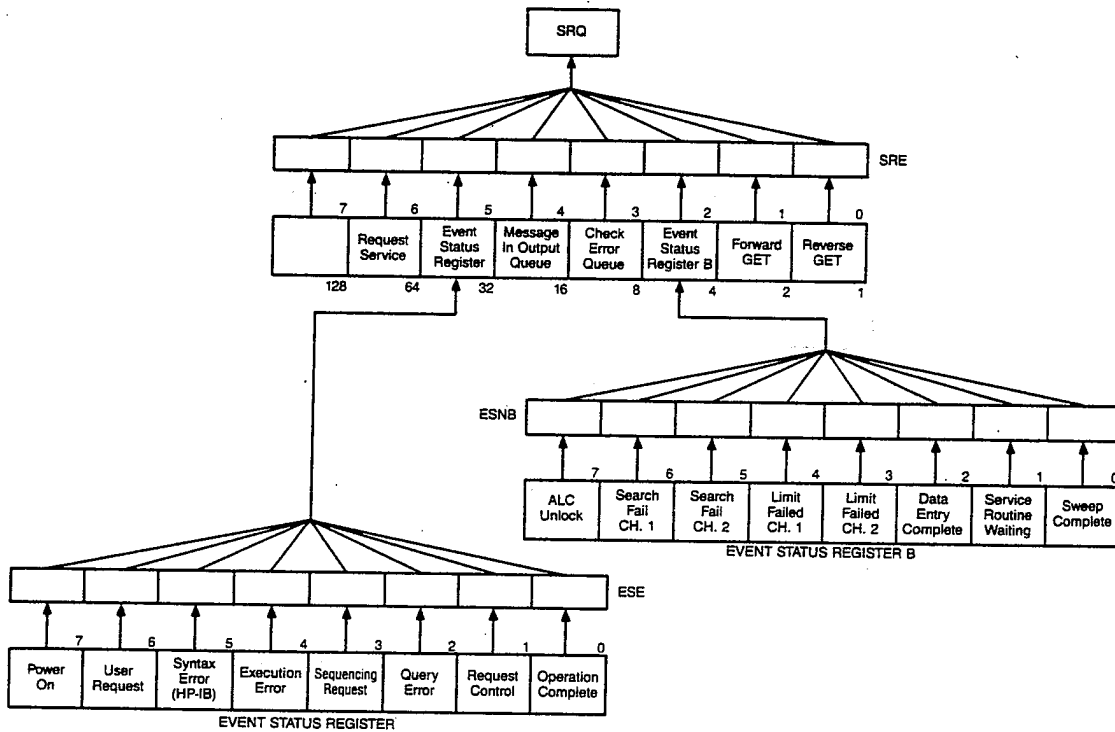

Figure A.1. Status reporting system

## Example A2: Status registers

The following program illustrates how to monitor the analyzer's Event Status Register from the computer. The Event Status Registers are 8-bit registers which consist of latched event bits. A latched bit is set at the onset of the monitored condition. It is cleared when the register is read or when the command CLES (clear status) is sent.

Each time the network analyzer detects a key press or knob turn, it sets bit 6 of the Event Status Register. Once the computer detects that bit 6 is set, the key code or knob count can be requested from the analyzer with KOR?. Note that since the network analyzer is in remote mode, the normal function of the key pressed is not executed. In effect, the front panel has been taken over, and the keys could now be redefined.

This example program is stored on the Example Programs disk as **IPGA2.BAS**.

10	REM \$INCLUDE: 'QBSETUP'	Call the QuickBASIC initialization file QBSETUP.
20	CLS	Clear the computer CRT.
30	ISC& = 7	Assign the interface select code to a variable.
40	VNA& = 716	Assign the analyzer's address to a variable.
50	CALL IOTIMEOUT(ISC&, 10!): GOSUB ERRORTRAP	Define a system time-out of ten seconds and perform error trapping.
60	CALL IOABORT(ISC&): GOSUB ERRORTRAP	Abort any HP-IB transfers and perform error trapping.
70	CALL IOCLEAR(ISC&): GOSUB ERRORTRAP	Clear the analyzer's HP-IB interface and perform error trapping.
80	CALL IOEDI(ISC&, 0): GOSUB ERRORTRAP	Disable the End-Or-Identify mode for transferring data and perform error trapping.
90	GETKEY: ESTAT! = 0	Initialize ESTAT! for entry into the DO UNTIL loop.
100	DO UNTIL ((ESTAT! MOD 128) >63)	Wait for a key press to be indicated by the setting of bit 6, User Request, of the Event Status Register. MOD 128 removes the effect of all higher value bits (bit 7 is equivalent to 128 in decimal), and >63 ensures that bit 6, which is equivalent to 64 in decimal, is set.
110	A\$ = "ESR?;": GOSUB IOOUTS	Request the Event Status Register value from the analyzer.
120	CALL IOENTER(VNA&, ESTAT!): GOSUB ERRORTRAP	Receive the Event Status Register value from the analyzer, thereby clearing the latched User Request bit so that old key presses will not trigger a measurement.
130	LOOP	
140	A\$ = "KOR?;": GOSUB IOOUTS	Since the User Request bit has been set, request the key code or knob count from the analyzer.
150	CALL IOENTER(VNA&, KEYCODE!): GOSUB ERRORTRAP	Receive the key code or knob count from the analyzer.
160	IF KEYCODE! > = 0 THEN	If the code is positive, it was a key press rather than a knob turn.
170	PRINT "KEY CODE = ";	
180	ELSE	The code is negative, so it was a knob turn.
190	PRINT "KNOB TURN = ";	
200	IF KEYCODE! < -400 THEN	If the turn was a counter-clockwise rotation, the code needs to be recovered.
210	KEYCODE! = KEYCODE! + 32768	



220	END IF	
230	END IF	
240	PRINT KEYCODE!	Display the code or knob count on the computer CRT.
250	GOTO GETKEY	Wait for the next key press or knob turn.
260	CALL IOLOCAL(ISC&): GOSUB ERRORTRAP	Return the network analyzer to local mode and perform error trapping.
270	END	End program execution.
280	ERRORTRAP:	Define a routine to trap errors.
290	IF PCIB.ERR <> NOERR THEN ERROR PCIB.BASERR	Perform error trapping.
300	RETURN	Return from the ERRORTRAP routine.
310	IOOOTS:	Define a routine to send a command string from the computer to the analyzer.
320	CALL IOOUTPUTS(VNA&, A\$, LEN(A\$)): GOSUB ERRORTRAP	Send the command string A\$ out to the analyzer and perform error trapping.
330	RETURN	Return from the IOOOTS routine.

### Running the program

1. Preset the network analyzer and run the program.
2. Nothing happens until a key is pressed, so press one.
3. The computer will detect the key press or knob turn and display its code.
4. The computer will continue to monitor the network analyzer's key presses and knob turns until the operator ends the program by pressing <CTRL-Break> on the computer keyboard.

**For more information, call your local HP sales office listed in your telephone directory or an HP regional office listed below for the location of your nearest sales office.**

**United States:**

Hewlett-Packard Company  
4 Choke Cherry Road  
Rockville, MD 20850  
(301) 670-4300

Hewlett-Packard Company  
5201 Tollview Drive  
Rolling Meadows, IL 60008  
(312) 255-9800

Hewlett-Packard Company  
5161 Lankershim Blvd.  
No. Hollywood, CA 91601  
(818) 505-5600

Hewlett-Packard Company  
2015 South Park Place  
Atlanta, GA 30339  
(404) 955-1500

**Canada:**

Hewlett-Packard Ltd.  
6877 Goreway Drive  
Mississauga, Ontario L4V1M8  
(416) 678-9430

**Australia/New Zealand:**

Hewlett-Packard Australia Ltd.  
31-41 Joseph Street,  
Blackburn, Victoria 3130  
Melbourne, Australia  
(03) 895-2895

**Europe/Africa/Middle East:**

Hewlett-Packard S.A.  
Central Mailing Department,  
P.O. Box 529  
1180 AM Amstelveen,  
The Netherlands  
(31) 20/547 9999

**Far East:**

Hewlett-Packard Asia Ltd.  
22/F Bond Centre  
West Tower  
89 Queensway  
Central, Hong Kong  
(5) 8487777

**Japan:**

Yokogawa-Hewlett-Packard Ltd.  
29-21, Takaido-Higashi 3-chome  
Suginami-ku, Tokyo 168  
(03) 331-6111

**Latin America:**

Latin American Region Headquarters  
Monte Pelvoux Nbr. 111  
Lomas de Chapultepec  
11000 Mexico, D.F. Mexico  
(905) 596-79-33



**HEWLETT  
PACKARD**

**November 1, 1989**

Copyright ©1989  
Hewlett-Packard  
Company  
Printed in U.S.A.  
08753-90168

## For the HP 8700-series analyzers

This document provides a quick reference for the HP-IB operation of the HP 8700-series analyzers, including the HP 8702, 8703, 8719, 8720, 8752, and 8753. Use this information as a reference to the syntax requirements and general function of the individual commands. You should already be familiar with making measurements with the analyzer using the front panel keys and with general programming of the instrument using the HP-IB.

Not all commands listed apply to all instruments. The general response of an instrument that does not support a specific operation is to report a syntax error when the command is input. Refer to the tutorial and reference information in other portions of the Operating and Programming manual, particularly the menu structures, for the specific instrument you are working with to determine its capabilities.

### Contents

Notation .....	1	Status Bit Definitions .....	8
Display Graphics Codes .....	2	Calibration Types and Standard Classes .....	9
User Graphics Units .....	3	Calibration Arrays .....	9
Processing Chain .....	3	Alphabetical List of Codes .....	10
Marker and Data Array Units .....	4	List of OPC'able Codes .....	21
Disk File Names .....	5	Interrogate Instrument State	
Key Codes .....	6	(Query) Commands .....	21
Status Reporting Structure .....	7		

### Notation

Symbols used in this document are:

- BOLD** Upper case bold characters represent the program keywords which must appear exactly as shown with no embedded spaces.
- [ ] Square brackets indicate that the enclosed information is optional.
- [suffix] Optional programmer entry Units Terminator for stimulus values:

Frequency Suffix	Time Suffix	Voltage Suffix	Power Suffix
	fs		
	ps		
GHz	ns		
MHz	us (micro)		
kHz	ms	mV	
Hz	s	V	dB

If no suffix is used, the instrument assumes the basic units (Hz or seconds) for the instruction. Upper and lower case characters are equivalent.

- <appendage> Characters enclosed in the <> brackets are qualifiers attached to the root mnemonic. An example is <ON|OFF> which shows that either **ON** or **OFF** can be attached to the code. Another is <1-6> which shows that the numeral 1, 2, 3, 4, 5, or 6 can be attached to the code. There can be no spaces or symbols between the code and the appendage.
- ;
- ,
- (range of values) Lower case characters enclosed in parentheses describe the range of values which may be input for the selected function.
- value A constant or a pre-assigned simple or complex numeric or string variable transferred to the instrument.

# Display Graphics

## HP-GL subset

**AF;** Erases the user graphics display.

**CS;** Turns off the measurement display.

**DF;** Sets the default values.

**DIX,Y;** Sets absolute character direction.

<u>x</u>	<u>y</u>	<u>Character direction</u>
1	0	0°
0	0	90°
-1	0	180°
0	-1	270°

**LB[text][etx];** Labels the display, placing the symbols starting at the current pen position. All incoming characters are printed until the etx symbol is received. The default etx symbol is the ASCII value 3 (not the character 3).

**LTa;** Specifies line type: 

<u>a</u>	<u>line</u>
0	solid
1	solid
2	short dashes
3	long dashes

**OP;** Outputs P1 and P2, the scaling limits: 0,0,5850,4095.

**PAX,y;** Draws from the current pen position to x,y. There can be several pairs of x,y coordinates within one command. They are separated by commas, and the entire sequence is terminated with a semicolon.

**PD;** Pen down. A line is drawn only if the pen is down.

**PG;** Erases the user graphics display.

**PRx,y;** Plot relative: draws a line from the current pen position to a position y up and x over.

**PU;** Pen up. Stops anything from being drawn.

**RS;** Turns on the measurement display.

**Slh,w;** Sets the character size, for height h and width w in centimeters:

<u>h</u>	<u>w</u>	<u>size</u>
.16	.20	smallest
.25	.30	
.33	.39	
.41	.49	largest

**SPn;** Selects color: n = 1-7

**COLORm;** m = 1-7

## Accepted but ignored HP-GL commands

**IM** Input service request mask  
**IP** Input P1, P2 scaling points  
**IW** Input window  
**OC** Output current pen position  
**OE** Output error  
**OI** Output identity  
**OS** Output status  
**SL** Character slant  
**SR** Relative character size

# User Graphics Units

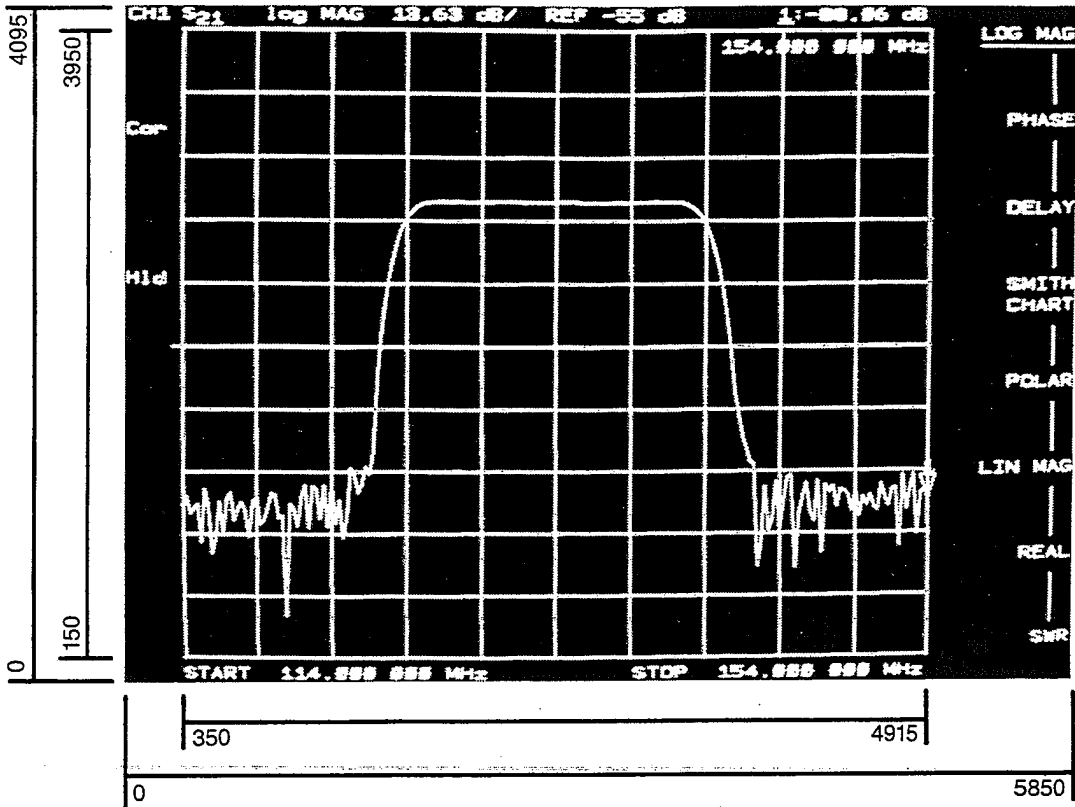

## Processing Chain

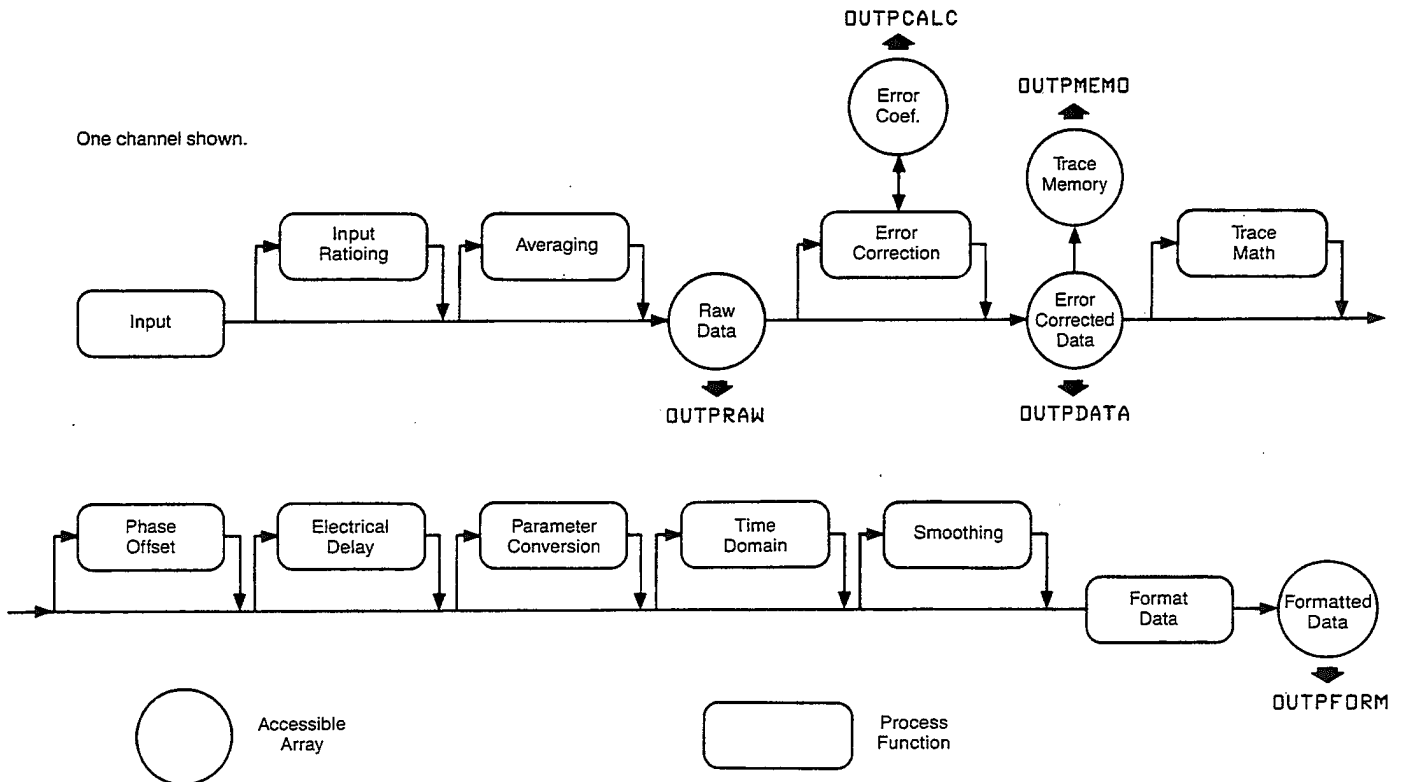

## Marker and Data Array Units

DISPLAY FORMAT	MARKER MODE	OUTPMARK value 1, value 2	OUTPFORM value 1, value 2	MARKET READOUT** value, aux value
LOG MAG		dB,*	dB,*	dB,*
PHASE		degrees,*	degrees,	degrees,*
DELAY		seconds,*	seconds,*	seconds,*
SMITH CHART	LIN MKR	lin mag, degrees	real, imag	lin mag, degrees
	LOG MKR	dB, degrees	"	dB, degrees
	Re/Im	real, imag	"	real, imag
	R + jX	real, imag ohms	"	real, imag ohms
	G + jB	real, imag Siemens	"	real, imag Siemens
POLAR	LIN MKR	lin mag, degrees	real, imag	lin mag, degrees
	LOG MKR	dB, degrees	"	dB, degrees
	Re/Im	real, imag	"	real, imag
LIN MAG		lin mag,*	lin mag,*	lin mag,*
REAL		real,*	real,*	real,*
SWR		SWR,*	SWR,*	SWR,*

\* Value not significant in this format, but is included in data transfers.

\*\* The marker readout values are the marker values displayed in the upper left hand corner of the display. They also correspond to the value and aux value associated with the fixed marker.

## Disk file names

Disk file names consist of a user-defined state name of up to 8 characters, such as FILTER, appended with up to two characters, defined by the instrument, which indicate what is in the file. ASCII files use the CITIFile format. Binary files are not meant to be decoded.

### FILTERXX

The first character is the file type, telling the kind of information in that file. The second character is a data index, used to distinguish files of the same type.

Char 1	Meaning	Char 2	Meaning
I	Instrument state	(blank)	
G	Graphics	1	Display graphics
		0	Graphics index
D	Error corrected data	1	Channel 1
		2	Channel 2
R	Raw data	<b>Binary</b>	
		1 to 4	Channel 1, raw arrays 1 to 4
		5 to 8	Channel 2, raw arrays 1 to 4
<b>CITIFILE: single file</b>			
			Last digit 1 (ch 1) or 5 (ch 2)
F	Formatted data	1	Channel 1
		2	Channel 2
M	Memory trace	1	Channel 1
		2	Channe 2
1	Cal data, channel 1	<b>Binary:</b>	
		K	Cal kit
		0	Stimulus state
		1 to 9	Coefficients 1 to 9
		A	Coefficient 10
		B	Coefficient 11
		C	Coefficient 12
			} Multiple files
<b>CITIFILE: single file</b>			
			last digit shows number of coefficients
2	Cal data, channel 2	0 to C,K	Same as channel 1

# Key Codes

## Notes:

1. Key code 63 is invalid key.
2. **OUTPKKEY**; reports a knob turn as a  $-1$ .
3. If the two byte integer sent back from **KOR?** is negative, it is a knob count. If the knob count was negative, no modification is needed. If the knob count was positive, however, bit 14 will not be set. In this case, the number must be decoded by clearing the most significant byte, as by AND'ing the integer with 255.

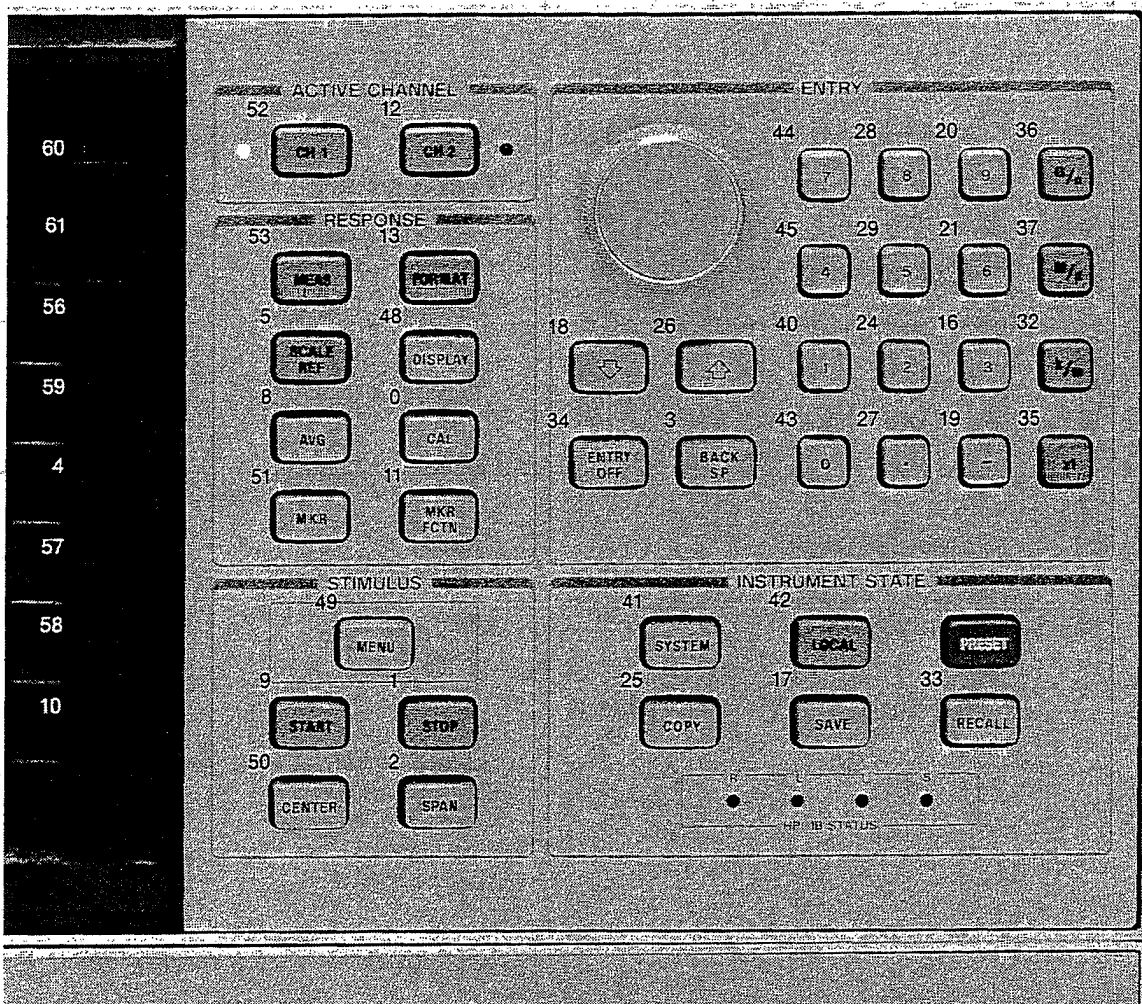



# Status Reporting Structure

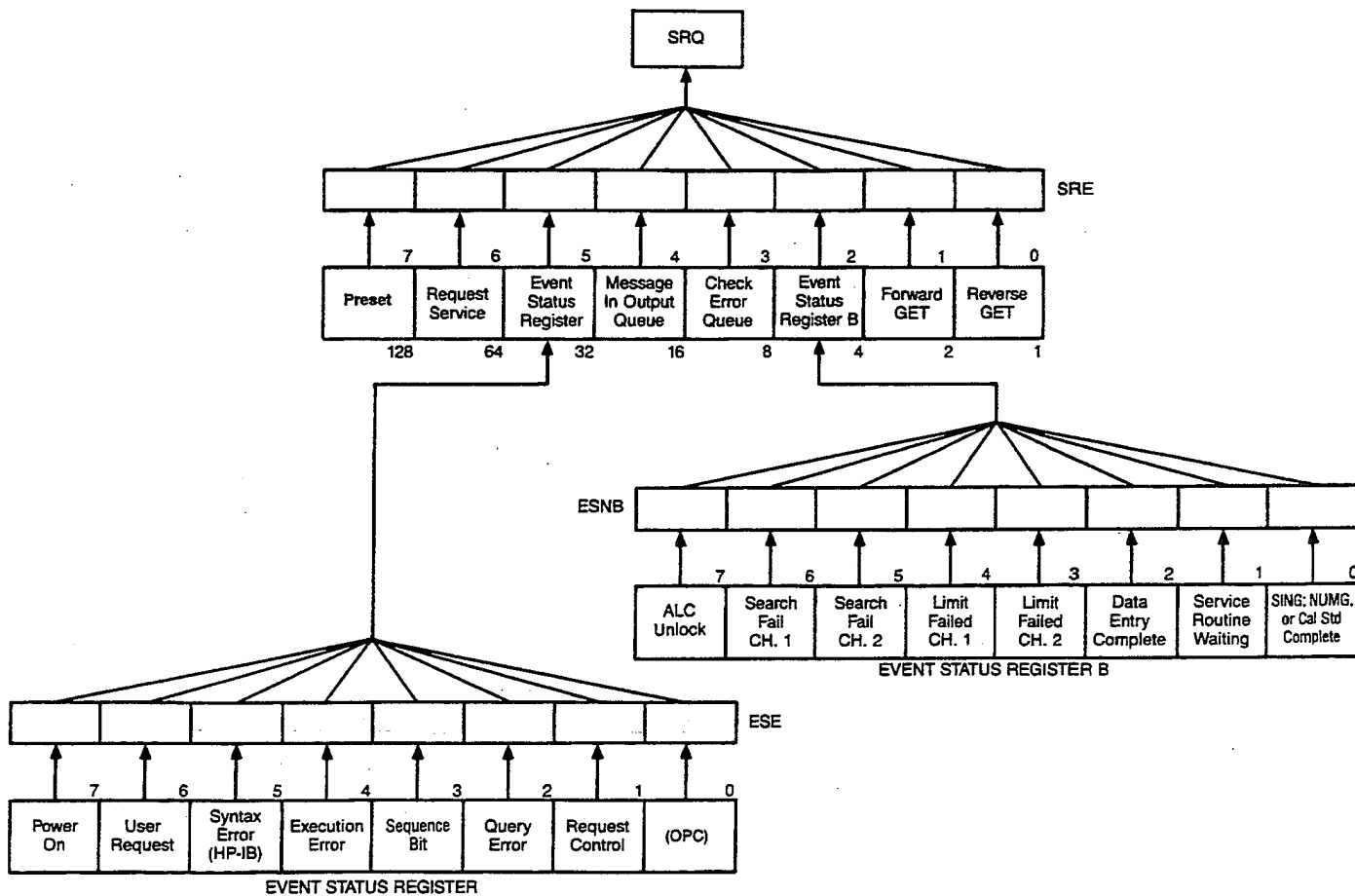

# Status Bit Definitions

## Status Byte

Bit	Name	Description
0	Waiting for reverse GET	A one path, 2-port calibration is active, and the instrument has stopped, waiting for the operator to connect the device for reverse measurement.
1	Waiting for forward GET	A one path, 2-port calibration is active, and the instrument has stopped, waiting for the operator to connect the device for forward measurement.
2	Check event status register B	One of the enabled bits in event status register B has been set.
3	Check error queue	An error has occurred and the message has been placed in the error queue, but has not been read yet.
4	Message in output queue	A command has prepared information to be output, but it has not been read yet.
5	Check event status register	One of the enabled bits in the event status register has been set.
6	Request service,	One of the enabled status byte bits is causing an SRQ.
7	Request service on Preset	The front panel preset key has been pressed.

## Event Status Register

Bit	Name	Description
0	Operation complete	A command for which OPC has been enabled completed operation.
1	Request control	The analyzer has been commanded to perform an operation that requires control of a peripheral, and needs control of HP-IB. Requires pass control mode.
2	Query error	The analyzer has been addressed to talk, but there is nothing in the output queue to transmit.
4	Execution error	A command was received that could not be executed. Commonly due to invalid operands.
5	Syntax error	The incoming HP-IB commands contained a syntax error. The syntax error is cleared only by a device clear or an instrument preset.
6	User request	The operator has pressed a front panel key or turned the knob.
7	Power on	A power on sequence has occurred since the last read of the register.

## Event Status Register

Bit	Name	Description
0	Sweep or group complete	A single sweep or group has been completed since the last read of the register. Operates in conjunction with SING or NUMG.
1	Service routine waiting or done	An internal service routine has completed operation, or is waiting for an operator response.
2	Data entry complete	A terminator key has been pressed, or a value entered over HP-IB since last read of the register.
3	Limit failed, Ch 2	Limit test failed on channel 2.
4	Limit failed, Ch 1	Limit test failed on channel 1.
5	Search failed, Ch 2	A marker search was executed, but the target value was not found.
6	Search failed, Ch 1	Same as on channel 2.
7	ALC unlock	Unleveled output power at the beginning or end of a sweep. Data may be invalid.

# Calibration Types and Standard Classes

Class	Response	Response and Isolation	S11 1-port	S22 1-port	One path 2-port	Full 2-port	E/O Response and Match	O/E Response and Match
Reflection: <sup>1</sup>					•	•	•	•
S11A (opens)			•		•	•	•	•
S11B (shorts)			•		•	•	•	•
S11C (loads)			•		•	•		
S22A (opens)				•		•		
S22B (shorts)				•		•		
S22C (loads)				•		•		
Transmission: <sup>1</sup>					•	•		
Forward match					•	•		•
Forward thru					•	•	•	•
Reverse match						•		
Reverse thru						•		
Isolation: <sup>1</sup>					•	•		
Forward					•	•	•	•
Reverse						•		
Response	•							
Response and isolation:								
Response		•						
Isolation		•						

1. These subheadings must be called when doing 2-port calibrations.

## Calibration Arrays

Array	Response	Response and Isolation	1-port	2-port <sup>1</sup>	E/O Response and Match	O/E Response and Match
1	$E_R$ or $E_T$	$E_X (E_D)^2$ $E_T (E_R)$	$E_D$ $E_S$ $E_R$	$E_{DF}$ $E_{SF}$ $E_{RF}$ $E_{XF}$ $E_{LF}$ $E_{TF}$ $E_{DR}$ $E_{SR}$ $E_{RR}$ $E_{XR}$ $E_{LR}$ $E_{TR}$	$E_{DF}$ $E_{SF}$ $E_{RF}$ $E_{XF}$ $E_{TF}$	$E_{DF}$ $E_{SF}$ $E_{RF}$ $E_{XF}$ $E_{LF}$ $E_{TF}$
2						
3						
4						
5						
6						
7						
8						
9						
10						
11						
12						

Meaning of first subscript: D=directivity; S=source match; R=reflection tracking; X=crosstalk; L=load match, T=transmission tracking.

Meaning of second subscript: F=forward; R=reverse.

1. One path, 2-port cal duplicates arrays 1 to 6 in arrays 7 to 12.

2. Response and isolation corrects for crosstalk and transmission tracking in transmission measurements, and for directivity and reflection tracking in reflection measurements.

## Alphabetical List of Codes

- AB;**  
Measure and display A/B on the active channel.
- ADDRCONT [value];**  
Controller HP-IB address.  
Control is returned to this address after a pass control.
- ADDRDISC [value];**  
Disk HP-IB address. (0-30)
- ADDRLSCR [value];**  
External source address.
- ADDRPLOT [value];**  
Plotter HP-IB address.
- ADDRPOWM [value];**  
Power Meter HP-IB address. (0-30)
- ADDRPRIN [value];**  
Printer HP-IB address. (0-30)
- ADJB;**  
Executes autobiasing of optical modulator.
- ALC;**  
ALC control.
- ALIS <ON | OFF>;**  
Select time domain span limit.  
On to display past time domain alias-free range.  
Preset selects ALISOFF;
- ALTAB;**  
Select alternate sweeps for Channel 1 and Channel 2.
- ANAB;**  
Analog bus Enable.
- ANAI;**  
Measure and display data at the Analog Input (ANALOG IN).
- ANNO <ON | OFF>;**  
Select measurement annotation.  
S-parameter test set = On;  
Reflection/transmission test set = Off.
- AR;**  
Measure and display A/R on the active channel.
- ASAMP <ON | OFF>;**  
Switch A, sampler to: ON = LW, OFF = RF.
- ASEG;**  
Measure all frequency list segments.
- ASSS;**  
Assert the sequence status bit.
- ATTP <1 | 2> [value];**  
Set port 1 or port 2 attenuator (0-90 dB, 10 dB steps).
- AUTO;**  
Automatic selection of REF VALUE and SCALE for the active channel.
- AUTB <ON | OFF>;**  
Enable or disable autobiasing of optical modulator.
- AVERFACT [value];**  
Set averaging factor for active channel.
- AVER <ON | OFF>;**  
Select averaging for active channel.
- AVERON [value];** can also be used.
- AVERREST;**  
Restart averaging on the active channel.
- BACI [0-100];**  
Background intensity percent.
- BANDPASS;**  
Select time domain bandpass mode.
- BEEPDONE <ON | OFF>;**  
Beep when done:  
Save instrument state, Calibration standard, Data trace saved.
- BEEPFAIL <ON | OFF>;**  
Beep when limit test failure.
- BEEPWARN <ON | OFF>;**  
Beep when warning message displayed.
- BR;**  
Measure and display B/R on the active channel.
- BSAMP <ON | OFF>;**  
Switch B, sampler to: ON = LW, OFF = RF.

**C0** [value];  $\times 10^{-15}F$

**C1** [value];  $\times 10^{-27}F$

**C2** [value];  $\times 10^{-36}F$

**C3** [value];  $\times 10^{-45}F$

Open circuit capacitance model values:

$$C = C0 + (C1 * F) + (C2 * F^2) + (C3 * F^3)$$

**CAL1**;

Begin measurement calibration.

**CALFCALC** [value];

Set current frequency power meter calibration factor.

**CALFFREQ** [value[freq suffix]];

Select power meter calibration factor frequency.

**CALFSEN** < A | B >;

Edit the sensor A or B calibration factor table.

**CALIAPOW**; A input.

**CALIARPO**; A/B ratio

**CALIBPOW**; B input.

**CALIBRPO**; B/R ratio.

Begin power calibration sequence for selected measurement.

**CALIEORM**;

Select E/O response and match calibration.

**CALIFUL2**;

Select Full 2-Port measurement calibration.

**CALIOERM**; **CALIOERM**;

Select O/E response and match calibration.

**CALIONE2**;

Select One-Path 2-Port measurement calibration.

**CALIRAI**;

Select Response and Isolation measurement calibration for current parameter.

**CALIRESP**;

Select Response measurement calibration for current parameter.

**CALIS111**;

Select 1-Port measurement calibration for current parameter at port 1.

**CALIS221**;

Select 1-Port measurement calibration for current parameter at port 2.

**CALK35MM**; 3.5 mm

**CALK7MM**; 7 mm

**CALKN50**; type-N, 50 $\Omega$

**CALKN75**; type-N, 75 $\Omega$

**CALKOPTS**; Standard optical

**CALKOPTU**; User-defined optical

**CALKUSED**; Use-defined electrical

Begin measurement calibration using selected cal kit.

**CALN**;

Select Cal none.

**CALPRECE**; O/E DUT

**CALPRESP**; Response cable

**CALPRFSC**; Source RF cable

**CALPRFTC**; Total RF cable

Select calibration standard class. Measure if single standard in class, or, if multiple standards in class, use

**STAN** < char >; and **DONE**; to measure standards in

class.

**CALSRECC**; Receiver coefficients

**CALSRECD**; Receiver from disc

**CALSSOUC**; Source coefficients

**CALSSOUD**; Source from disc

Select standard location for source/receiver model.

**CBRI** [0-100];

Color brightness percent.

**CENT** [value[suffix]];

Set CENTER stimulus value.

**CHAN1**; Channel 1

**CHAN2**; Channel 2

Select Active measurement Channel.

**CHOPAB**;

Alternate measurements between Channel 1 and Channel 2 at each frequency point.

## CLAD to COUS <ON | OFF>

### CLAD;

Class done, modify cal kit, specify class.  
Current standard class is complete.

**CLASS11A;** S11A; S11 1-port

**CLASS11B;** S11B; S11 1-port

**CLASS11C;** S11C; S11 1-port

**CLASS22A;** S22A; S22 1-port

**CLASS22B;** S22B; S22 1-port

**CLASS22C;** S22B; S22 1-port

Select port 1 (S11) and port 2 (S22) calibration standard class. Measure if single standard in class, or, if multiple standards in class, use **STAN**< char >; and **DONE**; to measure standards in class.

**CLEA <1-5>;**

### CLEARALL;

Clear specified Save/Recall register or all.

### CLEAL;

### CLEL;

Clear current list:

Frequency list, Power Loss list, or Limit Test list.

**CLEASE <1-6>;**

Clear specified test sequence.

### CLES;

### CLS;

Clear Status. Clears (0) status byte, event status registers, and event status enable registers.

### COAX;

Define current cal standard as Coaxial (linear phase).

**COEF <A-I>;**

Set optical cal **STDTSOUR**; and **STDTRECE**; coefficients.

**COEFA <1-4> [value];**

Set numerator coefficients of response model.

**COEFB <1-4> [value];**

Set denominator coefficients of response model.

**COEFDELA [value];**

Set delay coefficient of response model.

### COEFK;

Set scaling coefficient of the response model.

**COLOCH1D;** Ch 1 data, limit line

**COLOCH1M;** Ch 1 memory

**COLOCH2D;** Ch 2 data, limit line

**COLOCH2M;** Ch 2 memory

**COLOGRAT;** Graticule

**COLOMEM1;** Memory 1

**COLOMEM2;** Memory 2 and Ref. line

**COLOTEXT;** Text

**COLOWARN;** Warning message

Specify display element to change color.

**COLOR [0-100];**

Specify saturation percent.

### CONS;

Continue test sequence.

### CONT;

Continuous sweep trigger mode.

**CONV1DS;** Reciprocal (1/S)

**CONVOFF;** Conversion Off

**CONVYREF;** Y: reflection

**CONVYTRA;** Y: transmission

**CONVZREF;** Z: reflection

**CONVZTRA;** Z: transmission

Convert current measurement.

### COPYFRFT;

Copy file titles to register titles.

### COPYFRRT;

Copy save/recall register titles to disc.

**CORI <ON | OFF>;**

Select Interpolative error correction for active channel.

**CORR <ON | OFF>;**

Select error correction for active channel current parameter set.

**COUC <ON | OFF>;**

Couple/Uncouple channel stimulus values.

**COUP <ON | OFF>;**

Couple power when uncoupled channels.

**COUS <ON | OFF>;**

Switch coupling to measurement parameter on or off.

**CWEXT;**  
CW mode using external input.

**CWFREQ** [value[freq suffix]];  
Select CW frequency in single frequency measurement modes. During frequency list edit, set center frequency of current segment.

**CWTIME;**  
Select CW time sweep type.

**D1DIVID2 < ON | OFF >;**  
Perform complex divide of current Channel 1 data by current Channel 2 data and display in Channel 2. Dual channel only.

**DATI;**  
Active channel data stored to trace memory.

**DEBU < ON | OFF >;**  
Select HP-IB program debug mode to display instrument commands.

**DECONV;**  
Select down conversion.

**DECRLOOC;**  
Decrement test sequence loop counter by one.

**DEFC;** Set default colors.

**DEFOKIT;**  
Default optical kit.

**DEFS** [std no.];  
Define number of cal standard to be modified.

**DELA;**  
Select DELAY format for current measurement.

**DELO;**  
Delta Marker mode Off.

**DEL R < 1-4 >;**  
Select delta reference marker.

**DELRFIXM;**  
Select fixed marker as delta reference marker.

**DEMOAMPL;** Amplitude Demodulation  
**DEMOOFF;** Demodulation Off  
**DEMOPHAS;** Phase Demodulation  
Select CW Time transform demodulation.

**DEVT1PE;** 1-port electrical  
**DEVT1PO;** 1-port optical  
**DEVTEE;** E/E  
**DEVTEO;** E/O  
**DEVTOE;** O/E  
**DEVTOO;** O/O  
Specify current device type.

**DFLT;**  
Select default plotter setup.

**DIRS** [value];  
Set the number of files in directory at disc initialization.

**DISCUNIT** [value];  
Specify disc unit number.  
Usually 0 (left drive); 1 (right drive).

**DISCVOLU** [value];  
Specify disc volume number.

**DISM < ON | OFF >;**  
Select display of all four marker values.

**DISPDATA;** Display data  
**DISPDATM;** Display both data and memory  
**DISPDDM;** Display data divided by memory  
**DISPDMM;** Display data minus memory  
**DISPMATH;** Display current math function  
**DISPDPM;** Display data plus memory  
**DISPDTM;** Display data times memory  
**DISPM1DM;** Display memory 1 divided by memory 2  
**DISPM1MM;** Display memory 1 minus memory 2  
**DISPM1PM;** Display memory 1 plus memory 2  
**DISPM1TM;** Display memory 1 times memory 2  
**DISPM2DM;** Display memory 2 divided by memory 1  
**DISPM2MM;** Display memory 2 minus memory 1  
**DISPM2PM;** Display memory 2 plus memory 1  
**DISPMEMO;** Display memory only  
Select display for active channel.

**DIVI;**  
Select complex divide default trace math.

## DONACAL to FIXE

**DONACAL;**

**DONARCAL;**

**DONBCAL;**

**DONBRCAL;**

Done with power meter calibration sequence.

**DONE;**

Done with standard class during cal.

**DONM;**

Done with modify test sequence.

**DOSE < 1-6 >;**

Do specified test sequence.

**DOWN;**

Decrement current active function value.

**DRIVPORT < ON | OFF >;**

Drive port; ON=LW, OFF=RF.

**DUAC < ON | OFF >;**

Select dual (On) or single channel (Off) display.

**DUPLSE < 1-6 > SEQ < 1-6 >;**

Duplicate test sequence (from-to).

**EOCAL;**

Internal E/O service calibration parameter.

**EDITDONE;**

Done with edit frequency list or edit limit line table.

**EDITLIML;**

Begin edit limit line table.

**EDITLIST;**

Begin edit frequency list.

**ELEA [value];**

Electrical attenuation for power cal.

**ELED [value[time suffix]];** Set electrical delay for active channel.

**EMIB;**

Beep during test sequence.

**ENTO;**

Entry Off.

Turn off active function and clear entry area.

**ESB?;**

Output event status register B value.

**ESE [value];**

Specify bits of event status register to be summarized by bit 5 of the status byte.

**ESNB [value];**

Specify bits of event status register B to be summarized by bit 2 of the status byte.

**ESR?;**

Output event status register value.

**EXET;**

Execute a service test.

**EXTAOPTI;**

Extension auxiliary optical port.

**EXTMDATA < ON | OFF >;** Error-corrected data.

**EXTMFORM < ON | OFF >;** Formatted data

**EXTMGRAP < ON | OFF >;** User graphics

**EXTMRAW < ON | OFF >;** Raw data arrays

Specify data types included in register storage to disc.

**EXTOINPU;**

Extension optical input.

**EXTOSOUR;**

Extension optical source.

**EXTT < ON | OFF >;**

External/Internal trigger

**EXTTHIGH;**

(HP-IB only) Selects external trigger on low to high signal transition.

**EXTTLOW;**

(HP-IB only) Selects external trigger on high to low signal transition.

**EXTTPOIN;** External trigger

Select internal or external measurement trigger mode.

**EXTTOFF;**

Selects external trigger off.

**EXTTON;**

Selects external trigger on.

**FAST;**

Select fast plot speed.

**FIXE;**

Define load standard type as fixed.



**FOCU [0-100];**  
Set CRT focus value percent.

**FORM1;** Instrument internal binary  
**FORM2;** IEEE 32-bit fp (8 bytes/point)  
**FORM3;** IEEE 64-bit fp (16 bytes/point)  
**FORM4;** ASCII  
**FORM5;** PC-DOS 32-bit fp (8 bytes/point)  
 Select HP-IB trace data input/output formats.

**FREQ;**  
Select frequency annotation Off.  
(Preset to turn On).

**FREQOFFS < ON | OFF >;**  
Select frequency offset mode.

**FREQRANG < 3GHZ | 6GHZ >;**  
Select frequency doubler in HP 85047 test set.

**FRER;**  
Select internal trigger free-run sweep (same as CONT;).

**FRES < ON | OFF >;**  
Select frequency subset cal On/Off.

**FULP;**  
Select full page plot.

**FWDI;** Isolation  
**FWDM;** Load match  
**FWDT;** Tracking  
 Select forward transmission (S21) calibration standard class. Measure if single standard in class, or, if multiple standards in class, use **STAN** < char >; and **DONE**; to measure standards in class.

**GATECENT [value[time suffix]];**  
Set gate center.

**GATE < ON | OFF >;**  
Select gate off/on.

**GATESTAR [value[time suffix]];**  
**GATESPAN [value[time suffix]];**  
**GATESTOP [value[time suffix]];**  
 Set gate span, start, stop values.

**GATSMAXI;** Maximum  
**GATSMINI;** Minimum  
**GATSNORM;** Normal  
**GATSWIDE;** Wide  
 Select gate shape.

**GRAT;**  
Selects graticule parameter.

**GUIS;**  
Begin guided setup instructions.

**HARMOFF;** Second harmonic  
**HARMSEC;** Third harmonic  
**HARMTHIR;** Select harmonic measurement.

**HOLD;**  
Hold present measurement.  
Restart using **CONT**;

**IDN?;**  
Output ASCII instrument identification string. "HEW-LETT PACKARD, < model >, < op sys rev >"

**IFBW [value];**  
Select IF bandwidth.

**IFLCEQZE < 1-6 >;** Loop counter equals zero  
**IFLCNEZE < 1-6 >;** Loop counter does not equal zero  
**IFLTFAIL < 1-6 >;** Limit test fail  
**IFLTPASS < 1-6 >;** Limit test pass  
 Branch from executing test sequence to specified test sequence if condition is satisfied.

**IFPRTSWR;**  
Selects IF port match measurement parameter.

**IMAG;**  
Select display of Imaginary data using cartesian format for active channel.

**INCRLOOC;**  
Increment test sequence loop counter by one.

**INDEREFR;**  
Index of refraction.

**INID;**  
Initialize disc for instrument data storage.

## INPUCALC <01-12> to LIMISTIO

### INPUCALC <01-12>;

Store measurement calibration error coefficient set real/imaginary pairs input via HP-IB into instrument memory. Select appropriate cal type then input necessary coefficient sets (see **OUTPCALCn**;) then issue **SAVC**;. Issue **SING**; or **CONT**; to measure.

**INPUCALK**; Input cal kit, use **SAVEUSEK**;  
**INPUCALR**; Receiver cal data  
**INPUCALS**; Source cal data  
**INPU DATA**; Active channel corrected data  
**INPUFORM**; Active channel formatted data  
**INPULEAS**; Learn string  
**INPUPMCAL <1-2>**; Power meter calibration array  
**INPURAW <1-4>**; Active channel raw data array  
Input specified data via HP-IB.

**INSMEXSA**; External source, auto  
**INSMEXSM**; External source, manual  
**INSMNETA**; Standard analyzer  
**INSMTUNR**; Tuned receiver  
Select instrument mode.

**INTE [0-100]**;  
Set display intensity percent.

**ISOD**;  
Done with isolation part of 2-port cal.

**ISOL**;  
Begin isolation part of 2-port cal.

**KEY [keycode]**;  
Send keycode. See Keycode table.  
Equivalent to actually pressing a key.

**KITD**;  
Done with modify cal kit.  
Modified cal kit replaces existing kit.

**KOR?**;  
Output two byte key code or knob count.  
See Keycode table.  
Positive value = key code.  
Negative value can be converted to knob count.

**LABEFWDM ["string"]**; Forward match  
**LABEFWDT ["string"]**; Forward transmission  
**LABERESI ["string"]**; Response, Response & Isolation

**LABERESP ["string"]**; Response  
**LABEREVM ["string"]**; Reverse match  
**LABEREVT ["string"]**; Reverse transmission  
**LABES11A ["string"]**; S11A (opens)  
**LABES11B ["string"]**; S11B (shorts)  
**LABES11C ["string"]**; S11C (loads)  
**LABES22A ["string"]**; S22A (opens)  
**LABES22B ["string"]**; S22B (shorts)  
**LABES22C ["string"]**; S22C (loads)

**LABK ["string"]**; Electrical cal kit

**LABO ["string"]**; Optical cal kit  
Define cal kit label during modify cal kit.

**LABS ["string"]**;  
Define standard label during modify cal kit.

**LASEXT**;  
Select external laser.

**LASEINT**;  
Select internal laser.

**LASEOFF**;  
Laser off.

**LASEON**;  
Laser on.

**LEFL**; Left lower  
**LEFU**; Left upper  
Set plot quadrant option.

**LIMD [value]**;  
Set limit line delta value.

**LIMIAMP0 [value]**;  
Set limit line amplitude offset.

**LIMILINE < ON | OFF >**;  
Select limit line display.

**LIMIMAOF [value[suffix]]**;  
Marker to limit line stimulus offset.  
Center limit lines using active marker position and limit line amplitude offset.

**LIMISTIO [value[suffix]]**;  
Set limit line stimulus offset.

**LIMITEST <ON | OFF>;**

Select limit test.

**LIML** [value]; Lower limit

**LIMM** [value]; Middle limit

**LIMS** [value]; Stimulus break point limit

**LIMTFL**; Flat line

**LIMTSL**; Sloping line

**LIMTSP**; Single point

**LIMU** [value]; Upper limit

Define characteristics of limit test segment.

**LINFREQ;**

Select linear frequency sweep.

**LINM;**

Select cartesian Linear Magnitude format for active channel.

**LINTDATA** [value]; Data

**LINTMEMO** [value]; Memory  
Set line type plot options.

**LISFREQ;**

Select frequency list sweep mode.

**LISV;**

List data values to display.

**LOAD <1-5>;**

Recall specified disc file.  
Must pass control.

**LOADREC <1-5>;**

Load specified receiver cal data disc file.

**LOADSEQ <1-6>;**

Load specified test sequence disc data file.

**LOADSOU <1-5>;**

Load specified source cal data disc file.

**LOCNT;**

Selects external LO control

**LOFREQ;**

Selects frequency offset CW.

**LOFSTAR;**

Selects start frequency for frequency offset.

**LOFSTOP;**

Selects stop frequency for frequency offset.

**LOFSWE;**

Selects sweep frequency mode for frequency offset.

**LOGFREQ;**

Select log frequency sweep.

**LOGM;**

Select log magnitude display format for active channel.

**LOIFISOL;**

Selects LO to IF isolation measurement parameter.

**LOOC** [value];

Set value of test sequence loop counter.

**LOPOWER;**

Selects LO power level in frequency offset mode.

**LOPSTAR;**

Selects LO start power level in frequency offset mode.

**LOPSTOP;**

Selects LO stop power level in frequency offset mode.

**LOPSWE;**

Selects sweep power in frequency offset mode.

**LORFISOL;**

Selects LO to RF isolation measurement parameter.

**LOWPIMPU;** Impulse**LOWPSTEP;** Step

Select time domain stimulus model.

**LRN?;**

Output learn string.

**LWALCI <ON | OFF>;**

LW ALC IN : ON = EXT, OFF = INT;

**LWALCO <ON | OFF>;**

LW ALC on or off.

**LWALCV** [value];

Save value of LW ALC.

**MANTRIG;**

Select manual trigger.

**MARK <1-4>** [value[suffix]];

Select active marker.

Move it to specified stimulus value.

**MARKBUCK** [0-# of pts-1];

Move active marker to specified data point number.

**MARKCENT** [value[suffix]];

Move active marker to Center stimulus value.

## MARK < COUP | UNCO > to MEM1 |

### MARK < COUP | UNCO >;

Select Markers always coupled/uncoupled.  
Preset selects Coupled.

### MARKCW;

Change Center stimulus value to active marker stimulus value.

### MARKDELA;

Set electrical delay to balance phase at marker frequency.

Delay = zero seconds; flat phase at marker.

### MARK < DISC | CONT >;

Select Discrete (measured data points only), or Continuous (linear interpolation between actual data points), Preset selects Discrete.

### MARKFAUV [value[suffix]];

Set fixed marker auxiliary value offset.

### MARKFSTI [value[suffix]];

Set fixed marker stimulus offset value.

### MARKFVAL [value];

Set fixed marker position value offset.

### MARKMAXI;

Select Marker Search mode; execute search for maximum data value.

### MARKMIDD;

In limit table segment edit, change the segment middle value to the current marker amplitude.

### MARKMINI;

Select Marker Search mode; execute search for minimum data value.

### MARKOFF;

Select all markers and marker functions Off.

### MARKREF;

Change reference position value to current marker amplitude value.

### MARKSPAN;

Change stimulus span to current delta marker stimulus value.

### MARKSTAR;

Change stimulus start to current marker stimulus value.

### MARKSTIM;

In limit table segment edit, change the limit stimulus break point to the current marker stimulus value.

### MARKSTOP;

Change stimulus stop to current marker stimulus value.

### MARKZERO;

Fixed marker moves to current active marker position and becomes delta ref marker.

### MATI;

MATI to current memory.

### MAXF [value[freq suffix]];

Maximum frequency for current cal standard.

**MEASA;** Input A

**MEASB;** Input B

**MEASE01;** Transmission measurement E/O

**MEASE02;** Transmission measurement E/O (aux)

**MEASOE1;** Transmission measurement O/E (port 1)

**MEASOE2;** Transmission measurement O/E (port 2)

**MEASOFF;** Marker function measure off

**MEASR;** Input R

Select measurement for active channel.

### MEASSTAT < ON | OFF >;

Select trace statistics.

### MEASOO1;

Transmission measurement O/O.

### MEAS 002;

Transmission measurement O/O (aux).

### MEAS01;

Optical reflection measurement.

### MEAS02;

Optical reflection measurement (aux).

### MEMO1;

Display memory 1.

### MEMO2;

Display memory 2.

### MEM1I;

Memory 1 to memory 2.

**MEM2;**

Memory 2 to memory 1.

**MENUAVG;****MENUCAL;****MENUCOPY;****MENUDISP;****MENUFORM;****MENUMARK;****MENUMEAS;****MENUMRKF;****MENU < ON | OFF >;****MENURECA;****MENUSAVE;****MENUSCAL;****MENUSTIM;****MENUSYST;**

Display specified softkey menu.

**MINF [value[freq suffix]];**

Minimum frequency for current cal standard.

**MINU;**

Select display of complex data minus memory.

**MODB [value];**

Optical modulator bias.

**MODEI;**

Model to memory.

**MODI1;**

Modify current electrical cal kit.

**MODIO;**

Modify current optical cal kit.

**MOD RF < ON | OFF >;**

Optical modulator RF input: ON = ext, OFF = int.

**NEWSE < 1-6 >;**

Modify specified test sequence.

**NEXP;**

Display next page of operating parameters list.

**NOOP;**

No Operation.

Sets Operation Complete status bit.

**NUMG [value];**

Restart averaging, execute the specified number of groups of sweeps, then hold.

**NUMR [value];**

Set number of power meter readings per point during cal.

**OFSD [value[time suffix]];** Electrical delay

**OFSL [value];** Electrical loss

**OFSOINDR [value];** Optical refractive index

**OFSOLENG [value];** Physical length

**OFSOLOSS [value];** Optical loss

**OFSORPOW [value];** Percent reflectance

**OFSZ [value];** Electrical offset line Z0.

Specify offset characteristics of current cal standard.

**OMII;**

Omit isolation part of cal.

**OPC[?];**

Operation complete.

If ?, send "1" when following command is complete.

**OPEP;**

Display operating parameters list.

**OPTA [value];**

Set optical attenuator.

## OUTPACTI to PHAS

<b>OUTPACTI;</b>	Active function value.	<b>OUTPRAW</b>	
<b>OUTPAFR;</b>	Signal Processor RF frequency	<b>&lt;1-4&gt;;</b>	Current raw data
<b>OUTPAPER;</b>	Smoothing aperture, stimulus unirs.	<b>OUTPRFFR;</b>	External source frequency
<b>OUTPCALC</b>		<b>OUTPSEQ</b>	
<b>&lt;01-12&gt;;</b>	Active cal set array	<b>&lt;1-6&gt;;</b>	Specified test sequence
<b>OUTPICAL</b>		<b>OUTPSTAT;</b>	Status byte (FORM4)
<b>&lt;01-12&gt;;</b>	Active interpolated cal set array	<b>OUTPTESS;</b>	Test status
<b>OUTPCALK;</b>	Current cal kit (Form1)	<b>OUTPTITL;</b>	Display title (FORM4)
<b>OUTPCALR;</b>	Receiver cal data	<b>OUTPTPLL;</b>	True pll sequence
<b>OUTPCALS;</b>	Source cal data		Output specified data via HP-IB.
<b>OUTPCNTR;</b>	Service, abus counter.	<b>PAUS;</b>	
<b>OUTPDATA;</b>	Active channel corrected data		Pause in test sequence.
<b>OUTPERRO;</b>	Error message (ASCII #,"string")	<b>PCB [value];</b>	
<b>OUTPFORM;</b>	Active channel formatted data		Pass Control Back address.
<b>OUTPIDEN;</b>	Instrument id string (see IDN?;)		See ADDRCONT;.
<b>OUTPIPMCL &lt;1   2&gt;;</b>		<b>PDATA &lt;ON   OFF&gt;;</b>	
	Active interpolated power meter cal array.		Select data trace plot option.
<b>OUTPKEY;</b>	Last key pressed (Keycode table)	<b>PEEK;</b>	
<b>OUTPLEAS;</b>	Instrument learn string (Form1)		PEEL <memory address >;
<b>OUTPLIMF;</b>	Limit test, failed point		Peek/Poke location.
<b>OUTPLIML;</b>	Limit test, each point		Service use only.
<b>OUTPLIMM;</b>	Limit test, marker position	<b>PENNDATA [value];</b>	Data trace, limit lines
<b>OUTPMARK;</b>	Active marker (x,y,stimulus)	<b>PENNGRAT [value];</b>	Graticule
<b>OUTPMPUL;</b>	Current memory data	<b>PENNMARK [value];</b>	Markers and marker text
<b>OUTPMEMO;</b>	Pulse width (x,y,duty cycle)	<b>PENNMEMO [value];</b>	Memory trace
<b>OUTPMRIS;</b>	Rise time (x,y,z)	<b>PENNTXT [value];</b>	Text and User graphics
<b>OUTPMSTA;</b>	Marker stats (mean, std dev, p-p)		Define plotter pen color for portion of plot.
<b>OUTPMUPL;</b>	Output pulsewidth	<b>PGRAT &lt;ON   OFF &gt;;</b>	
<b>OUTPMWID;</b>	Bandwidth search (bw, center, Q)		Select graticule plot option.
<b>OUTPMWIL;</b>	Band search (bw,center,Q,loss)	<b>PHAO [value];</b>	
<b>OUTPOPTS;</b>	Service, option sum		Set phase offset.
<b>OUTPPLOT;</b>	HP-GL plot string	<b>PHAS;</b>	
<b>OUTPPMCAL</b>			Select cartesian phase format for active channel.
<b>&lt;1   2&gt;;</b>	Power meter cal, Channel		
<b>OUTPPRIN;</b>	Raster dump to printer		
<b>OUTPRAF &lt;1 - 4&gt;;</b>			
	Current raw data.		

**PLOS<FAST | SLOW>;**

Select plotter pen speed.  
Preset selects fast.

**PLOT;**

Request a plot.  
Requires pass control mode.

**PMEM<ON | OFF>;**

Select memory trace plot option.

**PMKR<ON | OFF>;**

Select marker and marker text plot option.

**PMTRTTIT;**

In test sequence, read power meter/HP-IB value into title string.

**POIN [value];**

Define number of points in current frequency list segment.

**POKE value;**

Change contents of memory location.  
Service use only.

**POLA;**

Select Polar display format for active channel.

**POLMLIN;**     lin mag, phase

**POLMLOG;**     log mag, phase

**POLMRI;**     real, imaginary

Select polar format marker units.

**PORE<ON | OFF>;** Select Port Extensions On/Off.

NUMR [value]PORE<ON | OFF> PORT1 [value[time suffix]];

**PORT1 [value[time suffix]];**

**PORT2 [value[time suffix]];**

**PORTA [value[time suffix]];**

**PORTB [value[time suffix]];**

Set port extensions electrical delay.

**PORTR [value[time suffix]];**     Reflection

**PORTT [value[time suffix]];**     Transmission

Set port extensions electrical delay

**POWE [value];**

Set source output level (dBm).

**POWLFREQ [value[freq suffix]];**

Define current frequency in the power loss list.

**POWLLIST;**

Begin power loss list edit for power meter cal.

**POWLOSS [value];**

Set the power loss value for the current frequency in the power loss list.

**POWM<ON | OFF>;**

Selects that HP 436 (On) or HP 438 (Off) is used in service procedures.

**POWOM<ON | OFF>;**

Select guided setup instructions at instrument power up.

**POWS<ON | OFF>;**

Select Power sweep mode.

**POWT<ON | OFF>;**

Set Power Trip Off, then On to clear port input power overload condition.

**PRES;**

Instrument Preset.

**PRIC;**

Select color print.

**PRINALL;**

Copy measurement display to printer according to plot options.

**PRINSEQ<1-6>;**

Print specified test sequence.

**PRIS;**

Select standard print.

**PSOFT<ON | OFF>;**

Select plot softkey labels option.

**PTEXT<ON | OFF>;**

Select plot text option.

**PTOS;**

Pauses for selection of available sequences.

**PULV [value];**

Set pulse width search value.

**PULW<ON | OFF>;**

Select pulse width search Off/On.

**PURG<1-5>;**

Purge specified file from disc.  
Requires pass control.

## PWMCEACS to RSCO

**PWMCEACS;** Cal each sweep; no cal sweep  
**PWMCOFF;** Correction Off  
**PWMCONES;** One sweep cal; use cal sweep  
Select power meter cal.  
Preset selects Off.

**PWRLOSS < ON | OFF >;**  
Select power loss table.  
Preset selects Off.

**RAID;**  
Done with Response and Isolation cal. If all necessary standard classes have been measured, a cal set is created.

**RAISOL;**  
Measure Isolation standard in Response & Isolation cal.

**RAIRESP;**  
Measure Response standard in Response & Isolation cal.

**RAMD;**  
Response and match cal done.

**READRECT;** Receiver  
**READSOUT;** Source  
Read disc electro-optical cal data file titles.

**REAL;**  
Select Real cartesian format for active channel.

**RECA < 1-5 >;**  
Recall the specified instrument state.

**RECCSTDI;** Current coefficients  
**RECDSTDI;** Load from disk.  
Select receiver model.

**RECEOUT < ON | OFF >;**  
Select path to receiver output; ON = CAL, OFF = OPT.

**RECO;**  
Recall colors.

**REFD;**  
Done with Reflection part of Full 2-port cal.

**REFL;**  
Begin Reflection part of Full 2-port cal.

**REFP [value];**  
Set Reference Position Line graticule.  
0 = bottom; 10 = top.

**REFT;**  
Recall register titles from disk.  
Requires pass control mode.

**REFV [value];**  
Set current format reference position line value.

**RESC;**  
Resume last measurement calibration sequence.

**RESD;**  
Restore measurement display.

**RESM;**  
Reset mode 1.

**RESPDONE;**  
Finished with Response cal. If all necessary standards are measured, a cal set will be created.

**REST;**  
Measurement restart.

**REVI;** Isolation  
**REVM;** Load match  
**REVT;** Tracking  
Select reverse transmission (S12) calibration standard class. Measure if single standard in class, or, if multiple standards in class, use **STAN < char >;** and **DONE;** to measure standards in class.

**RFIFISOL;**  
Selects RF to IF isolation measurement parameter.

**RFLP;**  
Select reflection port.

**RFLTLO;**  
Selects RF less than LO.

**RFGTLO;**  
Selects RF greater than LO.

**RFPRTSWR;**  
Selects RF port match measurement parameter.

**RIGL;** Right Lower  
**RIGU;** Right Upper  
Select plot quadrant.

**RIST < ON | OFF >;**  
Select rise time search Off/On.

**RSCO;**  
Reset color.



- RST;**  
Instrument Preset.
- S11;**  
**S12;**  
**S21;**  
**S22;**  
Select parameter displayed on current active channel.
- SADD;**  
Add a segment to current frequency list or limit table.
- SAMC < ON | OFF >;**  
Select internal sampler correction Off/On.  
Preset selects On.
- SAV1;**  
Finished with 1-port cal. If all necessary standards are measured, a 1-port cal set is created.
- SAV2;**  
Finished with 2=Port cal. If all necessary standards are measured, a 2-port cal set is created.
- SAVC;**  
Create a cal set using current error coefficient arrays.
- SAVE < 1-5 >;**  
Save the current instrument state in specified register.
- SAVEOPTK;**  
Save active optical cal kit as optical user cal kit.
- SAVERECC;**           Receiver  
**SAVESOUC;**           Source  
Store current electro-optical coefficients.
- SAVEUSEK;**  
Store the active calibration kit as the User kit.
- SAVUASCI;**           Save using CITIFile ASCII  
**SAVUBINA;**           Save using binary  
Select disc file format.  
See Disc File Name table.
- SCAL [value];**  
Set graticule x-axis or polar scale/division for current format.
- SCAPFULL;**           Full plot.  
**SCAPGRAT;**           Expand to P1 and P2.  
Select plot option.
- SDEL;**  
Delete current frequency list segment or limit table segment.
- SDON;**  
Done with current frequency list segment or limit table segment, include segment in list.
- SEAL;**           Search Left  
**SEAR;**           Search Right  
Initiate marker search left or right from current position for selected Min, Max, or Target. Message if not found.
- SEAMAX;**           Search for Maximum  
**SEAMIN;**           Search for Minimum  
**SEAOFF;**           Search Mode Off  
**SEATARG [value];** Search for target.  
Select Marker Search mode; execute search.
- SEDI [value];**  
Edit current or specified frequency list segment.
- SEQ < 1 - 6 >;**  
Selects specified sequence for test.
- SEQWAIT [value];**  
In test sequence, wait integer seconds.
- SETF;**  
Set harmonic frequency steps for time domain low pass transform.
- SETZ;**  
Define Z0 of Smith Chart, Inverted Smith, Load cal standard type, **CONVZ;** and **CONV;**  
Preset selects Z0=50 ohms.
- SHOM;**  
In test sequence, show menu.
- SING;**  
Single sweep or set of sweeps, then hold.
- SLID;**  
Sliding load done.
- SLIL;**  
Define load standard type as sliding.
- SLIS;**  
Slide is set; measure sliding load.  
**RESMSLIS SLOPE [value];**  
Enter power slope value (dB/GHz)

## SLOPE to STDD

**SLOPE** [value];

Enter power slope value (dB/GHz).

**SLOP** < ON | OFF >;

Select power slope Off/On.

**SLOW**;

Selects slow plot speed.

**SM** < 1-8 >

**SM2** < D,E,H,L, or M >;

Service, source control.

**SMIC**;

Select Smith chart display format for current channel.

**SMIMGB**;  $G \pm jB$

**SMIMLIN**; linear magnitude, phase angle

**SMIMLOG**;  $20\log_{10}(\text{linear mag})$ , phase angle

**SMIMRI**; real/imaginary pair

**SMIMRX**;  $R \pm jX$

Select Smith chart marker readout format.

**SMOOAPER** [0.1-20]; Smoothing aperture

**SMOOOFF**; Smoothing Off

**SMOOON** [0.1-20]; Smoothing On

Control smoothing for selected channel.

value=percent of span: 0.1, 0.2, 0.5,...20 sequence.

**SOFR**;

Display instrument operating system revision.

**SOFT** < 1-8 >;

Select the softkey function for the current displayed menu.

**SOUCASTDI**; Current coefficients

**SOUASTDI**; Load from disc.

Select source model.

**SPAN** [value[suffix]];

Set stimulus span.

**SPAR** < ON | OFF >;

S-parameter notation On/Off.

**SPECFWDM** stanAno[,stanBno...[stanGno]];

**SPECFWDT** stanAno[,stanBno...[stanGno]];

**SPECRESI** stanAno[,stanBno...[stanGno]];

**SPECRESP** stanAno[,stanBno...[stanGno]];

**SPECREVM** stanAno[,stanBno...[stanGno]];

**SPECREVT** stanAno[,stanBno...[stanGno]];

**SPECS11A** stanAno[,stanBno...[stanGno]];

**SPECS11B** stanAno[,stanBno...[stanGno]];

**SPECS11C** stanAno[,stanBno...[stanGno]];

**SPECS22A** stanAno[,stanBno...[stanGno]];

**SPECS22B** stanAno[,stanBno...[stanGno]];

**SPECS22C** stanAno[,stanBno...[stanGno]];

Specify from 1 to 7 standards in each calibration standard class.

StanAno = first standard in class,

StanGno = last standard in class.

**SPEG** < ON | OFF >;

Select gate markers.

**SPLD** < ON | OFF >;

Select split display On/Off.

**SRE** [value];

Service request enable. (0-256)

Value defines bits enabled to generate SRQ.

**SSEG** [value];

Measure specified single segment of frequency list.

**STAF** [value[freq suffix]];

Set start frequency with transform On.

**STAN** < A-G >;

Measure cal standard in current standard class.

**STAR** [value[suffix]];

Set Start stimulus value.

**STB?**;

Output status byte.

**STDD**;

Done with current standard definition.

**STDODEFI;**  
Done with optical cal standards.

**STDTARBI;** 1-port arbitrary impedance  
**STDDELA;** Delay/Thru 2-port  
**STDTFRES;** Fresnel  
**STDLOAD;** 1-port Z0 load  
**STDOPEN;** Open circuit  
**STDOTHR;** Thru  
**STDRECE;** Receiver  
**STDREFL;** Reflector  
**STDTSOR;** Short circuit  
**STDTSOUR;** Source  
**STDTHRR;** Thru/receiver  
Define current standard type.

**STOP [value[suffix]];**  
Set Stop stimulus value.

**STOR < 1-5 >;**  
Store file to disc.

**STORSEQ < 1-6 >;**  
Store specified test sequence.

**STPSIZE [value[freq suffix]];**  
Define current frequency list segment step size.

**SVCO;**  
Save colors.

**SWEA;**  
Select sweep time, auto.

**SWET [value[time suffix]];**  
Set sweep time.

**SWR;**  
Select SWR display for active channel.

**TAKCS;**  
Begin power meter calibration sweep.

**TALKLIST;**  
Set instrument to talker/listener mode.

**TERI [value];**  
Define real terminal impedance of arbitrary impedance standard.

**TESR < 1,2,4,6,or 8 >;**  
Service, send test response.

**TESS?;**  
Return "1" if S-parameter test set.  
Return "2" if doubler test set.

**TEST [value];**  
Service, select test.

**TIMDTRAN < ON | OFF >;**  
Select time domain transform On/Off.

**TINT [0-100];**  
Set color hue  
(0 = red, 100 = violet).

**TITF < 1-5 > ["string"];** Disk file.  
**TITL ["string"];** CRT title.  
**TITR < 1-5 > ["string"];** Save/recall register.  
**TITSEQ < 1-6 > ["string"];** Test sequence.  
**TITSQ ["string"];** Current test sequence.  
**TITMEM ["string"];** Trace memory.  
**TITPMTR ["string"];** Power meter address  
**TITPRIN ["string"];** printer address  
Send title string to specified function.

**TO < 1-2 > < ON | OFF >;**  
Service, test record option.

**TRACK < ON | OFF >;**  
Select marker search tracking Off/On.

**TRAD;**  
Done with transmission part of Full 2-port cal.

**TRAN;**  
Begin transmission part of Full 2-port cal.

**TRAP;**  
Display transform parameters.

**TRAS [value[freq suffix]];**  
Enter new frequency span with transform On.

**TRIG;**  
Select HP-IB triggered data acquisition.  
Instrument does Hold, sets status bit, then wait for HP-IB Group Execute Trigger for next measurement step, executes trigger, then sets status bit.  
Exit using **FRER;**, **CONT;**, or **PRES;**.

**TST?;**  
Initiate self-test sequence;  
Return zero if pass.

## TTLOH to WRSK <1-8>

**TTLOH;** High  
**TTLOL;** Low  
Defines active level of test set TTL output.

**UCONV;**  
Selects upconverter.

**UP;**  
Increment current active function value.

**USEPASC;**  
Instrument enters pass control mode.

**USESENSA;**

**USESENSB;**  
Sensor A  
Sensor B  
Select power sensor.

**VELOFACT** [value];  
Define velocity factor of transmission medium.

**VIEM;**  
Selects view measure, which displays frequency offset configuration.

**VOFF** [value];  
Define frequency offset value.

**WAIT;**  
Wait for a clean sweep.

**WAVE;**  
Define cal standard as Waveguide (dispersive) phase).  
Standard rectangular waveguide,

**MAXF;** sets cutoff frequency.

**WAVL 1300;**  
Optical wavelength is 1300 nm..

**WAVL 1550;**  
Optical wavelength is 1550 nm.

**WIDT < ON | OFF >;**  
Select bandwidth search On/Off.

**WIDV** [value];  
Define bandwidth search value in current format.

**WINDMAXI;** Maximum window  
**WINDMINI;** Minimum window  
**WINDNORM;** Normal window  
**WINDOW** [value]; Arbitrary window  
**WINDUSEMOFF;** Above commands define window  
**WINDUSEMON;** Trace memory defines window  
Select time domain window shape.

**WRSK < 1-8 > ["string"];**  
Enter new softkey label.

## List of OPC'able Codes

The Operation Complete (OPC) function allows synchronization of the program by causing a specific action when the current command has completed executing, before the next command begins executing. There are two forms for this process. The function is enabled by issuing **OPC**; or **OPC?**; prior to an OPC'able command. An example of this usage is **OPC; PRES;**. In this instance, the Operation Complete bit is automatically set when the Preset command has completed execution. Issuing **OPC?**; prior to the command causes the instrument to set the Operation Complete status bit then output a "1" when the command has completed execution.

Following is an alphabetical list of OPC'able commands.

<b>ADJB;</b>	<b>MATI;</b>
<b>CHAN1;</b>	<b>MEM1I;</b>
<b>CHAN2;</b>	<b>MEM2I;</b>
<b>CLEARALL;</b>	<b>MODEI;</b>
<b>DATI;</b>	<b>NOOP;</b>
<b>DONE;</b>	<b>NUMG;</b>
<b>DON &lt; A,B,AR,BR &gt; CAL;</b>	<b>PRES;</b>
<b>EDITDONE;</b>	<b>RAID;</b>
<b>EXTTOFF;</b>	<b>RECA &lt; 1-5 &gt;;</b>
<b>EXTTPOIN;</b>	<b>REFD;</b>
<b>FREQOFFS &lt; ON   OFF &gt;;</b>	<b>RESPDONE;</b>
<b>FREQRANG &lt; 3GHZ   6GHZ &gt;;</b>	<b>RST;</b>
<b>HARMOFF;</b>	<b>SAV1;</b>
<b>HARMSEC;</b>	<b>SAV2;</b>
<b>HARMTHIR;</b>	<b>SAVC;</b>
<b>INSMEXSA;</b>	<b>SAVE &lt; 1-5 &gt;;</b>
<b>INSMEXSM;</b>	<b>SING;</b>
<b>INSMNETA;</b>	<b>STAN &lt; A-G &gt;;</b>
<b>INSMTUNR;</b>	<b>TRAD;</b>
<b>ISOD;</b>	<b>WAIT;</b>
<b>MANTRIG;</b>	

## Interrgate Instrument State (Query) Commands

All instrument functions can be interrogated to find the current On/Off state or value.

For instrument state commands, append the question mark (?) character instead of **< ON | OFF >** to interrogate the state of the functions. An example is **AVER?;**. The analyzer responds to the next controller Enter operation with a "1" or a "0" to indicate On or Off, respectively.

For settable functions such as **SCAL [value];**, using **SCAL?;** causes the analyzer to respond to the next controller enter operation by outputting the current function value then clearing the instrument entry area.

If a command that does not have a defined response is interrogated, the instrument outputs a zero.

**For more information, call your local HP sales office listed in your telephone directory or an HP regional office listed below for the location of your nearest sales office.**

**United States:**

Hewlett-Packard Company  
4 Choke Cherry Road  
Rockville, MD 20850  
(301) 670-4300

Hewlett-Packard Company  
5201 Tollview Drive  
Rolling Meadows, IL 60008  
(312) 255-9800

Hewlett-Packard Company  
5161 Lankershim Blvd.  
No. Hollywood, CA 91601  
(818) 505-5600

Hewlett-Packard Company  
2015 South Park Place  
Atlanta, GA 30339  
(404) 955-1500

**Canada:**

Hewlett-Packard Ltd.  
6877 Goreway Drive  
Mississauga, Ontario L4V1M8  
(416) 678-9430

**Australia/New Zealand:**

Hewlett-Packard Australia Ltd.  
31-41 Joseph Street,  
Blackburn, Victoria 3130  
Melbourne, Australia  
(03) 895-2895

**Europe/Africa/Middle East:**

Hewlett-Packard S.A.  
Central Mailing Department,  
P.O. Box 529  
1180 AM Amstelveen,  
The Netherlands  
(31) 20/547 9999

**Far East:**

Hewlett-Packard Asia Ltd.  
22/F Bond Centre  
West Tower  
89 Queensway  
Central, Hong Kong  
(5) 8487777

**Japan:**

Yokogawa-Hewlett-Packard Ltd.  
29-21, Takaido-Higashi 3-chome  
Suginami-ku, Tokyo 168  
(03) 331-6111

**Latin America:**

Latin American Region Headquarters  
Monte Pelvoux Nbr. 111  
Lomas de Chapultepec  
11000 Mexico, D.F. Mexico  
(905) 596-79-33

**January 15, 1992**

Copyright ©1989  
Hewlett-Packard Company  
Printed in U.S.A.



# Chapter 4. System Overview

## CHAPTER CONTENTS

- 4-1 System Overview
- 4-2 Data Processing

## SYSTEM OVERVIEW

Network analyzers measure the reflection and transmission characteristics of devices and networks by applying a known swept signal and measuring the responses of the test device. The signal transmitted through the device or reflected from its input is compared with the incident signal generated by a swept RF source. The signals are applied to a receiver for measurement, signal processing, and display. A network analyzer system consists of a source, a signal separation device, a receiver, and a display.

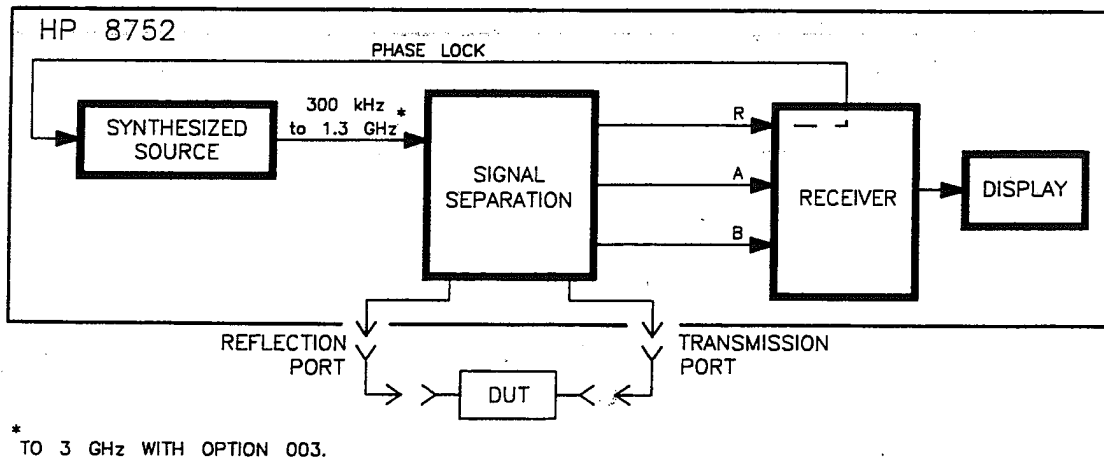

Figure 4-1. Simplified Block Diagram of the Network Analyzer System

## Overall Operation

The source RF signal is transmitted through the device under test (DUT) and is then applied to the B input of the receiver. The portion of the signal that reflects off the DUT's input port is coupled off to the receiver's A input. The A and B inputs are compared to the original signal at the R input to characterize transmission and reflection responses of the DUT.

## The Built-In Synthesized Source

The built-in synthesized source produces a swept RF signal in the range of 300 kHz to 1300 MHz (up to 3.0 GHz with option 003). The RF output power is leveled by an internal ALC (automatic leveling control) circuit. To achieve frequency accuracy and phase measuring capability, the analyzer is phase locked to a highly stable crystal oscillator. For this purpose, a portion of the transmitted signal is routed via the built-in coupler to the R input of the receiver, where it is sampled by the phase detection loop and fed back to the source.

## The Receiver Block

The receiver block contains three identical sampler/mixers for the R, A, and B inputs. The signals are sampled, and mixed to produce a 4 kHz IF (intermediate frequency). A multiplexer sequentially directs each of the three signals to the ADC (analog to digital converter) where it is converted from an analog to a digital signal to be measured and processed for display. Both amplitude and phase information are measured simultaneously, regardless of what is displayed.

**The Microprocessor.** A microprocessor takes the raw data and performs all the required error correction, trace math, formatting, scaling, and marker operations, according to the instructions from the front panel. The formatted data is then displayed. The data processing sequence is described below.

## Calibration Standards

A measurement may require calibration standards for vector accuracy enhancement. Model numbers and details of compatible calibration kits are provided in Chapter 1, "General Information".

# DATA PROCESSING

## Overview

The receiver converts the R, A, and B input signals into useful measurement information. This conversion occurs in two main steps. First, the swept high frequency input signals are translated to fixed low frequency IF signals, using analog sampling and/or mixing techniques. (Refer to "Theory of Operation" in the *Service Manual* for details.) Second, the IF signals are converted into digital data by an analog-to-digital converter (ADC). From this point on, all further signal processing is performed mathematically by a microprocessor. The following paragraphs describe the sequence of math operations and the resulting data arrays as the information flows from the ADC to the display. They provide a good foundation for understanding most of the response functions, and the order in which they are performed. The data arrays mentioned contain measurement data in different states of processing. These arrays can be stored to external disk, or output to a computer over HP-IB.

Figure 4-2 is a data processing flow diagram that represents the flow of numerical data from IF detection to display. The data passes through several math operations, denoted in the figure by single-line boxes. Most of these operations can be selected and controlled with the front panel RESPONSE block menus. The data is also stored in arrays along the way, denoted by double-line boxes.



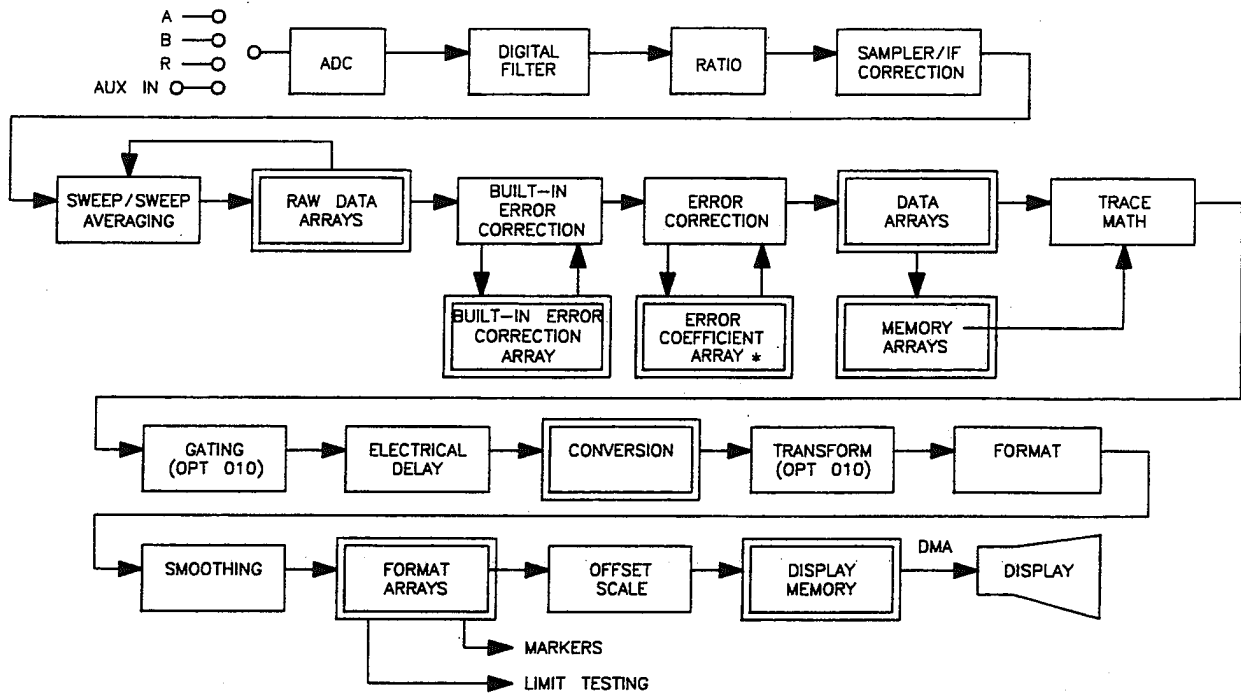

\* CALLED "DATA ARRAY" IN THE DEFINE STORE MENU.

Figure 4-2. Data Processing Flow Diagram

## Channel 1 and 2 Have Independent Data Processing Paths

While only a single flow path is shown, two identical paths are used, corresponding to channel 1 and channel 2. When the channels are uncoupled, each channel can be independently controlled, so that the data processing operations for one are different from the other.

### Important Concepts

*Stimulus* is whatever is being measured on the display x-axis (frequency, power, or time).

A *data point* or *point* is a single piece of data representing a measurement at a single stimulus value. Most data processing operations are performed point-by-point; some involve more than one point.

A *sweep* is a series of consecutive data point measurements, taken over a sequence of stimulus values. A few data processing operations require that a full sweep of data is available. The number of points per sweep can be defined by the user. Note that the meaning of the stimulus values (independent variables) can change, depending on the *sweep type* although this does not generally affect the data processing path. Examples of sweep types are linear frequency, logarithmic frequency, power sweep, or CW time sweep. Frequency list mode is the last sweep type, it allows you to choose specific stimulus points to be measured.

## Processing Details

**The ADC.** The ADC converts the R, A, and B inputs (already down-converted to a fixed low frequency IF) into digital words. (The AUX INPUT connector on the rear panel is a fourth input.) The ADC switches rapidly between these inputs, so they are converted nearly simultaneously. (Refer to "[MEAS] Key" in Chapter 7 for more information on inputs.)

**IF Detection (digital filter block).** IF detection occurs in the digital filter, which performs the discrete Fourier transform (DFT) on the digital words. The samples are converted into complex number pairs (real plus imaginary,  $R + jX$ ). The complex numbers represent both the magnitude and phase of the IF signal. If the AUXILIARY INPUT is selected, the imaginary part of the pair is set to zero. The DFT filter shape can be altered by changing the IF bandwidth, which is a highly effective technique for noise reduction. (Refer to the *User's Guide* for information on different noise reduction techniques.)

**Ratio Calculations.** These are complex (phase and magnitude) divide operations. The R, A, and B values are also split into channel data at this point. (Refer to "[MEAS] Key" in Chapter 7 for more information.)

**Sampler/IF Correction.** The next digital processing technique used is IF correction. This process digitally corrects for IF errors (both magnitude and phase) in the analog down-conversion path.

**Sweep-to-sweep Averaging.** This is another noise reduction technique, and involves taking the complex exponential average of several consecutive sweeps. (Refer to "[AVG] Key" in Chapter 7.)

**Raw Data Arrays.** These store the results of all the preceding data processing operations. (Up to this point, all processing is performed real-time with the sweep by the IF processor. The remaining operations are not necessarily synchronized with the sweep, and are performed by the main processor.) The only user-selected feature that affects the raw data array is averaging. When the channels are uncoupled (coupled channels off), two raw arrays may exist. The numbers in the raw data arrays are complex pairs. Raw data arrays can be saved to disk, or transferred to another computer over HP-IB.

**Built-in Error Correction.** This instrument contains a built-in error correction feature. Built-in error correction removes repeatable systematic errors (frequency response, source match, and directivity errors) caused by the built-in coupler, RF connectors, and supplied cable. This feature is automatic, and cannot be turned off. The *User's Guide* explains when the built-in error correction is valid, and when it must be supplemented with a user-performed measurement calibration (explained below). The information from the raw array is used to create the built-in correction array. This array is not available over HP-IB, and it cannot be saved to disk.

**User-Performed Measurement Calibration (Vector Error Correction/Accuracy Enhancement).** If the operator has performed a measurement calibration, and correction is turned on, the analyzer performs this data processing step. This form of error correction removes repeatable systematic errors caused by adapters, extra test cables, or external test equipment. It is also used when measuring devices with other than nominal impedance. The user-performed measurement calibration data is stored in the error coefficient arrays. The data from the built-in correction arrays is used to create the error coefficient arrays (refer to "Measurement Calibration" in Chapter 7 for details.) These are subsequently used whenever correction is on, and are accessible via HP-IB. Error coefficient arrays can also be stored to disk.

The results of error correction are stored in the data arrays as complex number pairs.

If the data-to-memory operation is performed, the data arrays are copied into the memory arrays. (Refer to "[DISPLAY] Key" in Chapter 7.)

**Trace Math Operation.** This selects either the data array, memory array, or both to continue flowing through the data processing path. In addition, the complex ratio of the two (data/memory) or the difference (data – memory) can also be selected. If memory is displayed, the data from the memory arrays goes through exactly the same data processing flow path as the data from the data arrays. (Refer to “[DISPLAY] Key” in Chapter 7 for information on memory math functions.)

**Gating.** This is a digital filtering operation associated with time domain transformation (option 010 only). Its purpose is to mathematically remove unwanted responses isolated in time. In the time domain, this can be viewed as a time-selective bandpass or band-stop filter. (If both data and memory are displayed, gating is applied to the memory trace only if gating was on when data was stored into memory.) Refer to “Time Domain” for details.

**Electrical Delay.** This involves adding or subtracting phase in proportion to frequency. This is equivalent to “line-stretching” or artificially moving the measurement reference plane. (Refer to “[ELECTRICAL DELAY]” under “[SCALE/REF] Key” in Chapter 7 for detailed information. For an example of use, refer to the example measurements portion of the *User’s Guide*.)

**Conversion Transforms.** This transforms the measured data to the equivalent complex impedance (Z) or admittance (Y) values, or to inverted data format (1/S). (Refer to “Conversion Menu” under “[MEAS] Key” in Chapter 7.)

**Windowing.** This is a digital filtering operation that prepares (enhances) the frequency domain data for transformation to time domain. (Refer to “Time Domain” for details.)

**Time Domain Transform.** This converts frequency domain information into the time domain when transform is on (option 010 only). The results resemble time domain reflectometry (TDR) or impulse-response measurements. The transform employs the chirp-Z inverse fast Fourier transform (FFT) algorithm to accomplish the conversion. The windowing operation, if enabled, is performed on the frequency domain data just before the transform. (A special transform mode is available to “demodulate” CW sweep data, with time as the stimulus parameter, and display spectral information with frequency as the stimulus parameter.) Refer to the time domain section for details.

**Formatting.** This converts the complex number pairs into a scalar representation for display, according to the selected format. This includes group delay calculations. These formats are often easier to interpret than the complex number representation. (Polar and Smith chart formats are not affected by the scalar formatting.) Note that after formatting, it is impossible to recover the complex data. (Refer to “[FORMAT] Key” in Chapter 7 for information on the different formats available and on group delay principles.)

**Smoothing.** This is another noise reduction technique, that smoothes noise on the trace. When smoothing is on, each point in a sweep is replaced by the moving average value of several adjacent (formatted) points. The number of points included depends on the smoothing aperture, which can be selected by the user. The effect is similar to video filtering. If data and memory are displayed, smoothing is performed on the memory trace only if smoothing was on when data was stored into memory. (Refer to “[AVG] Key” in Chapter 7 for information about smoothing.)

**Format Arrays.** The results so far are stored in the format arrays. It is important to note that marker values and marker functions are all derived from the format arrays. Limit testing is also performed on the formatted data. Format arrays contain scalar (magnitude) data only, not complex (magnitude and phase) data. Phase data cannot be calculated from the format data. Format arrays are accessible via HP-IB, and may be saved to disk.

**Offset and Scale.** These operations prepare the formatted data for display. This is where the reference line position, reference line value, and scale calculations are performed, as appropriate to the format. (Refer to “[SCALE/REF] Key” in Chapter 7.)

**Display Memory.** The display memory stores the display image for presentation on the display. The information here includes graticules, annotation, and softkey labels – everything visible on the display. If user display graphics are written, these are also stored in display memory. When you print or plot a copy of the display, the information sent to the plotter or printer is taken from display memory.

Finally, the display memory data is sent to the display. The display is updated (refreshed) frequently and asynchronously with the data processing operations, to provide a flicker-free image.

# Chapter 5. Front and Rear Panel

---

## CHAPTER CONTENTS

- 5-1 Introduction
- 5-1 Active Function
- 5-1 Front Panel Keys and Softkey Menus
- 5-4 Front Panel Features
- 5-6 Display
- 5-7 Status Notations
- 5-8 Rear Panel Features and Connections

## INTRODUCTION

This chapter describes how to operate the analyzer using front panel controls, and explains the use of softkey menus. It provides illustrations and descriptions of the front panel features, the display and its labels, and the rear panel features and connectors.

Functions of the analyzer are activated from the front panel by the operator using front panel keys or softkeys. (In this manual, all front panel keys and softkey labels are shown in brackets. Front panel keys are shown in bold print, softkeys are shown in italics.)

## ACTIVE FUNCTION

The function currently activated is called the active function, and is displayed in the active entry area at the upper left of the display. As long as a function is active it can be modified with the ENTRY keypad (refer to Figure 5-1). A function remains active until another function is selected, or [ENTRY OFF] is pressed.

## FRONT PANEL KEYS AND SOFTKEY MENUS

Some of the front panel keys change instrument functions directly, and others provide access to additional functions available in softkey menus. Softkey menus are lists of up to eight related functions that can be displayed in the softkey label area at the right-hand side of the display. The eight keys to the right of the display are the softkeys. Pressing one of the softkeys selects the adjacent menu function. This either executes the labeled function and makes it the active function, or causes instrument status information to be displayed, or presents another softkey menu.

Some of the analyzer's menus are accessed directly from front panel keys, and some from other menus. For example, the stimulus menu accessed by pressing the [MENU] key presents all the stimulus functions such as sweep type, number of points, power, sweep time, and trigger. Pressing [SWEEP TYPE] presents another menu for defining sweep type parameters, while pressing [SWEEP TIME] allows the required sweep time to be entered directly from the number pad. [RETURN] takes you to the previous menu, while [DONE] is used both to indicate completion of a specific procedure and to return to the previous menu.

Usually, whenever a menu changes, the present active function is cleared, unless it is an active marker function.

## Why Some Softkeys are Joined by Vertical Lines

In cases where several possible choices are available for a function, they are joined by vertical lines. When a selection has been made from the listed alternatives, that selection is underlined until another selection is made.

## Softkeys that Toggle On or Off

Some softkey functions can be toggled on or off, averaging is an example. The current state, ON or OFF, is capitalized in the softkey label.

Example: [AVERAGING ON off] Averaging is turned on.  
[AVERAGING on OFF]. Averaging is turned off.

## Softkeys that Show Status Indications in Brackets

Some softkey labels show the current status of a function in brackets. These include simple toggle functions and status-only indicators. An example of a toggled function is the [PLOT SPEED FAST]/[PLOT SPEED SLOW] softkey. The [IF BW] softkey is an example of a status-only indicator, where the selected value of the IF bandwidth is shown in brackets in the softkey label.

## Main Key Function Groups

The front panel keys that provide access to softkey menus are grouped in the STIMULUS, RESPONSE, and INSTRUMENT STATE function blocks.

**Stimulus Block.** The stimulus block keys and softkey menus control all the functions of the RF source.

**Response Block.** The response block keys and softkey menus control the measurement and display functions specific to the active channel.

**Instrument State Block.** The instrument state keys control channel-independent system functions such as printing and plotting, save/recall, and HP-IB controller mode. In addition major features such as limit testing, test sequencing, and the optional time domain transform (option 010) are accessed under the [SYSTEM] key.

The test sequence function memorizes the steps used to make a measurement, and allows the operator to repeat the measurement by pushing a single key. The test sequencing function has advanced limit test and loop counter decision-making capabilities as well. Test sequencing may be configured to run automatically at power on. Refer to the "Test Sequencing" section for details

## **HP-IB Control**

The functions accessible from the front panel can also be accessed remotely by an external controller using HP-IB. Equivalent HP-IB commands are available for most of the front panel keys and softkey menu selections. In subsequent chapters, each softkey description includes the equivalent HP-IB command in parentheses. Additional information about HP-IB programming is provided in chapter 3.

# FRONT PANEL FEATURES

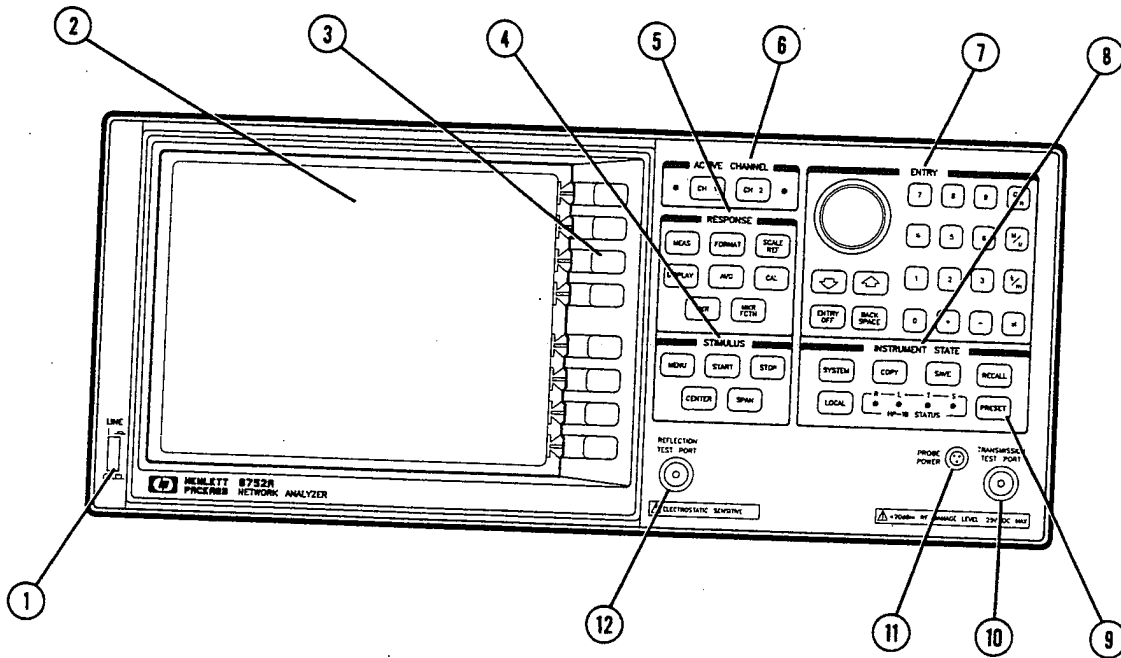

Figure 5-1. The Front Panel

Figure 5-1 illustrates the following features and function blocks of the front panel. These features are described in more detail in this and subsequent chapters. Instructions for removal and cleaning of the glass display filter are provided in the "Preventive Maintenance" section of the *Service Manual*.



1. **LINE switch.** This controls AC power to the analyzer. 1 is on, 0 is off.
2. **Display.** In addition to the measurement traces, the display provides useful messages, softkey labels, marker values and other information. The display is divided into specific information areas, illustrated in Figure 5-2.
3. **Softkeys.** These keys expand the capabilities of the analyzer with additional functions beyond those of the front panel keys. They provide access to menu selections shown on the display.
4. **STIMULUS function block.** The keys in this block control the RF signal from the built-in RF source, as well as other stimulus functions.
5. **RESPONSE function block.** The keys in this block control the measurement and display functions of the active display channel.
6. **ACTIVE CHANNEL function block.** The analyzer has two independent display channels. These keys are used to select the active channel. Any changes to instrument settings affect the active channel.
7. **The ENTRY function block** includes the knob, the step [**▲**][**▼**] keys, and the number pad. These allow you to enter numeric data and control the markers.
8. **INSTRUMENT STATE function block.** These keys control channel-independent system functions such as:
  - Changing the HP-IB addresses used by the analyzer when controlling external devices (printer, disk drive, power meter). This is done through the [**LOCAL**] key.
  - Printing and plotting (under the [**COPY**] key).
  - Save and Recall, under their respective keys.
  - Limit testing (under the [**SYSTEM**] key).
  - Test sequence function (under the [**SYSTEM**] key).
  - Time domain transform (option 010) (under the [**SYSTEM**] key).
  - Also included in this block are the HP-IB STATUS indicators.
9. [**PRESET**] key. This key returns the instrument to a known standard preset state from any step of any manual procedure. A complete listing of the instrument preset condition is provided in Appendix A at the end of this manual.
10. **TRANSMISSION PORT.** Measures the signal that has passed through the device under test.
11. **PROBE POWER connector** (fused inside the instrument) supplies power to an active probe for in-circuit measurements of AC circuits.
12. **REFLECTION PORT.** Measures the reflected signal from the device under test, and provides the RF stimulus for a transmission measurement.

## DISPLAY

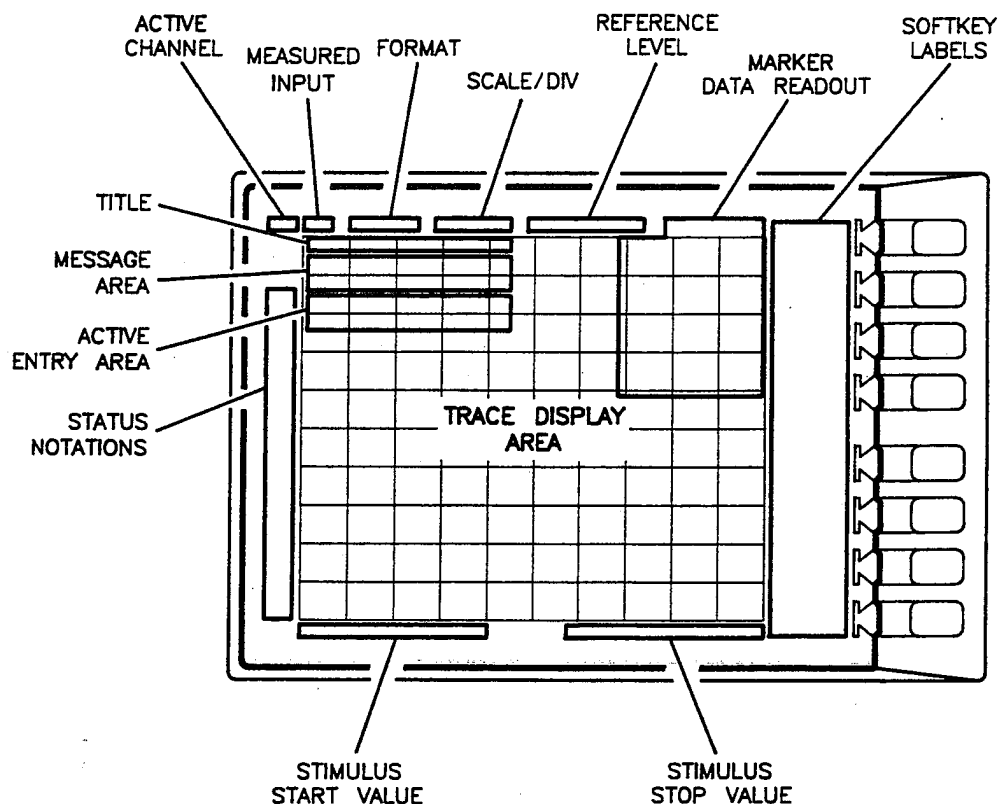

Figure 5-2. Display (Single Channel, Cartesian Format)

Figure 5-2 illustrates the locations of the different display information labels, described below.

In addition to the full-screen display shown above, a split display is available, as described under "[DISPLAY] Key", "Display More Menu" in Chapter 7. In this case, information labels are provided for each half of the display.

Several different display formats for different measurements are illustrated and described in Chapter 7, under "[FORMAT] Key".

**Stimulus Start Value** is the start frequency of the source in frequency domain measurements, the start time in CW mode (0 seconds) or time domain measurements, or the lower power value in power sweep. When the stimulus is in center/span mode, the center stimulus value is shown in this space.

**Stimulus Stop Value** is the stop frequency of the source in frequency domain measurements, the stop time in time domain measurements or CW sweeps, or the upper limit of a power sweep. When the stimulus is in center/span mode, the span is shown in this space. The stimulus values can be blanked, as described under "[DISPLAY] Key", "Display More Menu".

(For CW time and power sweep measurements, the CW frequency is displayed centered between the start and stop times or power values.)

**Status Notations.** This area is used to show the current status of various functions for the active channel. The following notations are used:

- Avg = Sweep-to-sweep averaging is on. The averaging count is shown immediately below (see “[AVG] Key” in Chapter 7).
- Cor = Error correction is on (see “Measurement Calibration”).
- C? = Stimulus parameters have changed, or interpolated error correction is on. (see “Measurement Calibration”, “[CAL] Key”).
- Del = Electrical delay has been added or subtracted (see “[SCALE REF] Key” in Chapter 7).
- Ext = Waiting for an external trigger.
- Gat = Gating is on (time domain option 010 only) (see “Time Domain”).
- Hld = Hold sweep (see “Trigger Menu” in Chapter 8).
- man = Waiting for manual trigger.
- P? = Source power is unlevelled at start or stop of sweep. (Refer to the *Service Manual* for troubleshooting.)
- P↓ = Source power has been automatically set to minimum due to overload (see “Power Menu” in Chapter 8).
- Smo = Trace smoothing is on (see “[AVG] Key” in Chapter 7).
- ↑ = Fast sweep indicator. This symbol is displayed in the status notation block when sweep time is less than 1.0 second. When sweep time is greater than 1.0 second, this symbol moves along the displayed trace.
- \* = Source parameters changed: measured data in doubt until a complete fresh sweep has been taken

**Active Entry Area** displays the active function and its current value.

**Message Area** displays prompts or error messages.

**Title** is a descriptive alpha-numeric string title defined by the user and entered as described under “[DISPLAY] Key” “Title Menu,” in Chapter 7. (In HP-IB, the title block is replaced by HP-IB commands entered from the external controller, if the special debug mode is on. Refer to Chapter 3.)

**Active Channel** is the number of the current active channel (1 or 2), selected with the [ACTIVE CHANNEL] keys. If dual channel is on with an overlaid display, both channel 1 and channel 2 appear in this area.

**Measured Inputs** shows whether transmission (TRN), reflection (RFL), or auxiliary input (AUX) measurement type was selected (using the [MEAS] key). Also indicated in this area is the current display memory status.

**Format** is the display format selected using the [FORMAT] key.

**Scale/Div** is the scale selected using the [SCALE/REF] key, in units appropriate to the current measurement.

**Reference Level** is the value of a reference line in Cartesian formats or the outer circle in polar formats, selected using the [SCALE/REF] key. The reference level is also indicated by a small triangle adjacent to the graticule, at the left for channel 1 and at the right for channel 2.

**Marker Values** are the values of the active marker, in units appropriate to the current measurement. Refer to "Using Markers."

**Marker Stats, Bandwidth** are statistical marker values determined using the menus accessed with the [MKR FCTN] key. Refer to "Using Markers."

**Softkey Labels** shown on the display redefine the function of the softkeys (located to the right of the display).

**NOTE:** The information provided here applies to Cartesian formats. In polar and Smith chart formats labeling may differ.

**REAR PANEL FEATURES AND CONNECTORS**

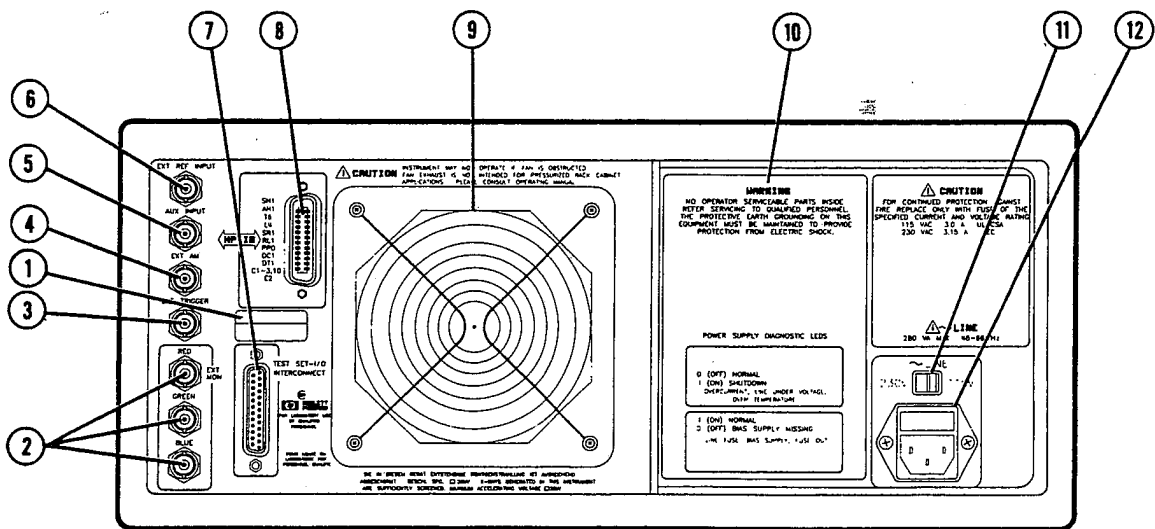

Figure 5-3. Rear Panel

Figure 5-3 illustrates the features and connectors of the rear panel, described below. Requirements for input signals to the rear panel connectors are provided in the "General Characteristics" table in Chapter 2, Specifications.

1. Serial number plate. For information about serial numbers, refer to "Instruments Covered by Manual" in Chapter 1, "General Information."
2. BLUE, GREEN, and RED connectors. Blue, green, and red video output connectors provide analog blue, green and red video signals which can drive an analog multi-sync monitor. The monitor must be compatible with a 25.5 kHz horizontal scan rate and the following video levels: 1Vp-p, 0.7V = white, 0V = black, -0.3V sync, sync on green

Compatible monitors include the HP 35741A color monitor and HP 35731A/B monochrome monitor. These outputs connect to the monitor using standard BNC cables.

**BNC Cables Available:**

- 30 cm (1 foot) HP part number 8120-1838
- 61 cm (2 feet) HP part number 8120-1839
- 122 cm (4 feet) HP part number 8120-1840

3. EXT TRIGGER connector. This is used to connect an external negative-going TTL-compatible signal to trigger a measurement sweep. The trigger can be set to external through a softkey command (see "Trigger Menu" in Chapter 8).
4. EXT AM connector. An AC voltage input here will amplitude modulate the RF output signal.
5. AUX INPUT connector. DC or AC voltages from an external signal source (such as a detector or function generator) can be displayed and measured through this connector. Refer to "[MEAS] key" in Chapter 7. (This connector is also used as an analog output in some service functions described in the *Service Manual*.)
6. EXT REF INPUT connector. Accepts a frequency reference signal which phase locks the analyzer to an external frequency standard. This provides extremely high frequency accuracy.

The external frequency reference feature is automatically enabled when a signal is connected to this input. When the signal is removed, the analyzer automatically switches back to its internal frequency reference.

7. TEST SET INTERCONNECT. This connector is not used in the HP 8752. Do not connect it to any external device. This analyzer cannot be used with external test sets.
8. HP-IB connector. Connects the analyzer to an external computer controller or other instruments in an automated system. Alternatively, the analyzer can control a printer, plotter, disk drive, and power meter through the HP-IB connector. Refer to the installation portion of the *User's Guide* for information and limitations. Information on different controller modes is provided under "[LOCAL] Key" in Chapter 10, or in the *User's Guide*.
9. Fan and Fan Guard. The fan blows air out the back of the analyzer. If you install this instrument in a fan-cooled cabinet, make sure the instrument fan and the cabinet fan blow in the same direction. If they blow in opposite directions, you MUST turn the analyzer's fan around. The *Service Manual* explains how to do this.
10. Safety warnings.
11. Line voltage selector switch.
12. Power cord receptacle, with fuse. Replacement fuse part number is supplied at the end of the *User's Guide*, or at the end of the replaceable parts list in the *Service Manual*.

## Chapter 6. Active Channel Block

---

### ACTIVE CHANNEL KEYS (CHAN1, CHAN2)

The analyzer has two digital channels for independent measurement and display of data. Two different sets of data can be measured simultaneously (for example the reflection and transmission characteristics of a device) or one measurement with two different frequency spans. The data can be displayed separately or simultaneously, as described below.

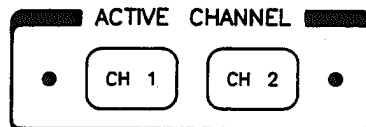

Figure 6-1

The [CH 1] and [CH 2] keys illustrated in Figure 6-1 select which channel is the “active channel”. This is the channel currently controlled by the front panel keys, and its trace and data annotations are shown on the display. All channel-specific functions selected apply to the active channel. The current active channel is indicated by an amber LED adjacent to the corresponding channel key.

The analyzer has dual trace capability, so that both the active and inactive channel traces can be displayed, either overlaid or on separate graticules (split display). When both channel traces are displayed, the annotations of the active channel are brighter. The dual channel and split display features are available in the display menus. Refer to Chapter 7, or the *User's Guide* for illustrations and descriptions of the different display capabilities.

Source values can be coupled or uncoupled between the two channels, independent of the dual channel and split display functions. Refer to “Stimulus Menu” in Chapter 8 for a listing of the source values that are coupled in stimulus coupled mode.

A third coupling capability is coupled markers. Measurement markers can have the same stimulus values for the two channels, or they can be uncoupled for independent control in each channel. Refer to “Using Markers” for more information about markers.

# RESPONSE FUNCTION BLOCK KEYS and MENUS

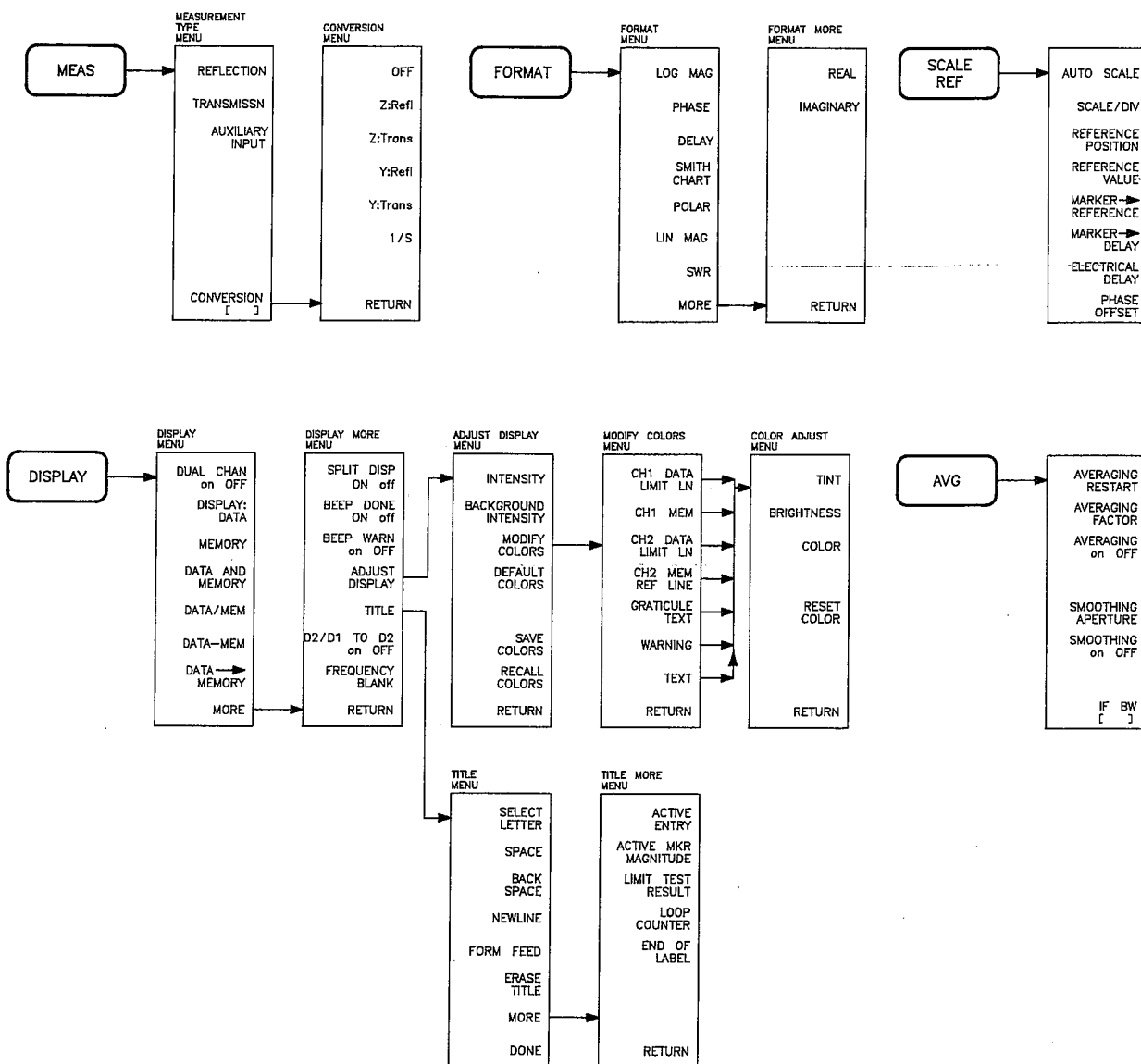

Refer to this foldout menu map as needed when using this tab section.

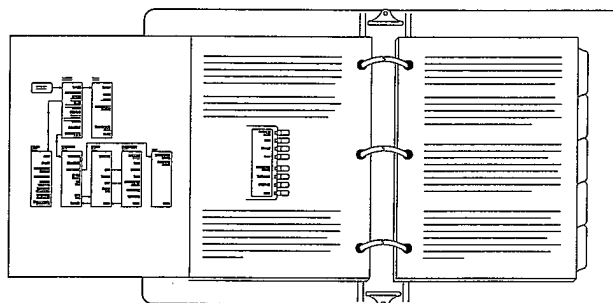

Figure 7-1. Response Keys and Menus

# Chapter 7. Response Function Block

## CHAPTER CONTENTS

7-1	Introduction	7-16	<b>[DISPLAY KEY]</b>
7-3	<b>[MEAS]</b> Key	7-16	Display Menu
7-4	Measurement Type Menu	7-19	Display More Menu
7-5	Conversion Menu	7-20	Adjust Display Menu
7-6	<b>[FORMAT]</b> Key	7-21	Modify Colors Menu
7-6	Format Menu	7-22	Color Adjust Menu
7-11	Format More Menu	7-22	Adjusting Color
7-11	Group delay principles	7-24	Title Menu
7-14	<b>[SCALE REF]</b> Key	7-25	Title More Menu
7-14	Scale Reference Menu	7-25	<b>[AVG]</b> Key
		7-28	Average Menu

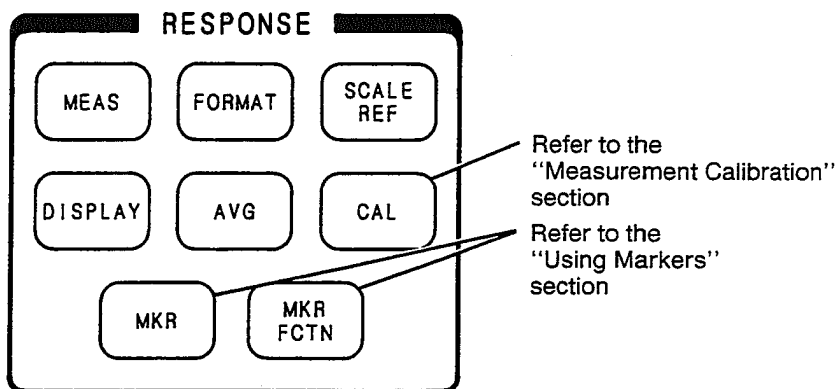

Figure 7-2. Response Function Block

## INTRODUCTION

The keys in the RESPONSE block are used to control the measurement and display functions of the active channel. They provide access to many different softkey menus that offer selections for the parameters to be measured, the display mode and format of the data, the control of the display markers, and a variety of calibration functions.



The HP-IB programming command is shown in parenthesis following the key or softkey.

The current values for the major response functions of the active channel are displayed in specific locations along the top of the display. In addition, certain functions accessed through the keys in this block are annotated in the status notations area at the left side of the display. An illustration showing the locations of these information labels is provided in Chapter 5, together with an explanation.

The RESPONSE block keys and their associated menus are described briefly below, and in more detail in this and the following chapters. General and specific measurements are described in the *User's Guide*.

The **[MEAS]** (MENUMEAS) key provides access to a series of softkey menus for selecting the parameters or inputs to be measured.

The **[FORMAT]** (MENUFORM) key leads to a menu which selects the display format for the data. Various rectangular and polar formats are available for display of magnitude, phase, impedance, group delay, real data, and SWR.

The **[SCALE REF]** (MENUSCAL) key displays a menu which modifies the vertical axis scale and the reference line value, as well as to add electrical delay.

The **[DISPLAY]** (MENU DISP) key leads to a series of menus for instrument and active channel display functions. The first menu defines the displayed active channel trace in terms of the mathematical relationship between data and trace memory. Other functions include dual channel display (overlaid or split), display intensity, color selection, active channel display title, and frequency blanking.

The **[AVG]** (MENUAVG) key is used to access three different noise reduction techniques: sweep-to-sweep averaging, trace smoothing, and variable IF bandwidth.

## [MEAS] KEY

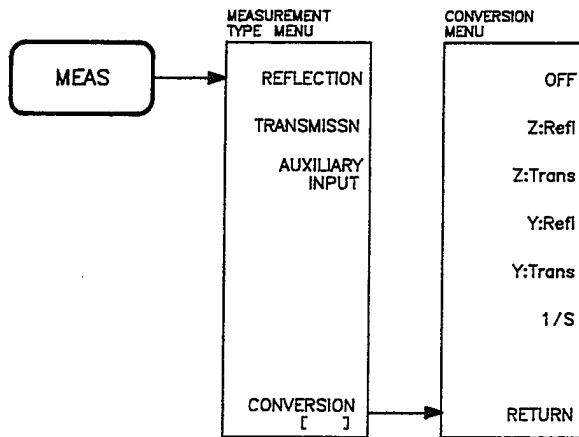

Figure 7-3. Softkey Menus Accessed from the [MEAS] Key

The HP-IB programming command is shown in parenthesis following the key or softkey.

The **[MEAS]** (MENUMEAS) key leads to a series of softkey menus used to determine the parameters or inputs to be measured.

Measured data can be converted to impedance (Z), admittance (Y), or inverse data.

## Measurement Type Menu

The Measurement Type menu is presented when the [MEAS] key is pressed.

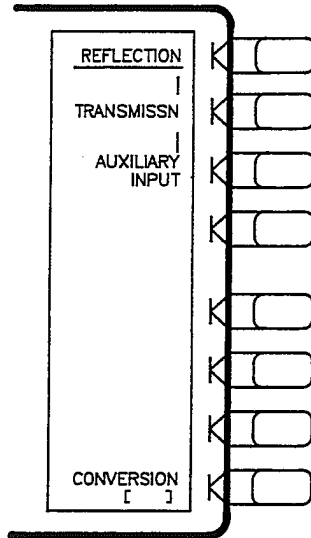

Figure 7-4. Measurement Type Menu

**[REFLECTION]** (RFLP) Measures reflections from the DUT using the Reflection Port. When using a multi-port device, make sure all unused ports are terminated with an appropriate load. The analyzer's Transmission Port is not a recommended termination. Reflection measurements are explained fully in the *User's Guide*, along with examples.

**[TRANSMISSN]** (TRAP) Measures the transmission response of the DUT using the Transmission Port. Transmission measurements are explained fully in the *User's Guide*, along with examples.

**[AUXILIARY INPUT]** (ANAI) Displays a DC or low frequency AC voltage on the vertical axis (using real format). An external signal from a detector or function generator can be measured using the Auxiliary Input connector on the rear panel.

**[CONVERSION]** Formats the data as transmittance, admittance, or inverted data.

When a conversion parameter has been defined, it is shown in brackets under the softkey label. If no conversion has been defined, the softkey label reads **[CONVERSION OFF]**.

## Conversion Menu

This menu converts the measured reflection or transmission data to the equivalent complex impedance (Z) or admittance (Y) values. Two simple one-port conversions are available, depending on the measurement configuration.

A reflection trace measured as reflection can be converted to equivalent parallel impedance or admittance using the model and equations shown in Figure 7-5.

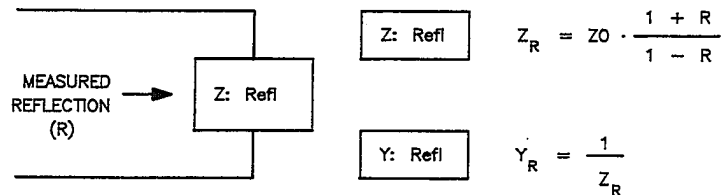

Figure 7-5. Reflection Impedance and Admittance Conversions

In a transmission measurement, the data can be converted to its equivalent series impedance or admittance using the model and equations shown in Figure 7-6.

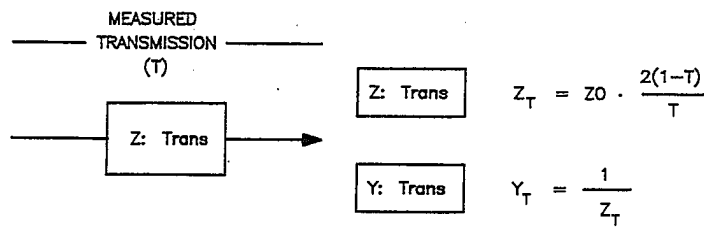

Figure 7-6. Transmission Impedance and Admittance Conversions

Avoid the use of Smith chart, SWR, and delay formats for display of Z and Y conversions, as these formats are not easily interpreted.

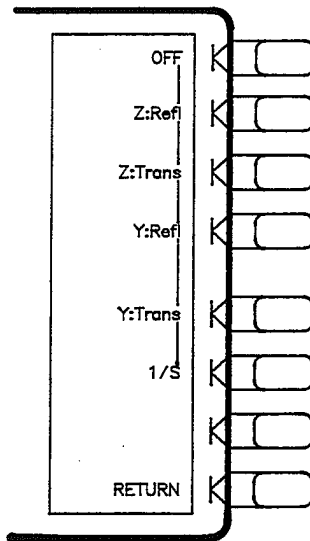

Figure 7-7. Conversion Menu

**[OFF]** (CONVOFF) turns off all parameter conversion operations.

**[Z: Refl]** (CONVZREF) converts reflection data to its equivalent impedance values.

**[Z: Trans]** (CONVZTRA) converts transmission data to its equivalent impedance values.

**[Y: Refl]** (CONVYREF) converts reflection data to its equivalent admittance values.

**[Y: Trans]** (CONVYTRA) converts transmission data to its equivalent admittance values.

**[1/S]** (CONV1DS) expresses the data in inverse values, for use in amplifier and oscillator design.

**[RETURN]** returns to the last menu.

## **[FORMAT] KEY**

### **Format Menu**

The **[FORMAT]** (MENUFORM) key presents a menu used to select the appropriate display format for the measured data. Various rectangular and polar formats are available for display of magnitude, phase, real data, imaginary data, impedance, group delay, and SWR. The units of measurement are changed automatically to correspond with the displayed format. Special marker menus are available for the polar and Smith formats, each providing several different marker types for readout of values (see "Using Markers").

The illustrations below show a reflection measurement of a bandpass filter displayed in each of the available formats.

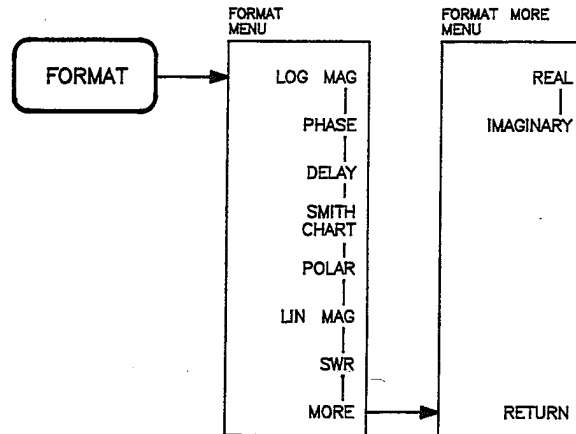

Figure 7-8. Format and Format More Menus

**[LOG MAG]** (LOGM) displays the log magnitude format. This is the standard Cartesian format used to display magnitude-only measurements of insertion loss, return loss, or absolute power in dB versus frequency. Figure 7-9 illustrates the bandpass filter reflection data in a log magnitude format.

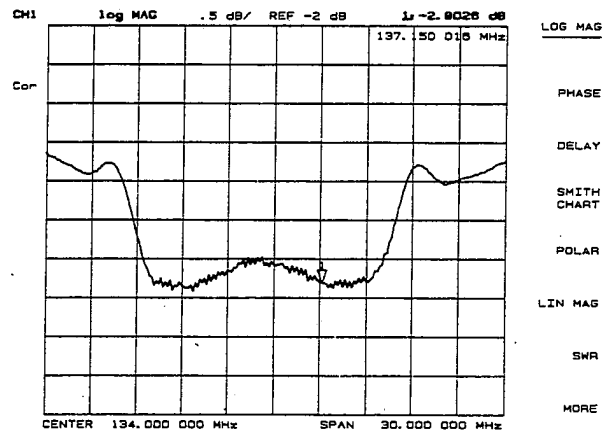

Figure 7-9. Log Magnitude Format

**[PHASE]** (PHAS) displays a Cartesian format of the phase portion of the data, measured in degrees. This format displays the phase shift versus frequency. Figure 7-10 illustrates the phase response of the same filter in a phase-only format. A measurement of phase response is described in the *User's Guide*.

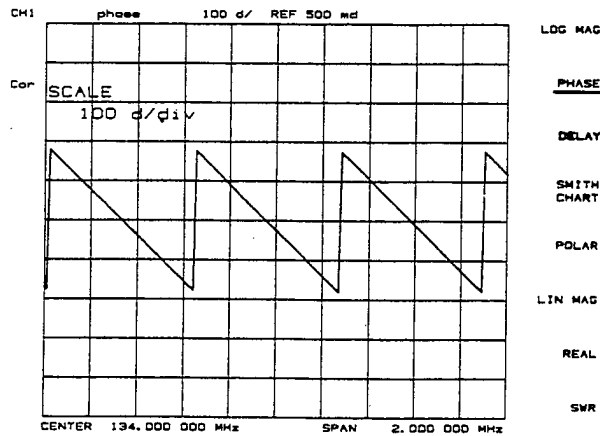

Figure 7-10. Phase Format

**[DELAY]** (DELA) selects the group delay format, with marker values given in seconds. Figure 7-11 shows the bandpass filter response formatted as group delay. Group delay principles are described in the next few pages.

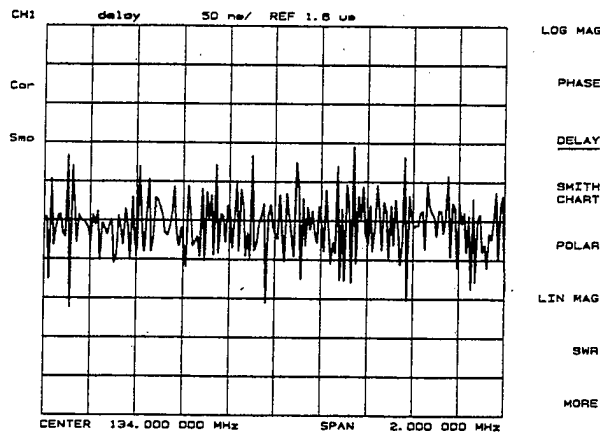

Figure 7-11. Group Delay Format

**[SMITH CHART]** (SMIC) displays a Smith chart format (Figure 7-12). This is used in reflection measurements to provide a readout of the data in terms of impedance. The intersecting dotted lines on the Smith chart represent constant resistance and constant reactance values, normalized to the characteristic impedance,  $Z_0$ , of the system. Reactance values in the upper half of the Smith chart circle are positive (inductive) reactance, and in the lower half of the circle are negative (capacitive) reactance. The default marker readout is in units of resistance and reactance ( $R + jX$ ). Additional marker types are available in the Smith marker menu (refer to "Using Markers").

The Smith chart is most easily understood with a full scale value of 1.0. If the scale per division is less than 0.2, the format switches automatically to polar.

If the characteristic impedance of the system is not 50 ohms (for HP 8752A) or 75 ohms (for HP 8752B), modify the impedance value recognized by the analyzer using the **[SET Z0]** softkey in the calibrate more menu. Refer to "Measurement Calibration."

An inverted Smith chart format for admittance measurements (Figure 7-12) is also available. Access this by selecting **[SMITH CHART]** in the format menu, and pressing **[MKR] [MARKER MODE MENU] [SMITH MKR MENU] [G+jB MKR]**. The Smith chart is reversed and marker values are read out in units of conductance and susceptance ( $G+jB$ ).

Procedures for measuring impedance and admittance are provided in the *User's Guide*.

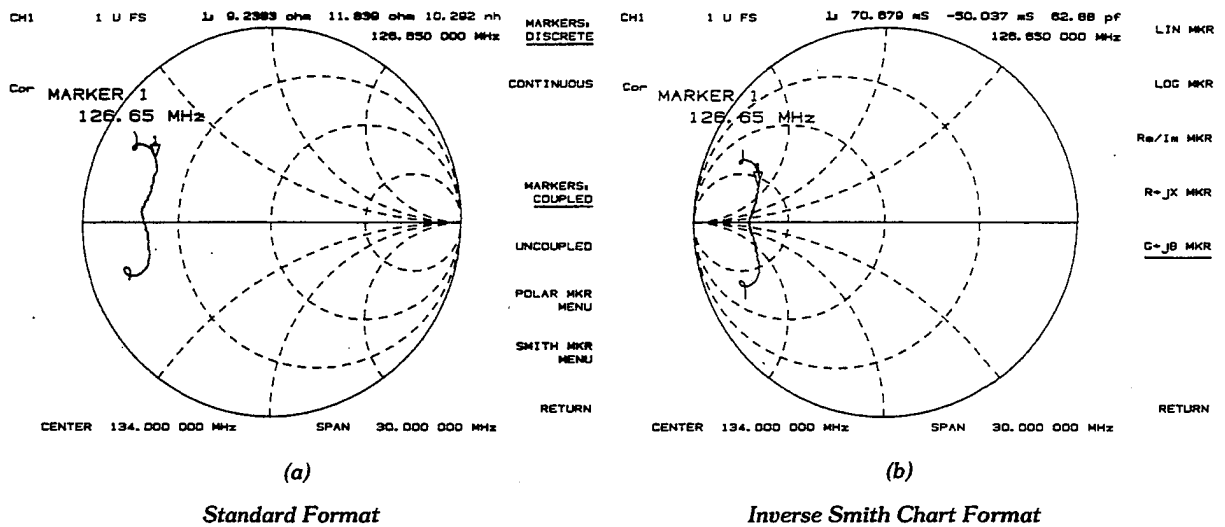

Figure 7-12. Standard and Inverse Smith Chart Formats

**[POLAR]** (POLA) displays a polar format (Figure 7-13). Each point on the polar format corresponds to a particular value of both magnitude and phase. Quantities are read vectorally: the magnitude at any point is determined by its displacement from the center (which has zero value), and the phase by the angle counterclockwise from the positive x-axis. Magnitude is scaled in a linear fashion, with the value of the outer circle usually set to a ratio value of 1. Since there is no frequency axis, frequency information is read from the markers.

The default marker readout for the polar format is in linear magnitude and phase. A log magnitude marker and a real/imaginary marker are available in the polar marker menu (refer to "Using Markers").

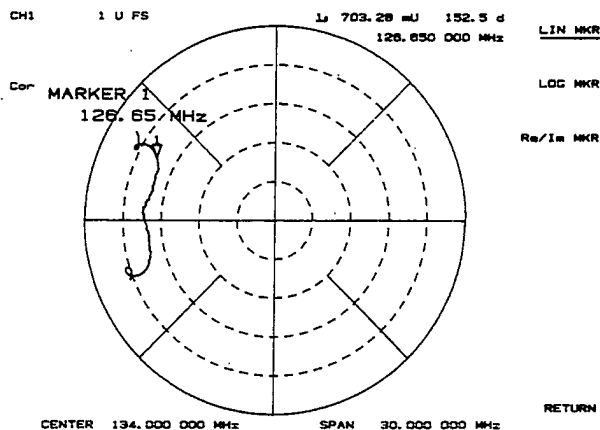

Figure 7-13. Polar Format



**[LIN MAG]** (LINM) displays the linear magnitude format (Figure 7-14). This is a Cartesian format used for unitless measurements such as reflection coefficient magnitude  $\rho$  or transmission coefficient magnitude  $\tau$ , and for linear measurement units. It is used for display of conversion parameters and time domain transform data.

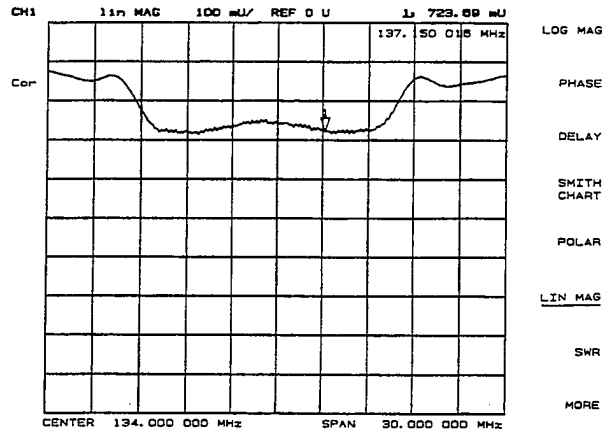

Figure 7-14. Linear Magnitude Format

**[SWR]** (SWR) reformats a reflection measurement into its equivalent SWR (standing wave ratio) value (Figure 7-15). SWR is equivalent to  $(1 + \rho)/(1 - \rho)$ , where  $\rho$  is the reflection coefficient. Note that the results are valid only for reflection measurements.

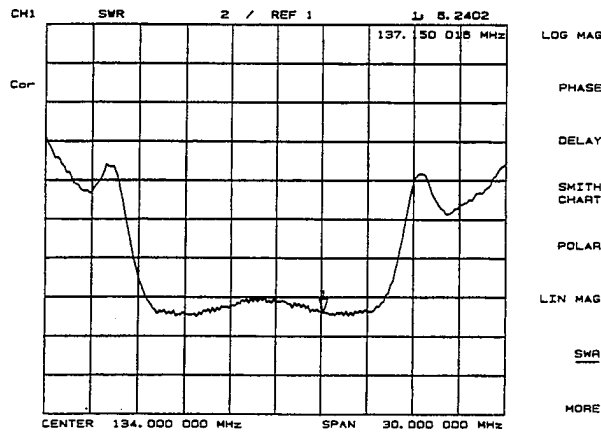

Figure 7-15. Typical SWR Display

**[MORE]** goes to the format more menu described on the next page.

## Format More Menu

This menu provides two additional formatting selections.

**[REAL]** (REAL) displays only the real (resistive) portion of the measured data on a Cartesian format (Figure 7-16). This is similar to the linear magnitude format, but can show both positive and negative values. It is primarily used for analyzing responses in the time domain, and also to display an auxiliary input voltage signal for service purposes.

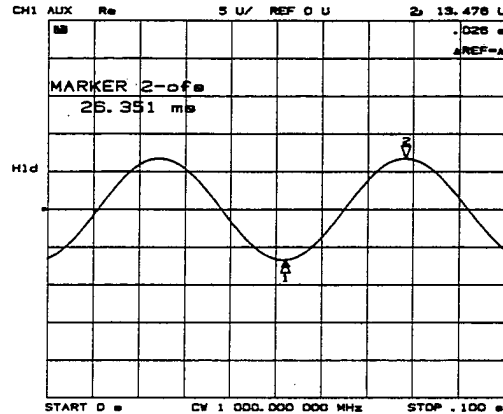

Figure 7-16. Real Format

**[IMAGINARY]** (IMAG) displays only the imaginary (reactive) portion of the measured data on a Cartesian format. This format is similar to the real format except that reactance data is displayed on the trace instead of resistive data.

**[RETURN]** goes back to the format menu.

## GROUP DELAY PRINCIPLES

For many networks, the amount of insertion phase is not as important as the linearity of the phase shift over a range of frequencies. The analyzer can measure this linearity and express it in two different ways: directly, as deviation from linear phase, or as group delay, a derived value. Refer to **[SCALE REF]** key description in this chapter for information on deviation from linear phase.

Group delay is the measurement of signal transmission time through a test device. It is defined as the derivative of the phase characteristic with respect to frequency. Since the derivative is basically the instantaneous slope (or rate of change of phase with frequency), a perfectly linear phase shift results in a constant slope, and therefore a constant group delay (Figure 7-17).

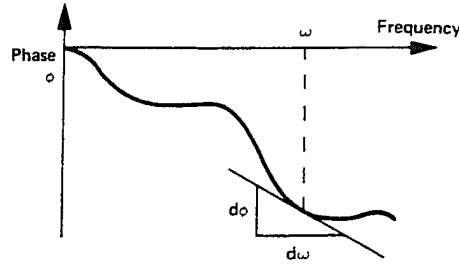
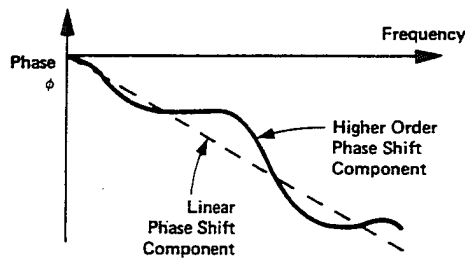

Figure 7-17. Constant Group Delay

Note, however, that the phase characteristic typically consists of both linear and higher order (deviations from linear) components. The linear component can be attributed to the electrical length of the test device, and represents the average signal transit time. The higher order components are interpreted as variations in transit time for different frequencies, and represent a source of signal distortion (Figure 7-18).



$$\text{Group Delay} = \tau_g = \frac{-d\phi}{d\omega} \quad \begin{array}{l} \phi \text{ in Radians} \\ \omega \text{ in Radians} \end{array}$$

$$= \frac{-1}{360^\circ} \cdot \frac{d\phi}{df} \quad \begin{array}{l} \phi \text{ in Degrees} \\ f \text{ in Hz } (\omega = 2\pi f) \end{array}$$

Figure 7-18. Higher Order Phase Shift

The analyzer computes group delay from the phase slope. Phase data is used to find the phase change,  $\Delta\phi$ , over a specified frequency aperture,  $\Delta f$ , to obtain an approximation for the rate of change of phase with frequency (Figure 7-19). This value,  $\tau_g$ , represents the group delay in seconds assuming linear phase change over  $\Delta f$ . It is important that  $\Delta\phi$  be  $\leq 180^\circ$ , or errors will result in the group delay data. These errors can be significant for long delay devices. You can verify that  $\Delta\phi$  is  $\leq 180^\circ$  by increasing the number of points or narrowing the frequency span (or both) until the group delay data no longer changes.

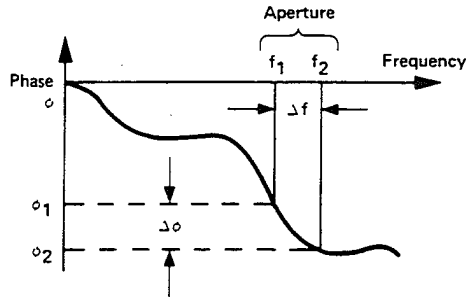

Figure 7-19. Rate of Phase Change Versus Frequency

When deviations from linear phase are present, changing the frequency step can result in different values for group delay. Note that in this case the computed slope varies as the aperture  $\Delta f$  is increased (Figure 7-20). A wider aperture results in loss of the fine grain variations in group delay. This loss of detail is the reason that in any comparison of group delay data it is important to know the aperture used to make the measurement.

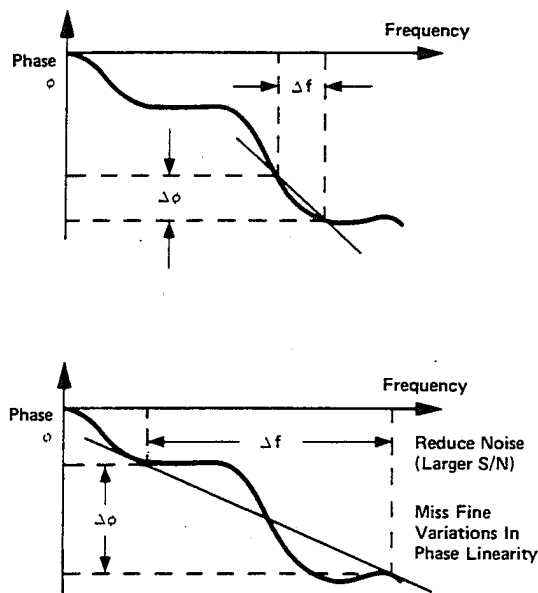

Figure 7-20. Variations in Frequency Aperture

In determining the group delay aperture, there is a tradeoff between resolution of fine detail and the effects of noise. Noise can be reduced by increasing the aperture, but this will tend to smooth out the fine detail. More detail will become visible as the aperture is decreased, but the noise will also increase, possibly to the point of obscuring the detail. A good practice is to use a smaller aperture to assure that small variations are not missed, then increase the aperture to smooth the trace.

The default group delay aperture is the frequency span divided by the number of points across the display. To set the aperture to a different value, turn on smoothing in the average menu, and vary the smoothing aperture (see [AVG] Key). The aperture can be varied up to 20% of the span swept.

Group delay measurements can be made on linear frequency, log frequency, or list frequency sweep types (not in CW or power sweep). Group delay aperture varies depending on the frequency spacing and point density, therefore the aperture is not constant in log and list frequency sweep modes. In list frequency mode, extra frequency points can be defined to ensure the desired aperture.

To obtain a readout of aperture values at different points on the trace, turn on a marker. Then press **[AVG] [SMOOTHING APERTURE]**. Smoothing aperture becomes the active function, and as the aperture is varied its value in Hz is displayed below the active entry area.

A group delay measurement procedure is provided in the *User's Guide*.

## [SCALE REF] KEY

The HP-IB programming command is shown in parenthesis following the key or softkey.

### Scale Reference Menu

The **[SCALE REF] (MENUSCAL)** key makes scale per division the active function. A menu is displayed that is used to modify the vertical axis scale and the reference line value and position. In addition this menu provides electrical delay offset capabilities for adding or subtracting linear phase to maintain phase linearity.

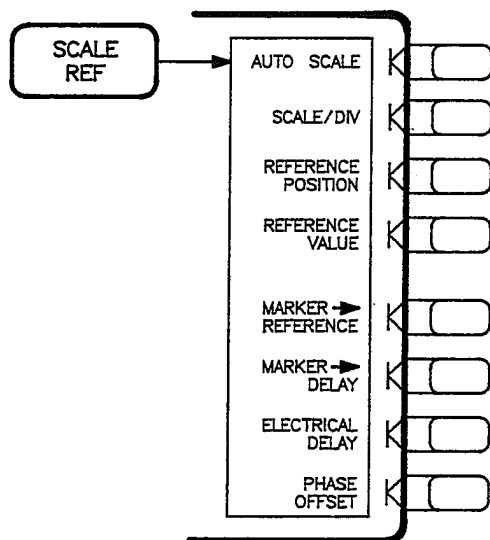

Figure 7-21. Scale Reference Menu

**[AUTO SCALE] (AUTO)** brings the trace data in view on the display with one keystroke. Stimulus values are not affected, only scale and reference values. The analyzer determines the smallest possible scale factor that will put all displayed data onto 80% of the vertical graticule. The reference value is chosen to put the trace in the center of the display.

**[SCALE/DIV] (SCAL)** changes the response value scale per division of the displayed trace. In polar and Smith chart formats, this refers to the full scale value at the outer circumference, and is identical to reference value.

**[REFERENCE POSITION]** (REFP) sets the position of the reference line on the graticule of a Cartesian display, with 0 the bottom line of the graticule and 10 the top line. It has no effect on a polar or Smith display. The reference position is indicated with a small triangle just outside the graticule, on the left side for channel 1 and the right side for channel 2.

**[REFERENCE VALUE]** (REFV) changes the value of the reference line, moving the measurement trace correspondingly. In polar and Smith chart formats, the reference value is the same as the scale, and is the value of the outer circle.

**[MARKER → REFERENCE]** (MARKREF) makes the reference value equal to the active marker's absolute value (regardless of the delta marker value). The marker is effectively moved to the reference line position. This softkey also appears in the marker function menu accessed from the **[MKR FCTN]** key. In polar and Smith chart formats this function makes the full scale value at the outer circle equal to the active marker response value.

**[MARKER → DELAY]** (MARKDELA) adjusts the electrical delay to balance the phase of the DUT. This is performed automatically, regardless of the format and the measurement being made. Enough line length is added to or subtracted from the receiver input to compensate for the phase slope at the active marker position. This effectively flattens the phase trace around the active marker, and can be used to measure electrical length or deviation from linear phase. Additional electrical delay adjustments are required on DUTs without constant group delay over the measured frequency span. Since this feature adds phase to a variation in phase versus frequency, it is applicable only for ratioed inputs.

**[ELECTRICAL DELAY]** (ELED) adjusts the electrical delay to balance the phase of the DUT. It simulates a variable length lossless transmission line, which can be added to or removed from a receiver input to compensate for interconnecting cables, etc. This function is similar to the mechanical or analog "line stretchers" of other network analyzers. Delay is annotated in units of time with secondary labeling in distance for the current velocity factor.

With this feature, and with **[MARKER → DELAY]**, an equivalent length of air is added or subtracted according to the following formula:

$$\text{Length (meters)} = \frac{\phi}{F(\text{MHz}) \times 1.20083}$$

Once the linear portion of the DUT's phase has been removed, the equivalent length of air can be read out in the active marker area. If the average relative permittivity ( $\epsilon_r$ ) of the DUT is known over the frequency span, the length calculation can be adjusted to indicate the actual length of the DUT more closely. This can be done by entering the relative velocity factor for the DUT using the Calibrate More Menu (under the **[CAL]** Key). The relative velocity factor for a given dielectric can be calculated by:

$$\text{Velocity factor} = 1/\sqrt{\epsilon_r}$$

assuming a relative permeability of 1.

A procedure for measuring electrical length or deviation from linear phase using the **[ELECTRICAL DELAY]** or **[MARKER → DELAY]** features is provided in the *User's Guide*.

**[PHASE OFFSET]** (PHAO) adds or subtracts a phase offset that is constant with frequency (rather than linear). This is independent of **[MARKER → DELAY]** and **[ELECTRICAL DELAY]**.

## [DISPLAY] KEY

The HP-IB programming command is shown in parentheses following the key or softkey.

The [DISPLAY] (MENUDISP) key provides access to the memory math functions, and other display functions including dual channel display, active channel display title, frequency blanking, display intensity, background intensity, and color selection.

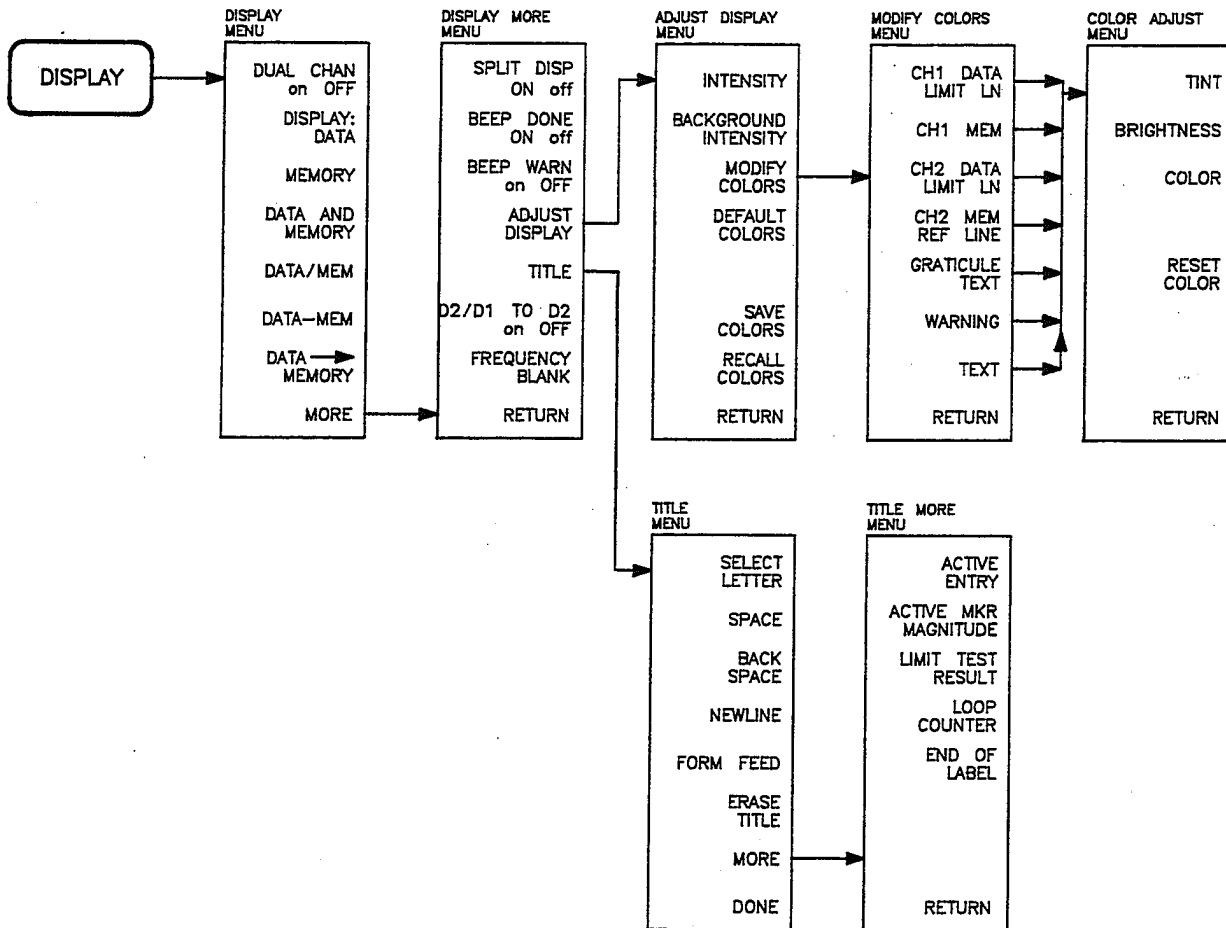

Figure 7-22. Softkey Menus Accessed from the [DISPLAY] Key

## Display Menu

This menu provides trace math capabilities for manipulating data, as well as the capability of displaying both channels simultaneously, either overlaid or split.

The analyzer has two available memory traces, one per channel. Memory traces are totally channel dependent: channel 1 cannot access the channel 2 memory trace or vice versa. Memory traces can be saved with instrument states: one memory trace can be saved per channel per saved instrument state. Five save/recall registers are available for each channel, so the total number of memory traces that can be present is 10. The memory data is stored as full precision, complex data.

Two trace math operations are available, data/memory and data–memory. (Note that normalization is data/memory.) Trace math is done immediately after error correction. This means that any data processing done after error correction, including parameter conversion, time domain transformation, scaling, etc., can be performed on the memory trace. (Refer to *Data Processing* in Chapter 4.) Trace math can also be used as a simple means of error correction, although that is not its main purpose.

All data processing operations that occur after trace math, except smoothing and gating, are identical for the data trace and the memory trace. If smoothing or gating is on when a memory trace is saved, this state is maintained regardless of the data trace smoothing or gating status. If a memory trace is saved with gating or smoothing on, these features can be turned on or off in the memory-only display mode.

The actual memory for storing a memory trace is allocated only as needed. The memory trace is cleared on instrument preset, power on, or instrument state recall.

If sweep mode or sweep range is different between the data and memory traces, trace math is allowed, and no warning message is displayed. If the number of points in the two traces is different, the memory trace is not displayed nor rescaled. However, if the number of points for the data trace is changed back to the number of points in the memory, the memory trace can then be displayed.

If trace math or display memory is requested and no memory trace exists, the message “CAUTION: NO VALID MEMORY TRACE” is displayed.

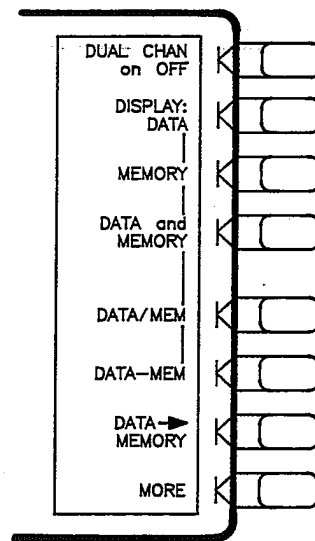
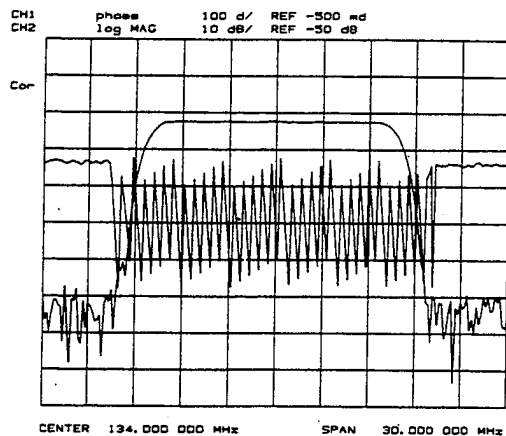

Figure 7-23. Display Menu

**[DUAL CHAN on OFF]** (DUACON, DUACOFF) toggles between display of both measurement channels or the active channel only. This is used in conjunction with **[SPLIT DISP ON off]** in the display more menu to display both channels. With **[SPLIT DISP OFF]** the two traces are overlaid on a single graticule (Figure 7-24a); with **[SPLIT DISP ON]** the measurement data is displayed on two half-screen graticules one above the other (Figure 7-24b). Current parameters for the two displays are annotated separately.

The stimulus functions of the two channels can also be controlled independently using **[COUPLED CH ON]** in the stimulus menu. In addition, the markers can be controlled independently for each channel using **[MARKERS: UNCOUPLED]** in the marker mode menu.





(a) Overlaid Traces

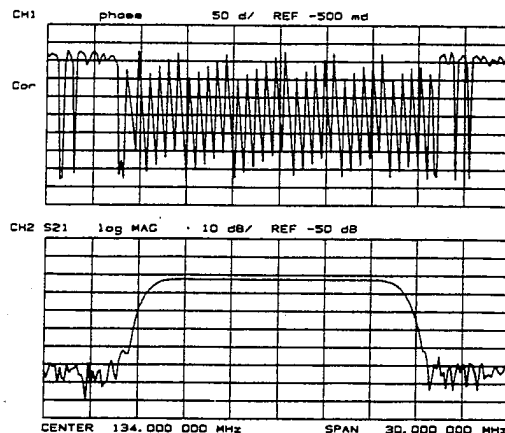

(b) Split Display

Figure 7-24. Dual Channel Displays

**[DISPLAY: DATA]** (DISPDATA) displays the current measurement data for the active channel.

**[MEMORY]** (DISPMEMO) displays the trace memory for the active channel. This is the only memory display mode where the smoothing and gating of the memory trace can be changed. If no data has been stored in memory for this channel, a message is displayed.

**[DATA and MEMORY]** (DISPDATM) displays both the current data and memory traces.

**[DATA/MEM]** (DISPDDM) divides the data by the memory, normalizing the data to the memory, and displays the result. This is useful for ratio comparison of two traces, for instance in measurements of gain or attenuation.

**[DATA — MEM]** (DISPDMM) subtracts the memory from the data. The vector subtraction is performed on the complex data. This is appropriate for storing a measured vector error, for example directivity, and later subtracting it from the device measurement.

**[DATA → MEMORY]** (DATI) stores the current active measurement data in the memory of the active channel. It then becomes the memory trace, for use in subsequent math manipulations or display. If a measurement parameter has just been changed (the \* status notation is displayed at the left of the display), the displayed sweep does not yet match the new settings. In this case, the data is not stored in memory until a new sweep has been executed. The gating and smoothing status of the trace are stored with the measurement data.

**[MORE]** leads to the display more menu.

## Display More Menu

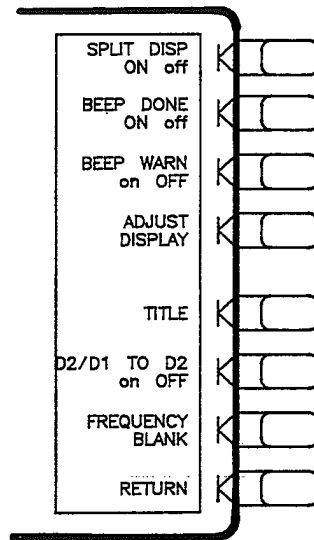

Figure 7-25. Display More Menu

**[SPLIT DISP on OFF]** (SPLDON, SPLDOFF) toggles between a full-screen single graticule display of one or both channels, and a split display with two half-screen graticules one above the other. Both displays are illustrated in Figure 7-24. The split display can be used in conjunction with **[DUAL CHAN ON]** in the display menu to show the measured data of each channel simultaneously on separate graticules. In addition, the stimulus functions of the two channels can be controlled independently using **[COUPLED CH ON]** in the stimulus menu. The markers can also be controlled independently for each channel using **[MARKERS: UNCOUPLED]** in the marker mode menu.

**[BEEP DONE ON off]** (BEEPDONEON, BEEPDONEOFF) toggles an annunciator which sounds to indicate completion of certain operations such as calibration or instrument state save.

**[BEEP WARN on OFF]** (BEEPWARNON, BEEPWARNOFF) toggles the warning annunciator. When the annunciator is on it sounds a warning when any cautionary message is displayed.

**[ADJUST DISPLAY]** presents a menu for adjusting display intensity, colors, and accessing save and recall functions for modified display color sets.

**[TITLE]** (TITL) presents the title menu in the softkey labels area and the character set in the active entry area. These are used to label the active channel display. A title more menu allows up to four values to be included in the printed title; active entry, active marker amplitude, limit test results, and loop counter value.

**[FREQUENCY BLANK]** (FREO) blanks the displayed frequency notation for security purposes. Frequency labels cannot be restored except by instrument preset or turning the power off and then on.

**[D2/D1 to D2]** (D1DIVD2) this math function ratios channels 1 and 2, and puts the results in the channel 2 data array. Both channels must be on and have the same number of points.

**[RETURN]** goes back to the display menu.

## Adjust Display Menu

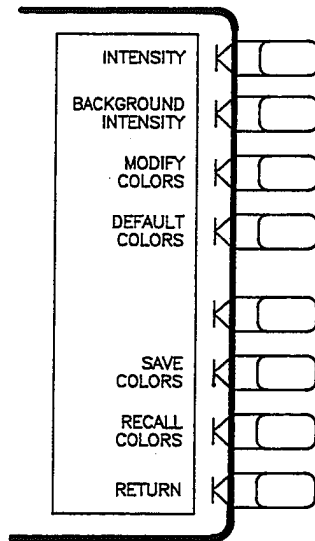

Figure 7-26. Adjust Display Menu

**[INTENSITY]** (INTE) sets the display intensity as a percent of the brightest setting. The factory-set default value is stored in non-volatile memory.

**[BACKGROUND INTENSITY]** (BACI) sets the background intensity of the display as a percent of white. The factory-set default value is stored in non-volatile memory.

**[MODIFY COLORS]** presents a menu for color modification of display elements. Refer to "Adjusting Color," later in this chapter.

**[DEFAULT COLORS]** (DEFC) returns all the color settings back to the factory-set default values.

**[SAVE COLORS]** (SVCO) saves the modified version of the color set.

**[RECALL COLORS]** (RECO) recalls the previously saved modified version of the color set. This key appears only when a color set has been saved.

**[RETURN]** goes back to the display more menu.

## Modify Colors Menu

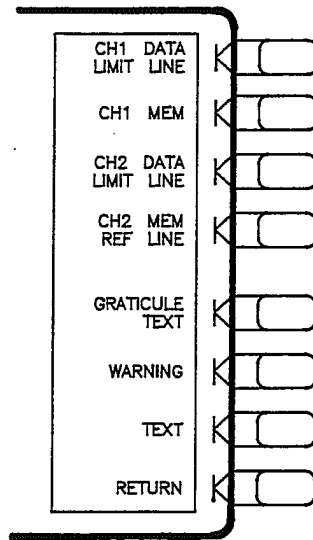

Figure 7-27. Modify Colors Menu

**[CH1 DATA/LIMIT LN]** (COLOCH1D) selects channel 1 data trace and limit line for color modification.

**[CH1 MEM]** (COLOCH1M) selects channel 1 memory trace for color modification.

**[CH2 DATA/LIMIT LN]** (COLOCH2D) selects channel 2 data trace and limit line for color modification.

**[CH2 MEM/REF LINE]** (COLOCH2M) selects channel 2 memory and the reference line for color modification.

**[GRATICULE/TEXT]** (COLOGRAT) selects the graticule and a portion of softkey text (where there is a choice of a feature being on or off) for color modification. For example: [FREQUENCY BLANK on OFF].

**[WARNING]** (COLOWARN) selects the warning annotation for color modification.

**[TEXT]** (COLOTEXT) selects all the non-data text for color modification. For example: operating parameters.

**[RETURN]** goes back to the adjust display menu.

## Color Adjust Menu

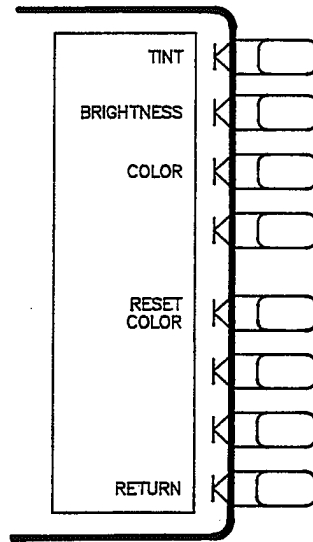

Figure 7-28. Color Adjust Menu

**[TINT]** (TINT) adjusts the continuum of hues on the color wheel of the chosen attribute. See “Adjusting Color” for an explanation of using this softkey for color modification of display attributes.

**[BRIGHTNESS]** (CBRI) adjusts the brightness of the color being modified. See “Adjusting Color” for an explanation of using this softkey for color modification of display attributes.

**[COLOR]** (COLOR) adjusts the degree of whiteness of the color being modified. See “Adjusting Color” for an explanation of using this softkey for color modification of display attributes.

**[RESET COLOR]** (RSCO) resets the color being modified to the default color.

**[RETURN]** goes back to the modify colors menu.

### Adjusting Color

This procedure explains how to adjust the colors on your analyzer display. The default colors in this instrument have been scientifically chosen to maximize your ability to discern the difference between the colors, and to comfortably and effectively view the colors. These colors are recommended for normal use because they will provide a suitable contrast that is easy to view for long periods of time.

You may want to change the default colors to suit environmental needs, individual preferences, or to accommodate color deficient vision. You can use any of the available colors for any of the seven display elements listed by the softkey names below:

- **[CH1 DATA/LIMIT LN]**
- **[CH1 MEM]**
- **[CH2 DATA/LIMIT LN]**
- **[CH2 MEM/REF LINE]**
- **[GRATICULE/TEXT]**
- **[WARNING]**
- **[TEXT]**

To change the color of a display element, press the softkey for that element (such as [CH1 DATA]). Then press [TINT] and turn the front panel knob until the desired color appears. The step keys or numeric keypad can also be used.

Color is comprised of three parameters:

Tint - The continuum of hues on the color wheel, ranging from red, through green and blue, and back to red.

Brightness - A measure of the brightness of the color.

Color - The degree of whiteness of the color. A scale from white to pure color.

The most frequently occurring color deficiency is the inability to distinguish red, yellow, and green from one another. Confusion between these colors can usually be eliminated by increasing the brightness between the colors. To do this, press the [BRIGHTNESS] softkey and turn the front panel knob. If additional adjustment is needed, vary the degree of whiteness of the color. To do this, press the [COLOR] softkey and turn the front panel knob.

**NOTE:** Color changes and adjustments remain in effect until changed again in these menus or the analyzer is turned off. Preset does not affect the selected colors.

### **Setting Default Colors**

To set all the display elements to the factory-defined default colors, press:

[DISPLAY] [MORE] [ADJUST DISPLAY] [DEFAULT COLORS]

### **Saving Modified Colors**

To save the modified color set, press:

[DISPLAY] [MORE] [ADJUST DISPLAY] [SAVE COLORS]

Modified colors are not part of a saved instrument state and are lost unless saved using these softkeys.

### **Recalling Modified Colors**

To recall the previously saved color set, press:

[DISPLAY] [MORE] [ADJUST DISPLAY] [RECALL COLORS]

## Title Menu

Use this menu to specify a title for the active channel. The title identifies the display regardless of stimulus or response changes, and is printed or plotted with the data. If the display is saved in a register with the instrument state, the title is saved with it.

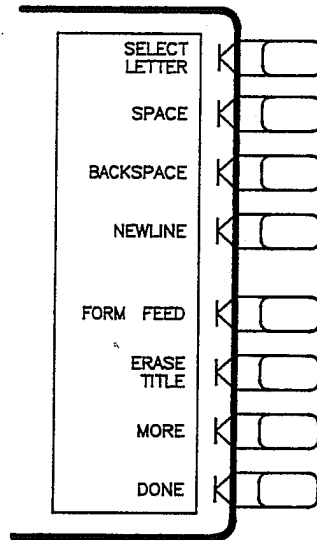

Figure 7-29. Title Menu

**[SELECT LETTER]**. The active entry area displays the letters of the alphabet, digits 0 through 9, and mathematical symbols. To define a title, press **[ERASE TITLE]** and rotate the knob until the arrow  $\uparrow$  points to the first desired letter. Press **[SELECT LETTER]**. Keep selecting letters until the complete title is defined. As each character is selected, it is appended to the title at the top of the graticule. A title can only contain 50 characters.

**[SPACE]** inserts a space in the title.

**[BACK SPACE]** deletes the last character entered.

**[NEWLINE]** sends a new line command to the printer.

**[FORM FEED]** advances the printer paper to the next page.

**[ERASE TITLE]** deletes the entire title.

**[MORE]** leads to the title more menu.

**[DONE]** terminates the title entry, and returns to the display more menu.

## Title More Menu

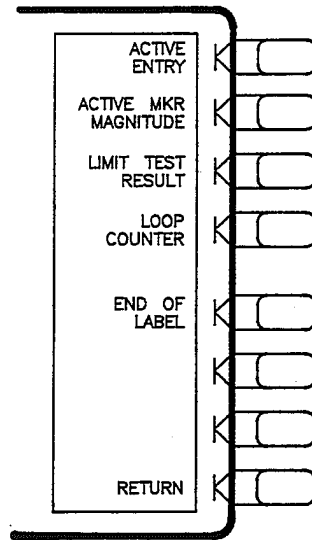

Figure 7-30. Title More Menu

The following softkeys cause the named data to be printed out with the title. This is especially useful when used with the test sequence function.

**[ACTIVE ENTRY]** prints the name of the active entry.

**[ACTIVE MRK AMPLITUDE]** prints the active marker amplitude.

**[LIMIT TEST RESULT]** prints the result of a limit test.

**[LOOP COUNTER]** prints the current value of the loop counter. Refer to "Test Sequencing".

**[END OF LABEL]** terminates the HP-GL "LB" command. Refer to "Test Sequencing".

**[RETURN]** returns to the previous menu.

## [AVG] KEY

The **[AVG]** (MENUAVG) key is used to access three different noise reduction techniques: sweep-to-sweep averaging, display smoothing, and variable IF bandwidth. Any or all of these can be used simultaneously. Averaging and smoothing can be set independently for each channel, and the IF bandwidth can be set independently if the stimulus is uncoupled (**[COUPLED CH OFF]**).

**Averaging** computes each data point based on an exponential average of consecutive sweeps weighted by a user-specified averaging factor. Each new sweep is averaged into the trace until the total number of sweeps is equal to the averaging factor. Each point on the trace is the vector sum of the current trace data and the data from the previous sweeps. A high averaging factor gives the best signal-to-noise ratio, but slows the trace update time. Doubling the averaging factor reduces the noise by 3 dB. Figure 7-31 illustrates the effect of averaging on a log magnitude format trace.



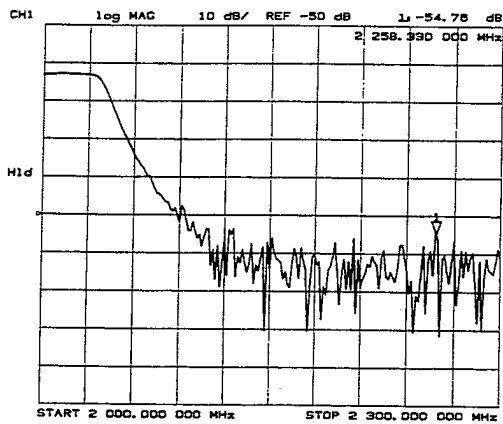

Display with averaging off.

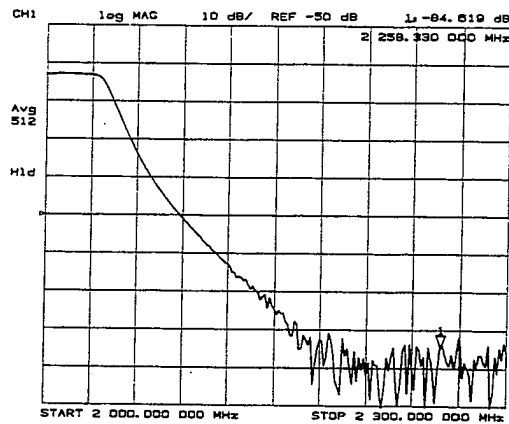

Display with an averaging factor of 512.

Figure 7-31. Effect of Averaging on a Trace

**Smoothing** (similar to video filtering) averages the formatted active channel data over a portion of the displayed trace. Smoothing computes each displayed data point based on one sweep only, using a moving average of several adjacent data points for the current sweep. The smoothing aperture is a percent of the stimulus span swept, up to a maximum of 20%.

Rather than lowering the noise floor, smoothing finds the mid-value of the data. Use it to reduce relatively small peak-to-peak noise values on broadband measured data. Use a sufficiently high number of display points to avoid misleading results. Do not use smoothing for measurements of high resonance devices or other devices with wide variations in trace, as it will introduce errors into the measurement.

Smoothing is used with Cartesian and polar display formats. It is also the primary way to control the group delay aperture, given a fixed frequency span (refer to *Group Delay Principles* earlier in this chapter). In polar display format, large phase shifts over the smoothing aperture will cause shifts in amplitude, since a vector average is being computed. Figure 7-32 illustrates the effect of smoothing on a log magnitude format trace.

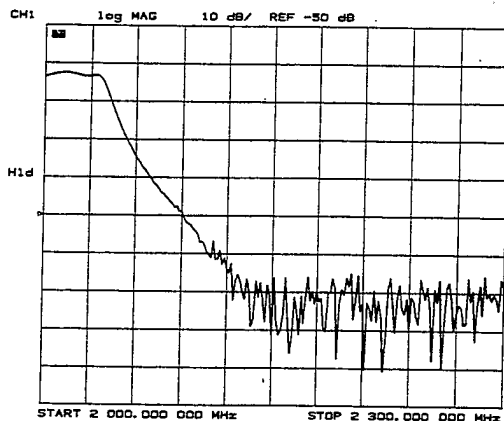

Smoothing off.

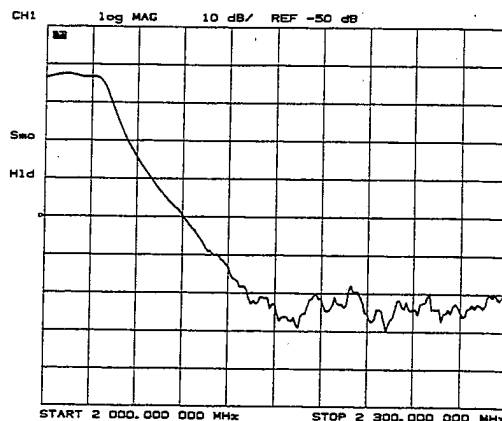

Smoothing on.

Figure 7-32. Effect of Smoothing on a Trace

**IF Bandwidth Reduction** lowers the noise floor by digitally reducing the receiver input bandwidth. It has an advantage over averaging in reliably filtering out unwanted responses such as spurs, odd harmonics, higher frequency spectral noise, and line-related noise. Sweep-to-sweep averaging, however, is better at filtering out very low frequency noise. A tenfold reduction in IF bandwidth (from 3000 Hz to 300 Hz, for example) lowers the measurement noise floor by about 10 dB. Bandwidths less than 300 Hz provide better harmonic rejection than higher bandwidths.

Another difference between sweep-to-sweep averaging and variable IF bandwidth is the sweep time. Averaging displays the first complete trace faster but takes several sweeps to reach a fully averaged trace. IF bandwidth reduction lowers the noise floor in one sweep, but the sweep time may be slower. Figure 7-32A illustrates the difference in noise floor between a trace measured with a 3000 Hz IF bandwidth and with a 10 Hz IF bandwidth.

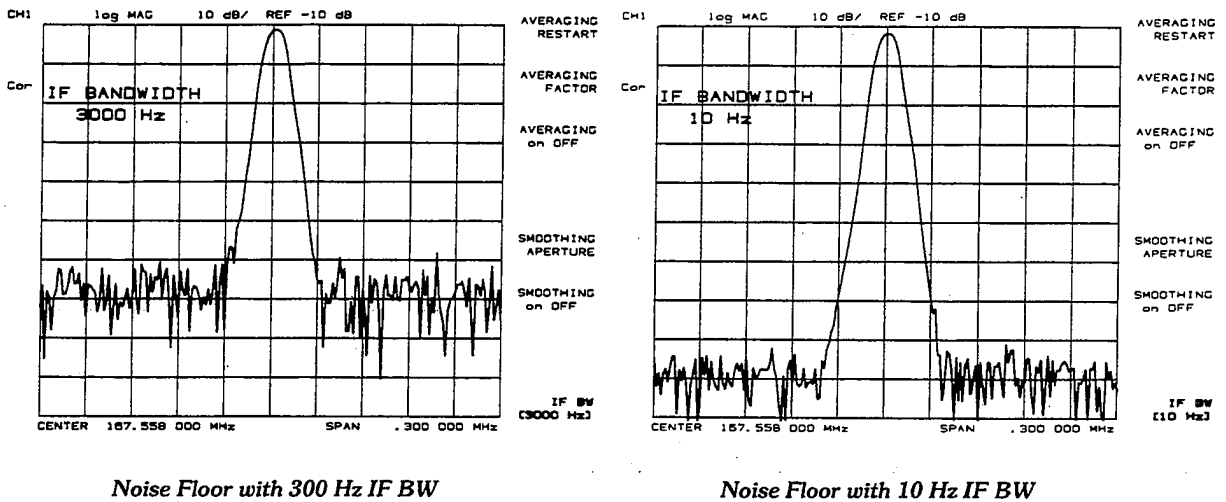

Figure 7-32A. IF Bandwidth Reduction

Another effective noise reduction technique is the marker statistics function, which computes the average value of part or all of the formatted trace. Refer to "Using Markers".

## Average Menu

The average menu (Figure 7-32B) selects the desired noise-reduction technique, and sets the parameters for the technique selected. It is also used to set the aperture for group delay measurements.

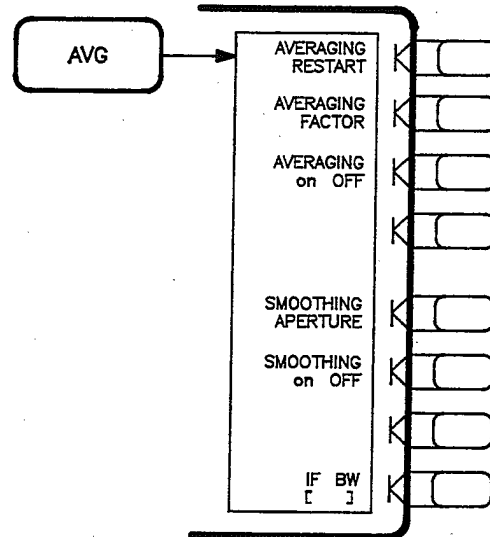

Figure 7-32B. Average Menu

**[AVERAGING RESTART]** (AVERREST) resets the sweep-to-sweep averaging and restarts the sweep count at 1 at the beginning of the next sweep. The sweep count for averaging is displayed at the left of the display.

**[AVERAGING FACTOR]** (AVERFACT) makes averaging factor the active function. Any value up to 999 can be used. The algorithm used for averaging is:

$$A(n) = S(n)/F + (1-1/F) \times A(n-1)$$

where

A(n) = current average

S(n) = current measurement

F = average factor

**[AVERAGING on OFF]** (AVERON, AVEROFF) turns the averaging function on or off for the active channel. "Avg" is displayed in the status notations area at the left of the display, together with the sweep count for the averaging factor, when averaging is on. The sweep count for averaging is reset to 1 whenever an instrument state change affecting the measured data is made.

At the start of averaging or following **[AVERAGING RESTART]**, averaging starts at 1 and averages each new sweep into the trace until it reaches the specified averaging factor. The sweep count is displayed in the status notations area below "Avg" and is updated every sweep. When the specified averaging factor is reached, the trace data continues to be updated, weighted by that averaging factor.

**[SMOOTHING APERTURE]** (SMOOPER) lets you change the value of the smoothing aperture as a percent of the span. When smoothing aperture is the active function, its value in stimulus units is displayed below its percent value in the active entry area.

Smoothing aperture is also used to set the aperture for group delay measurements (refer to *Group Delay Principles* earlier in this chapter). Note that the displayed smoothing aperture is not the group delay aperture unless smoothing is on.

**[SMOOTHING on OFF]** (SMOON, SMOOFF) turns the smoothing function on or off for the active channel. When smoothing is on, the annotation "Smo" is displayed in the status notations area.

**[IFBW]** (IFBW) selects the bandwidth value for IF bandwidth reduction. Allowed values (in Hz) are 3000, 1000, 300, 100, 30, and 10. Any other value will default to the closest allowed value. A narrow bandwidth slows the sweep speed but provides a better signal-to-noise ratio. The selected bandwidth value is shown in brackets in the softkey label.

# CAL KEY MENU MAP

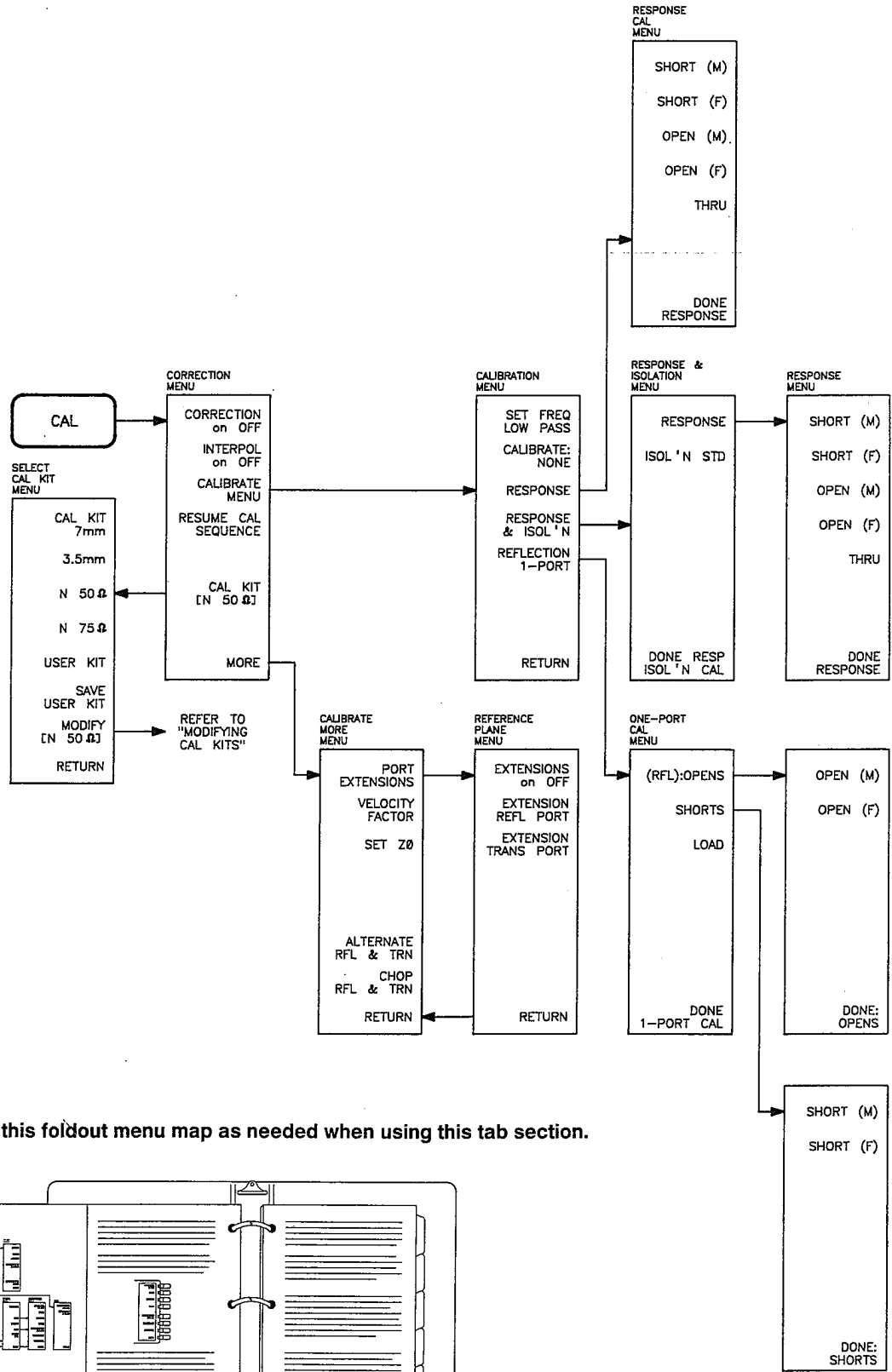

Refer to this foldout menu map as needed when using this tab section.

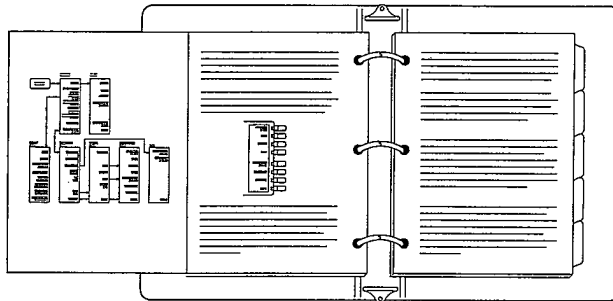

Figure 7-33. Cal Key Menu Map

# Measurement Calibration

## CONTENTS

7-34	What is Measurement Calibration?
7-34	Built-In vs User-Performed Measurement Calibration
7-34	When a User-Performed Calibration is Necessary
7-35	Measurement Calibration Theory
7-36	Sources of Measurement Errors
7-39	Reducing Measurement Errors
7-40	When measuring Response vs Frequency with a Polar or Smith Chart Display: Why Some Calibration Standards Exhibit a Curved Response
7-43	Menus and Softkeys
7-43	<b>[CAL]</b> Key
7-43	Interpolated Error Correction
7-45	Correction Menu
7-46	Cal Kit Menu
7-47	Calibrate More Menu
7-49	Reference Plane Menu
7-50	Calibration Menu
7-51	Purpose and Use of Different Calibration Procedures (table)
7-52	Modifying Calibration Kits
7-53	Modify Cal Kit Menu
7-55	Define Standard Menu
7-58	Specify Offset Menu
7-59	Label Standard Menu
7-60	Specify Class Menus
7-62	Label Class Menus
7-62	Label Kit Menu
7-65	Appendix to Measurement Calibration
7-65	Reflection Error Model
7-70	Transmission Error Model

## WHAT IS MEASUREMENT CALIBRATION?

**NOTE:** In this document, the word *cal* is sometimes used instead of *measurement calibration*.

Measurement calibration is a feature which improves measurement accuracy. It does this by measuring repeatable systematic errors and mathematically removing their effects from the measured data. There is actually more than one measurement calibration feature in this instrument:

- **Built-in calibration** (requires no action on the part of the operator). The built-in calibration has certain requirements which must be met. These requirements are explained in “When a User-Performed Calibration is Necessary”.
- **Three user-performed calibrations** are available for instances where external adapters, extra test cables, or other external test accessories are connected. These calibrations guide the operator through the calibration procedure. Normally a user-performed calibration will not tolerate changes to stimulus settings (for example, changing frequency range or number of points). Such changes turn the calibration off immediately. Such changes are possible using the following feature:
- **Interpolated error correction** allows a user-performed calibration to be valid after changing stimulus settings. When this feature is turned on, you can use a narrower stimulus span than was originally selected. In addition, you can increase or decrease the number of points used.

This section explains the theoretical fundamentals of accuracy enhancement and the sources of measurement errors. It also provides in depth information on the theory behind measurement calibration.

The types of user-performed calibration procedures are explained, along with the types of errors they correct, and the measurements for which each should be used. An appendix at the end of this chapter provides further information on characterizing systematic errors.

## BUILT-IN VS USER-PERFORMED MEASUREMENT CALIBRATION

The HP 8752 contains a built-in calibration feature which compensates for repeatable system errors caused by the analyzer, the analyzer’s test port connectors, and the test cable. Under some circumstances (explained below) your test setup may introduce other devices which create additional errors. When this occurs, you can remove the errors caused by the extra devices by performing your own measurement calibration. Three types of user-performed calibrations are available, each having different levels of complexity and equipment requirements. The *User’s Guide* explains how to perform your own calibrations, and explains which errors are corrected by each type. This chapter provides more in depth calibration theory, but does not explain how to perform a cal.

## WHEN A USER-PERFORMED CALIBRATION IS NECESSARY

If all of the following conditions are met, the analyzer can provide highly accurate measurements using its own built-in accuracy enhancement.

- The DUT is connected directly to the reflection port with no adapters or intervening cables.
- The DUT is designed for use in a 50 ohm system (for HP 8752A) or a 75 ohm system (for HP 8752B).
- In transmission measurements, the supplied test cable connects the DUT to the transmission port with no intervening cables or adapters.

**If your test setup meets these conditions, you do not need additional accuracy enhancement procedures.**

**If your test setup does not meet these conditions.** For various reasons your test setup may not meet these conditions. Examples are:

- You must adapt to a different connector type or impedance.
- You must connect a cable between the DUT and the reflection port.
- You must use a test cable other than the cable supplied with the HP 8752.
- An attenuator or other device must be connected on the input or output of the DUT.

If any of these are true of your measurement setup, you can improve the accuracy of your measurements with accuracy enhancement procedures.

## **MEASUREMENT CALIBRATION THEORY**

The analyzer has several methods of measuring and compensating for test system errors. Each method removes one or more of the systematic errors using an equation called an error model. Measurement of high quality standards such as a precision short, open and load allows the analyzer to solve for the error terms in the error model. The accuracy of the calibrated measurements is dependent on the quality of the standards used for calibrating. Since calibration standards are very precise, greater accuracy is achieved.

When a measurement calibration compensates for system errors, the dynamic range and accuracy of the measurement are limited only by these factors:

- System noise and stability
- Connector repeatability
- The accuracy to which the characteristics of the calibration standards are known.

### **Types of User-Performed Measurement Calibrations**

There are three types of measurement calibration available on the HP 8752:

- Response
- Response and Isolation
- Reflection 1-Port

Each type corrects for specific measurement errors. The sources of measurement errors are explained below. Each source of measurement error is described, along with the recommended user-performed measurement calibration.



## Sources of Measurement Errors

Network analysis measurement errors can be separated into systematic, random, and drift errors.

**Systematic errors.** Systematic errors are repeatable system errors. The analyzer can measure all systematic errors except load match, and reduce their effects. Systematic errors are:

- Directivity.
- Source match.
- Load match.
- Isolation (crosstalk).
- Tracking.

These errors are usually much greater than random or drift errors. Most systematic errors can be measured and their effects minimized. Each type of error is explained below.

**Random and drift errors.** Random and drift errors are the non-repeatable errors that the system itself cannot measure, and therefore cannot be corrected. Random errors are caused by system noise and connector repeatability. Drift errors are caused by temperature drift.

### Directivity

Normally a device that can separate the reverse from the forward traveling waves (a directional bridge or coupler) is used to detect the signal reflected from the device under test. Ideally the coupler would completely separate the incident and reflected signals, and only the reflected signal would appear at the coupled output, as illustrated in Figure 7-34a.

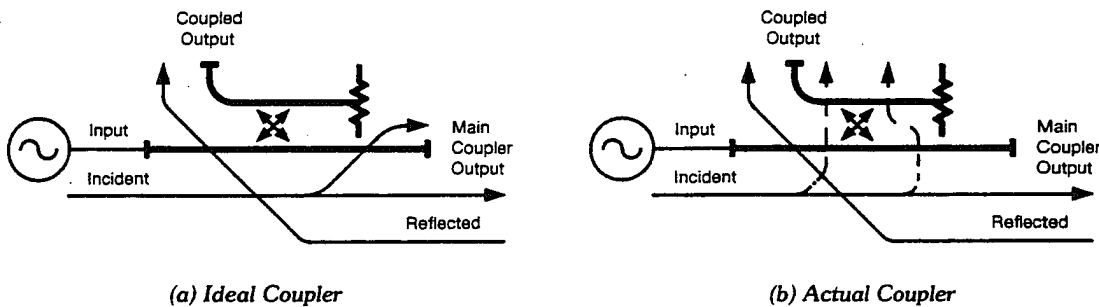

Figure 7-34. Directivity

However, a real coupler is not perfect, as illustrated in Figure 7-34b. A small amount of the incident signal appears at the coupled output due to leakage as well as to reflection from the termination in the coupled arm. Also, reflections from the main coupler output connector appear at the coupled output, adding uncertainty to the signal reflected from the coupler. The figure of merit for how well a coupler separates forward and reverse waves is directivity. The greater the directivity of the device, the better the signal separation. Directivity is the vector sum of all leakage signals appearing at the network analyzer receiver input due to the inability of the signal separation device to absolutely separate incident and reflected waves, and to residual reflection effects of test cables and adapters between the signal separation device and the measurement plane. The error contributed by directivity is independent of the characteristics of the test device and it usually produces the major ambiguity in measurements of low reflection devices. Directivity errors caused by the analyzer's internal components and test ports are corrected by the built-in calibration. External devices cause additional directivity errors, which can be corrected by a Response and Isolation calibration, or by a Reflection 1-Port calibration.

## Source Match

Source match is defined as the vector sum of signals appearing at the network analyzer receiver input due to the impedance mismatch at the test device looking back into the source. Source match is degraded by adapters and extra cables. A non-perfect source match leads to mismatch uncertainties that affect both transmission and reflection measurements. Source match is most often given in terms of return loss in dB: thus the larger the number, the smaller the error.

**Source match in reflection measurements.** In a reflection measurement, the source match error signal is caused by some of the reflected signal from the DUT being reflected from the source back towards the DUT and re-reflected from the DUT (Figure 7-35). The built-in cal corrects for source match errors in reflection measurements, but only under the conditions stated at the beginning of this chapter. If the measurement setup does not meet the previously stated conditions, perform a reflection 1-port calibration to compensate for source match errors.

**Source match in transmission measurements.** In a transmission measurement, the source match error signal is caused by reflection from the test device that is re-reflected from the source.

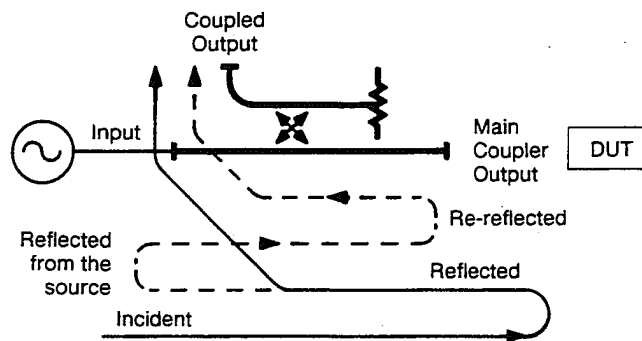

Figure 7-35. Source Match

The error contributed by source match is a mismatch error caused by the relationship between the actual input impedance of the test device and the equivalent match of the source. Mismatch uncertainty is particularly a problem in measurements where there is a large impedance mismatch at the measurement plane.

## Load Match

In transmission measurements there is an additional mismatch uncertainty due to the output match of the DUT and the load match of the transmission port. The mismatch uncertainty is larger when measuring a two-port DUT with a highly reflective output port.

As illustrated in Figure 7-36, some of the transmitted signal is reflected from the transmission port back to the test device. A portion of this wave may be re-reflected to the transmission port, or part may be transmitted through the device in the reverse direction to appear at the reflection port. Any signal that is reflected back to the reflection port can contribute to measurement uncertainty when making reflection measurements. This effect is reduced as the loss through the DUT increases. Load match is usually given in terms of return loss in dB: thus the larger the number, the smaller the error.

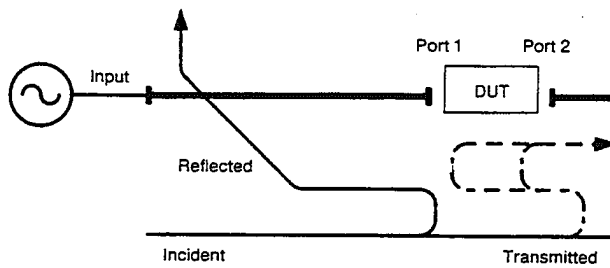

Figure 7-36. Load Match

The error contributed by load match is dependent on the relationship between the actual output impedance of the test device and the match of the transmission port. Load match is a factor in transmission measurements and can be a factor in reflection measurements of two-port devices.

The HP 8752 cannot compensate for load match errors.

### Isolation (Crosstalk)

Leakage of energy between network analyzer signal paths contributes to error in a transmission measurement much like directivity does in a reflection measurement. Isolation is the vector sum of signals appearing at the network analyzer samplers due to crosstalk between the reference and test signal paths, including signal leakage in both the RF and IF sections of the receiver.

**Low loss devices.** Isolation errors are negligible in measurements of DUTs with low transmission loss, and correction is not necessary.

**High loss devices.** Isolation is a factor in measurements of the transmission characteristics of a high-loss DUT. However, analyzer system isolation is more than sufficient for most measurements, and correction for it may be unnecessary. For measuring devices with high dynamic range, a response and isolation calibration can provide improvements in isolation that are limited only by the noise floor of the measurement system.

**When to use a Response and Isolation calibration.** The following criteria determines the need for a Response and Isolation calibration:

- **Which is greater, crosstalk error or noise floor?** Connect a short to the Transmission Port and a load to the Reflection Port (these devices must be from a cal kit). Try to lower the instrument's "noise floor" using averaging or a narrower IF bandwidth. If you succeed, crosstalk is less than the noise floor and you do not need to perform a Response and Isolation cal. In this case, dynamic range is limited by system noise, not by crosstalk errors.

If the instrument's "noise floor" is not affected by averaging or IF bandwidth, then a Response and Isolation cal can reduce crosstalk error.

## Tracking

This is the vector sum of variations between the reference path and test signal path. Reflection tracking is the (magnitude and phase) errors seen when making a reflection measurement, Transmission tracking are the errors seen when making a transmission measurement. The analyzer handles these two errors separately.

Transmission and reflection tracking errors are reduced by the built-in calibration. If you do not meet the built-in calibration's requirements (refer to the beginning of this chapter), perform a Response or Response and Isolation calibration to correct for tracking errors.

For further explanation of systematic error terms and the way they are combined and represented graphically in error models, refer to the appendix at the end of this chapter, titled *Accuracy Enhancement Fundamentals – Characterizing Systematic Errors*.

## REDUCING MEASUREMENT ERRORS

The analyzer can reduce directivity, source match, isolation, and tracking errors. The analyzer has several different measurement calibration routines to characterize one or more of the systematic error terms and reduce their effects on the measured data.

**Where to find step-by-step instructions.** Step-by-step instructions for performing the following calibrations are provided in "Getting the Most out of Your Network Analyzer" in the *User's Guide*.

**The Response Calibration.** Minimizes tracking errors of the test setup for reflection or transmission measurements. There are two types of Response calibration, one for transmission and one for reflection measurements.

**The Response and Isolation Calibration.** minimizes tracking and crosstalk errors in transmission measurements, or tracking and directivity errors in reflection measurements.

**The Reflection 1-Port Calibration.** provides directivity, source match, and tracking vector error correction for reflection measurements. This procedure provides high accuracy reflection measurements of one-port devices or properly terminated multi-port devices.

All the calibration procedures described above are accessed from the [CAL] key and are described in the following pages.

## When Using a Male Test Port

If (by adding an adapter, cable, etc) you change the reflection port to a male connector, this paragraph pertains to you. Type-N and 3.5 mm calibration kits provide open circuits with center conductor extenders. For maximum accuracy when calibrating with an open, place the extender on the male test port center conductor. Push gently until the center conductors mate, then press **[OPEN (M)]**. It does not matter which you place on the test port first, the precision open or the center conductor extender. Use whatever sequence is most convenient, so long as both are in place when you press **[OPEN (M)]**.

## When Measuring Response vs Frequency with Polar or Smith Chart Display: Why Some Calibration Standards Exhibit a Curved Response

In order for the response of a reference standard to show as a single point on the display, it must have no phase shift with respect to frequency. Standards that exhibit such "perfect" response are:

- 7 mm short (with no offset)
- Type-N female short (with no offset)

There are two reasons why other types of reference standards show phase shift after calibration:

- The shorting plane of the standard is electrically offset from the reference plane of the test port. Such devices exhibit the properties of a small length of transmission line, including a certain amount of phase shift.
- The standard is an open, which by definition exhibits a certain amount of fringe capacitance (and therefore phase shift). Open standards which are offset from the mating plane will exhibit a phase shift due to the offset in addition to the phase shift caused by the fringe capacitance.

**The most important point to remember is that these properties will not affect your measurements.** The analyzer has modeled the effects and accounts for them during the accuracy enhancement process. Figure 5-37 shows sample displays of various calibration standards after calibration.

**Electrical Offset.** Some standards have reference planes that are electrically offset from the mating plane of the test port. These devices will show a phase shift with respect to frequency. The master reference table (7-1) shows which reference devices exhibit an electrical offset phase shift. The amount of phase shift can be calculated with the formula:

$$\phi = (360 \times f \times l) / c \text{ where:}$$

f = frequency

l = electrical length of the offset

c = speed of light ( $3 \times 10^8$  meters/second).

**Fringe Capacitance.** All open terminations exhibit a phase shift over frequency due to fringe capacitance. Offset open terminations additionally have increased phase shift because the offset acts as a small length of transmission line. Refer to Table 7-1.

Table 7-1. Master Reference Table Showing Calibration Standard Types and Expected Phase Shift

Test Port <sup>1</sup> Connector Type	Standard Type	Expected Phase Shift
7 mm type-N male	Short	180° (ideal)
3.5 mm male 3.5 mm female type-N female	Offset Short	$180^\circ + (360 \times f \times l)/c$
7 mm type-N male	Open	$0^\circ + \varphi_{\text{capacitance}}$
3.5 mm male 3.5 mm female type-N female	Offset Open	$0^\circ + \varphi_{\text{capacitance}} + (360 \times f \times l)/c$
1. The "test port" is the connector which will later connect directly to the DUT. This may be the Reflection Port, or it may be the output connector of any adapter, cable, or attenuator attached to the Reflection Port.		

**NOTE:** During the Reflection 1-Port calibration procedure, **[OPEN (M)]** **[OPEN (F)]** **[SHORT (M)]** or **[SHORT (F)]** refer to the sex of the test port and not the sex of the calibration standard. For example, if using an open (male) standard on a female test port, choose **[OPEN (F)]**.

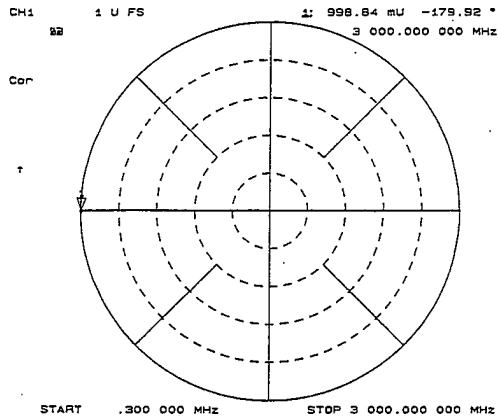

**Applicable Standards:**  
 7mm short

Type-N female short (no offset)  
 (Male test port)

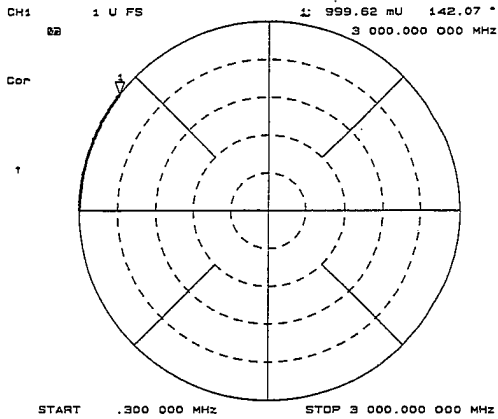

**Applicable Standards:**  
 Type-N male offset short  
 (Female test port)

3.5 mm male or female  
 offset short

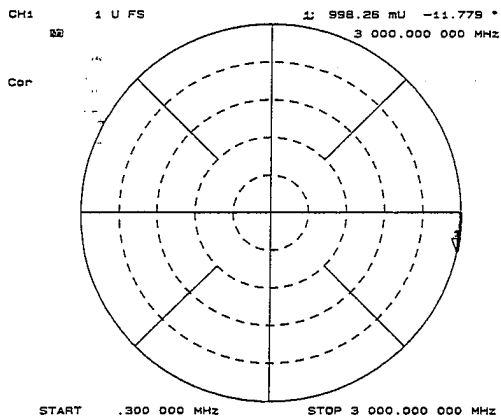

**Applicable Standards:**  
 7 mm open (no offset)

Type-N female open (No Offset)  
 (Male Test Port)

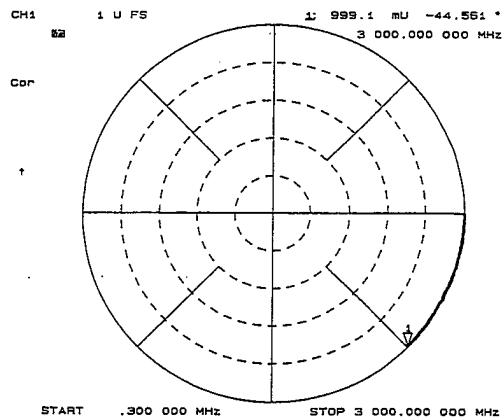

**Applicable Standards:**  
 Type-N Male offset open  
 (Female test port)

3.5 mm Male or Female  
 Offset Open

Figure 7-37. Typical Responses of Calibration Standards after Calibration

## MENUS AND SOFTKEYS

### [CAL] Key

The [CAL] (MENCAL) key leads to a series of menus that implement the user-performed measurement calibration procedures described in the preceding pages (see Figure 5-33, the fold-out at the beginning of this section).

**Standard Devices.** The standard devices required for user-performed calibrations are available in calibration kits. A different kit is required for each different connector type. The model numbers and contents of these calibration kits are listed in the General Information section of this manual, and at the end of the *User's Guide*. Non-HP standard devices can be used by specifying their characteristics in a user-defined kit, as described later in this chapter under *Modifying Calibration Kits*.

The accuracy improvement achieved by a calibration is limited by the quality of the standard devices, and by the connection techniques used. For information about connector care and connection techniques, refer to the application note, *Principles of Microwave Connector Care*, provided in this manual. When possible, use a torque wrench for connections. The techniques for torquing connections and the part numbers for torque wrenches recommended for different connector types are provided in the connector care document mentioned above.

**Calibration Validity.** Unless interpolated error correction is on, user-performed measurement calibrations are valid only for a specific stimulus state, which must be set before calibration is begun. The stimulus state consists of the selected frequency range, number of points, sweep time, output power, and sweep type. Changing the frequency range, number of points, or sweep type turns calibration off. If this occurs, you can press [CORRECTION ON] to recall the original stimulus state and reactivate the calibration.

**Interpolated Error Correction.** The interpolated error correction feature allows the operator to select a subset of the frequency range or a different number of points without recalibration. Interpolation must be activated by softkey before it will function. When interpolation is on, the system errors for the newly selected frequencies are interpolated from the system errors of the original (user-performed) calibration.

System performance is unspecified when using interpolated error correction. The quality of the interpolated error correction is dependent on the amount of phase shift and the amplitude change between measurement points. If phase shift is no greater than 180° per approximately 5 measurement points, interpolated error correction offers a great improvement over uncorrected measurements. The accuracy of interpolated error correction improves as the phase shift and amplitude change between adjacent points decrease. Another way to ensure good performance is to perform the original calibration with at least 67 points per 1 GHz of frequency span.

Interpolated error correction functions in three sweep modes: linear frequency, power sweep, and CW time.

**Channel Coupling.** Up to two sets of measurement calibration data can be defined for each instrument state (one for each channel). If the two channels are stimulus coupled and the same type of measurement is used in both channels (both are making a transmission measurement, for example), the two channels share the same calibration data. If different types of measurements are being made on each channel (transmission on one, reflection on the other), they can have different calibration data. If the two channels are stimulus uncoupled, the measurement calibration applies to only one channel. For information on stimulus coupling, refer to Chapter 8, "Stimulus Function Block".



**Measurement Parameters.** Calibration procedures are parameter-specific, rather than channel-specific. When a parameter is selected, the instrument checks the available calibration data, and uses the data found for that parameter. For example, if a Response calibration is performed for TRANSMISSION, and a Reflection 1-Port calibration for REFLECTION, the analyzer retains both calibration sets and corrects whichever parameter is displayed. Once a calibration has been performed for a specific parameter or input, measurements of that parameter remain calibrated in either channel (as long as stimulus values are coupled). In the Response and Response and Isolation calibrations, the parameter must be selected before calibration: The Reflection 1-Port procedure selects parameters automatically. Changing channels during a calibration procedure invalidates the part of the procedure already performed.

**Device Measurements.** In the Reflection 1-Port calibration, several different devices must be used, a short, an open, and a load. The order in which the devices are measured is not critical. Any standard can be re-measured, until the **[DONE]** key is pressed for the entire calibration.

Response calibrations require measurement of only one standard device. If more than one device is measured, only the data for the last device is retained.

**Stopping During the Calibration Procedure.** You can stop at any point during a calibration procedure, without losing the steps you have already performed. No special steps are necessary to leave; just do whatever task you want. To continue the calibration where you left off, press **[CAL] [RESUME CAL SEQUENCE]**.

**Saving Calibration Data.** It is recommended that calibration data be saved, either in internal volatile memory or on an external disk. Refer to "Save and Recall" in Chapter 10. If a calibration is not saved, it will be lost if another calibration procedure is selected for the same channel. Performing an instrument preset, turning power off, or recalling an instrument state will also clear the calibration data.

**Specifying Calibration Kits.** In addition to the menus for the different calibration procedures, the **[CAL]** key provides access to a series of menus used to specify the characteristics of the calibration standards used. Hewlett-Packard calibration kits are predefined.

## Correction Menu

The correction menu is the first menu presented by the [CAL] key, and it provides access to numerous menus of additional calibration features.

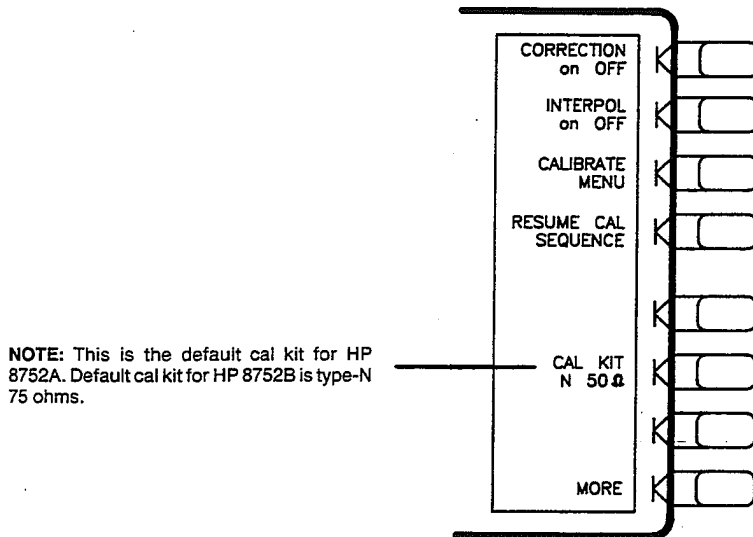

NOTE: This is the default cal kit for HP 8752A. Default cal kit for HP 8752B is type-N 75 ohms.

Figure 7-38. Correction Menu

**[CORRECTION on OFF]** (CORRON, CORROFF) turns error correction on or off. The analyzer uses the most recent calibration data for the displayed parameter. If the stimulus state has been changed since calibration, the original state is recalled, and the message "SOURCE PARAMETERS CHANGED" is displayed.

A calibration must be performed before correction can be turned on. If no valid calibration exists, the message "CALIBRATION REQUIRED" is displayed. If interpolated error correction is on, this message is not displayed if you have selected a subset of a previously calibrated frequency range. See the **[INTERPOL on OFF]** description, below.

It is recommended that calibration data be saved, either in internal volatile memory or on an external disk, using capabilities described in "Save and Recall."

**[INTERPOL on OFF]** (CORION, CORIOFF) turns interpolated error correction on or off. The interpolated error correction feature allows the operator to calibrate the system, then select a subset of the frequency range or a different number of points. Interpolated error correction functions in linear frequency, power sweep, and CW time modes. If the analyzer is used in linear sweep mode, the original calibration should be performed with at least 67 points per 1 GHz of frequency span.

**[CALIBRATE MENU]** leads to the calibration menu, which provides several accuracy enhancement procedures. At the completion of a calibration procedure, this menu is returned to the screen, correction is automatically turned on, and the notation "Cor" is displayed on the left edge of the display.

**[RESUME CAL SEQUENCE]** (RESC) eliminates the need to restart a calibration sequence that was interrupted to access some other menu. This softkey goes back to the point where the calibration sequence was interrupted.

[CAL KIT] leads to the select cal kit menu, which is used to select one of the default analyzer compatible calibration kits available for different connector types. This in turn leads to additional menus used to define calibration standards other than those in the default kits (refer to "Modifying Calibration Kits", later in this chapter). When a calibration kit has been specified, its connector type is displayed in brackets in the softkey label.

[MORE] provides access to the calibrate more menu, which is used to extend the test port reference plane, to specify the characteristic impedance of the system, to select the optimum receiver sweep mode, and to specify the relative propagation velocity factor for distance-to-fault measurements using the time domain option.

## Cal Kit Menu

The cal kit menu selects the calibration kit to be used for a measurement calibration. Selecting a cal kit chooses the *model* that mathematically describes the standard devices actually used. (Refer to the beginning of this chapter, and the appendix at the end of this chapter, for more background on measurement calibrations and error correction.)

The analyzer has the capability to calibrate with four predefined cal kits in four different connector types. The models for these cal kits correspond to the standard calibration kits available as accessories for the analyzer:

- 7 mm HP 85031B 50 ohm 7 mm calibration kit
- 3.5 mm HP 85033C 50 ohm 3.5 mm calibration kit (standard or option 001)
- N 50Ω HP 85032B 50 ohm type-N calibration kit (standard or option 001)
- N 75Ω HP 85036B 75 ohm type-N calibration kit

How closely must the model match the actual device? The answer depends on the accuracy required.

In addition to the four predefined cal kits, a fifth choice is a "user kit" that is defined or modified by the user. This is described under "Modifying Calibration Kits" later in this chapter.

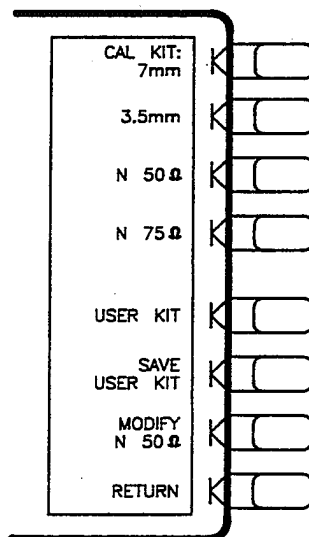

Figure 7-39. Select Cal Kit Menu

**[CAL KIT: 7mm]** (CALK7MM) selects 7 mm cal kit model.

**[3.5mm]** (CALK35MM) selects the 3.5 mm cal kit model.

**[N 50Ω]** (CALKN50) selects the 50 ohm type-N model.

**[N 75Ω]** (CALKN75) selects the 75 ohm type-N model.

**NOTE:** If **[N 50Ω]** or **[N 75Ω]** is selected, additional menus are provided during calibration procedures to select the connector sex. *These menus require you to indicate the sex of the test port, not the sex of the calibration device.* The test port is defined as the connector that will later attach directly to the DUT. This would be the Reflection Port itself unless you are using an adapter, cable, or other external test accessory.

**[USER KIT]** (CALKUSED) selects a cal kit model defined or modified by the user. For information, refer to *Modifying Calibration Kits*, later in this chapter.

**[SAVE USER KIT]** (SAVEUSEK) stores the user-modified or user-defined kit into memory.

**[MODIFY]** (MODI1) leads to the modify cal kit menu, where a predefined cal kit can be user-modified.

**[RETURN]** returns to the correction menu.

## Calibrate More Menu

This menu is used to extend the test port reference plane, to specify the characteristic impedance of the system, to select the optimum receiver sweep mode, and to specify the relative propagation velocity factor for distance-to-fault measurements.

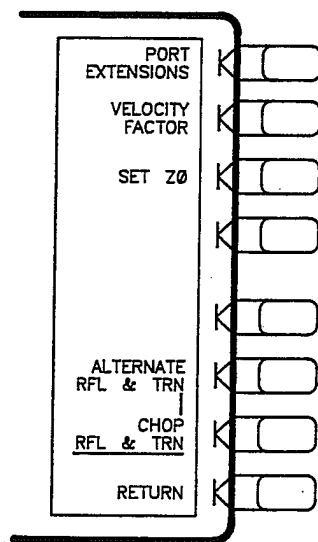

Figure 7-40. Calibrate More Menu

**[PORT EXTENSIONS]** goes to the reference plane menu, which extends the apparent location of the measurement reference plane or input.

**About Port Extensions.** The built-in calibration compensates for the electrical length of the supplied test cable. If you add devices to the basic instrument setup (explained at the beginning of this section), a user-performed calibration can compensate for the devices' electrical lengths. Why do you need Port Extensions? When measuring *non-insertable* devices. A non-insertable device is any DUT that creates the following connector problems:

- One or more connectors on the DUT require an adapter to mate with the Reflection Port or the supplied test cable and:
- Adding this required adapter would make it impossible to connect the test connections together without the DUT.

The built-in calibration does not compensate for electrical length of the extra adapter, so port extensions is required.

If you perform your own calibration, the adapter must be added *after* the calibration. Therefore port extensions is required to compensate for its additional electrical delay.

The differences between the **[PORT EXTENSIONS]** and **[ELECTRICAL DELAY]** functions are shown below:

Table 7-2. Differences between **[PORT EXTENSIONS]** and **[ELECTRICAL DELAY]**

	<b>[PORT EXTENSIONS]</b>	<b>[ELECTRICAL DELAY]</b>
<b>Main Effect</b>	The end of a cable or adapter becomes the test port plane for both reflection and transmission measurements.	Compensates for the electrical length of a cable for the current type of measurement only. Reflection = 2 times cable's electrical length. Transmission = 1 times cable's electrical length.
<b>Measurements Affected</b>	Transmission or reflection measurements.	Only the currently selected measurement, transmission or reflection.
<b>Electrical Compensation</b>	Automatically compensates for 1 times or 2 times the cable's electrical delay, depending on which measurement type is selected, transmission or reflection.	Only compensates as necessary for the currently selected measurement type.

**[VELOCITY FACTOR]** (VELOFACT) Enters the velocity factor used by the analyzer to calculate equivalent electrical length in distance-to-fault measurements using the time domain option. Values entered should be less than 1. For example, the velocity factor of Teflon is:

$$V_f = \frac{1}{\sqrt{\epsilon_R}} = 0.666$$

**[SET Z0]** (SETZ) sets the characteristic impedance used by the analyzer in calculating measured impedance with Smith chart markers and conversion parameters. Characteristic impedance must be set correctly before calibration procedures are performed.

**[ALTERNATE RFL & TRN]** (ALTAB) Alternates measurements between the Reflection Port and Transmission Port on each frequency sweep in order to reduce spurious signals. This mode optimizes dynamic range.

The disadvantages of this mode are associated with simultaneous transmission/reflection measurements: this mode takes twice as long as the chop mode to make these measurements.

**[CHOP RFL and TRN]** (CHOPAB) simultaneously measures both Transmission and Reflection Ports during each sweep. Thus, if each channel is measuring a different parameter and both channels are displayed, the chop mode offers the fastest measurement time. This is the default mode.

The disadvantage of this mode is that in measurements of high rejection devices, such as filters with a low-loss passband (>400 MHz wide), analyzer dynamic range may be reduced.

**[RETURN]** goes back to the correction menu.

## Reference Plane Menu

This menu adds electrical delay (in seconds) to the measurement ports to extend the apparent location of the measurement reference plane to the ends of any extra adapters or cables. This is equivalent to adding a length of perfect air line, and makes it possible to measure the delay response of the DUT only instead of the DUT plus the adapter, cable or other incidental device. Read the previous description of Port Extensions for more information.

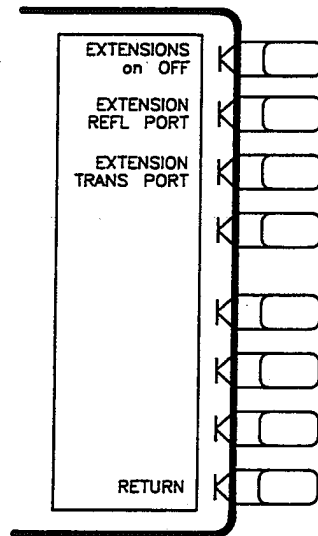

Figure 7-41. Reference Plane Menu

**[EXTENSIONS on OFF]** (POREON, POREOFF) toggles the reference plane extension mode. When this function is on, all extensions defined below are enabled; when off, none of the extensions are enabled.

**[EXTENSION REFL PORT]** (PORTR). Use this feature to add electrical delay (in seconds) to extend the Reflection Port's reference plane to the end of an adapter or cable.

**[EXTENSION TRANS PORT]** (PORTT) adds electrical delay (in seconds) to extend the Transmission Port's reference plane to the end of an adapter or additional cable.

**[RETURN]** goes back to the calibrate more menu.

## Calibration Menu

The calibration menu selects the type of measurement calibration you wish to perform. Each calibration procedure guides you through the selected calibration sequence. The available calibrations are described below, and a comparative summary is provided in Table 7-3. Procedures for performing each of the calibrations are provided in "Getting the Most out of Your Network Analyzer" in the *User's Guide*.

Note that all instrument parameters should be established before a calibration procedure is started, including stimulus values, calibration kit, system characteristic impedance  $Z_0$ , and receiver sweep mode. (To modify the characteristic impedance and receiver sweep mode, refer to *Calibrate More Menu*.) When interpolated error correction is on (and you are in linear frequency sweep, power sweep, or CW time sweep), you can choose a subset of frequency range or a different number of points after the system has been calibrated. The performance of interpolated error correction is not specified.

For measurement of test devices following calibration, refer to the *User's Guide*.

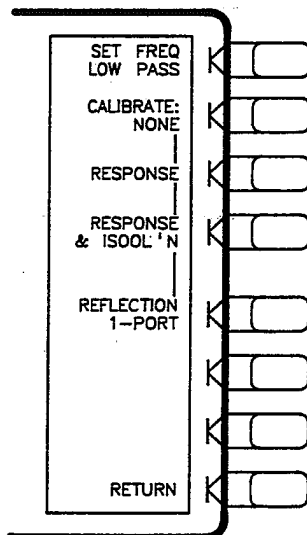

Figure 7-42. Calibration Menu

**[SET FREQ LOW PASS]** changes the frequency sweep to harmonic intervals to accommodate time domain low-pass operation (option 010). If this mode is to be used, the frequencies must be set before calibration. Refer to "Time Domain", for more information.

**[CALIBRATE: NONE]** is underlined if no calibration has been performed or if the calibration data has been cleared.

**[RESPONSE]** (CALIRESP) leads to the response calibration. This is the simplest and fastest accuracy enhancement procedure. It effectively sets the 0 dB (magnitude) and 0 degree (phase) reference level for transmission or reflection measurements.

For transmission-only measurements or reflection-only measurements, a single calibration standard is required with this procedure. The standard for transmission measurements is a test cable (called a *thru*). The standard for reflection measurements can be either an open or a short. The procedures for response calibrations are described in the *User's Guide*.

**[RESPONSE & ISOL'N]** (CALIRAI) leads to the menus used to perform a response and Isolation calibration, for measurement of devices with wide dynamic range. This procedure reduces the same errors as the response calibration. In addition, it can reduce the isolation (crosstalk) error in transmission measurements or the directivity error in reflection measurements.

This type of calibration is usually not needed. Read "When to use a Response and Isolation calibration", near the beginning of this chapter.

In addition to the devices required for a response calibration, an isolation standard is required (an impedance-matched load). Response and Isolation calibration procedures for reflection and transmission measurements are provided in the *User's Guide*.

**[REFLECTION 1-PORT]** (CALIS111) provides a measurement calibration for reflection-only measurements of one-port devices or properly terminated multi-port devices. The cal is performed on the Reflection Port. This procedure reduces the directivity, source match, and tracking errors of the test setup, and provides a higher level of measurement accuracy than the Response and Isolation calibration. It is the most accurate calibration procedure for reflection-only measurements. Three standard devices are required: a short, an open, and an impedance-matched load. The procedure for performing a Reflection 1-Port calibration is described in the *User's Guide*.

Table 7-3. Purpose and Use of Different Calibration Procedures

Calibration Procedure	Corresponding Measurement	Errors Reduced	Standard Devices
Response	Transmission: Reflection:	Tracking Tracking*	A thru An open or a short.
Response & Isolation	Transmission: (For high insertion loss devices.) Reflection: (For high return loss devices, not as accurate as Reflection 1-port cal.)	Tracking Isolation Tracking* Directivity	A thru and a load. A load, plus an open or a short.
Reflection 1-Port	Reflection of any one-port device or well terminated multi-port device. (This is the most accurate calibration for reflection measurements with the HP 8752A.)	Tracking Source Match Directivity	Short, open and load.
* Reflection 1-Port calibration provides greater reduction of tracking errors.			



## MODIFYING CALIBRATION KITS

**NOTE:** Hewlett-Packard strongly recommends that you read application note 8510-5A before attempting to view or modify calibration standard definitions. The part number of this application note is 5956-4352. Although the application note is written for the HP 8510 family of network analyzers, it also applies to this analyzer. This portion of the calibration chapter provides a summary of the information in the application note, as well as HP 8752-specific information.

For most applications, use the default cal kit models provided in the select cal kit menu described earlier in this chapter. Modifying calibration kits is necessary only if unusual standards are used or the very highest accuracy is required.

Unless a cal kit model is provided with the calibration devices used, a solid understanding of error correction and the system error model are absolutely essential to making modifications. Read the introductory part of this chapter for more information, and refer to the Appendix at the end of this section.

**NOTE:** Numerical data for most Hewlett-Packard calibration kits is provided in the calibration kit manuals.

During measurement calibration, the analyzer measures actual, well-defined standards and mathematically compares the results with ideal mathematical models of those standards. The differences are separated into error terms which are later removed during error correction. Most of the differences are due to systematic errors. These are repeatable errors introduced by the network analyzer, test cable, and external test devices (adapters, cables). Systematic errors are correctable. However, the difference between the standard's mathematical model and its actual performance has an adverse affect; it reduces the system's ability to remove systematic errors, and thus degrades error-corrected accuracy. Therefore, in addition to the predefined default cal kit models, a user kit is provided that can be modified to an alternate calibration standards model.

Several situations exist that may require a user-defined cal kit:

- You use a connector interface different from the four built-in cal kits. (Examples: TNC or waveguide.)
- You are using standards (or combinations of standards) that are different from the predefined cal kits. (Example: Using three offset shorts instead of open, short, and load to perform a 1-port calibration.)
- You want to improve the built-in standard models for predefined kits. Remember that the more closely the model describes the actual performance of the standard, the better the calibration. (Example: A type-N load is determined to be 50.4 ohms instead of 50.0 ohms.)
- Unused standards for a given cal type can be eliminated from the predefined set, to eliminate possible confusion during calibration. (Example: A certain application requires calibrating a male test port. The standards used to calibrate a female test port can be eliminated from the set, and will not be displayed during calibration.)

## Definitions

It is necessary to define some of the terms used:

- A *standard* is a specific, well-defined, physical device used to determine systematic errors.
- A *standard type* is one of five basic types that define the form or structure of the model to be used with that standard (e.g. short or load).
- *Standard coefficients* are numerical characteristics of the standards used in the model selected.
- A *standard class* is a grouping of one or more standards that determines which standards are used in a particular calibration procedure.

## Procedure

Use the following steps to modify or define a user kit:

1. Select the predefined kit to be modified. (This is not necessary for defining a new cal kit.)
2. Define the standards. For each standard, define which *type* of standard it is and its electrical characteristics.
3. Specify the *class* where the standard is to be assigned.
4. Store the modified cal kit.

Following the descriptions of the menus for modifying calibration kits, a procedure is provided that enters the HP 85033C 3.5 mm calibration kit values as a *user kit*.

## Modify Cal Kit Menu

This menu is accessed by pressing **[CAL] [CAL KIT] [MODIFY]**, and leads to additional menus associated with modifying cal kits. This analyzer can make error-corrected measurements in a variety of connector types, provided suitable calibration standards exist. The analyzer directly supports 7 mm, 3.5 mm, 50 ohm type-N, and 75 ohm type-N connector types.

For other connector types, including waveguide, you must modify the existing standards definitions. This menu provides access to the default calibration standards definitions. A "User Kit" is provided for convenience. It can be redefined without affecting the definitions for the existing calibration kits.

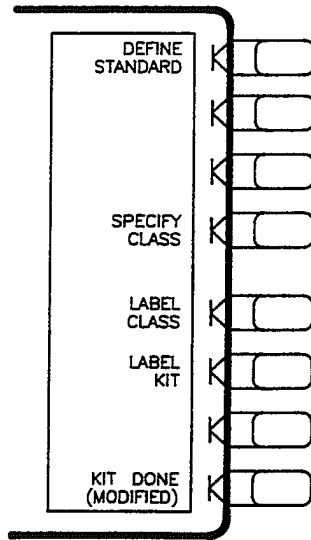

Figure 7-43. Modify Cal Kit Menu

**[DEFINE STANDARD]** (DEFS) The instrument has eight user-definable calibration standard *numbers*. Each is similar to a register, in that it holds certain information. Each standard number contains:

- The selected type of device (open, short, load, or thru).
- The electrical model for that device.

These standard numbers come defined with the following device types:

Standard Number	Predefined Standard Type
1	Short #1
2	Open #1
3	Broadband Load
4	Thru
5	Sliding Load
6	Lowband Load
7	Short #2
8	Open #2

**[SPECIFY CLASS]** leads to the specify class menu. After the standards are modified, use this key to specify a class to consist of certain standards.

**[LABEL CLASS]** leads to the label class menu, to give the class a meaningful label for future reference.

**[LABEL KIT]** (LABEK) leads to a menu for constructing a label for the user-modified cal kit. If a label is supplied, it will appear as one of the five softkey choices in the select cal kit menu. The approach is similar to defining a display title, except that the kit label is limited to ten characters. Refer to **[DISPLAY] Key, Title Menu** in Chapter 7 for details.

**[KIT DONE]** (KITD) terminates the cal kit modification process, after all standards are defined and all classes are specified. Be sure to save the kit with the **[SAVE USER KIT]** softkey, if it is to be used later.

## Define Standard Menus

Standard definition is the process of mathematically modeling the electrical characteristics (delay, attenuation, and impedance) of each calibration standard. These electrical characteristics (coefficients) can be mathematically derived from the physical dimensions and material of each calibration standard, or from its actual measured response. The parameters of the standards can be listed in *Standards Definitions*, Table 7-4. The menus illustrated in Figure 7-44 are used to specify the type and characteristics for each user-defined standard.

Table 7-4. Standard Definitions

STANDARD		C0 x10 <sup>-15</sup> F	C1 x10 <sup>-27</sup> F/Hz	C2 x10 <sup>-39</sup> F/Hz	C3 x10 <sup>-45</sup> F/Hz	FIXED OR SLIDING	OFFSET			FREQUENCY (GHz)		COAX or WAVEGUIDE	STANDARD LABEL
NO.	TYPE						DELAY ps	LOSS MΩ/s	Z <sub>0</sub> Ω	MINIMUM	MAXIMUM		
1													
2													
3													
4													
5													
6													
7													
8													

Each standard must be identified as one of five "types": open, short, load, delay/thru, or arbitrary impedance.

After a standard number is entered, selection of the standard type will present one of five menus for entering the electrical characteristics (model coefficients) corresponding to that standard type. These menus are tailored to the current type, so that only characteristics applicable to the standard type can be modified.

Any standard type can be further defined with offsets in delay, loss, and standard impedance; assigned minimum or maximum frequencies over which the standard applies; and defined as coax or waveguide. Press the **[SPECIFY OFFSET]** key, and refer to the specify offset menu.

A distinct label can be defined and assigned to each standard, so that the analyzer can prompt the user with explicit standard labels during calibration (e.g. "SHORT"). Press the **[LABEL STD]** softkey. The function is similar to defining a display title, except that the label is limited to ten characters. Refer to **[DISPLAY] Key, Title Menu** in Chapter 7 for details.

After each standard is defined, including offsets, press **[STD DONE (DEFINED)]** to terminate the standard definition.

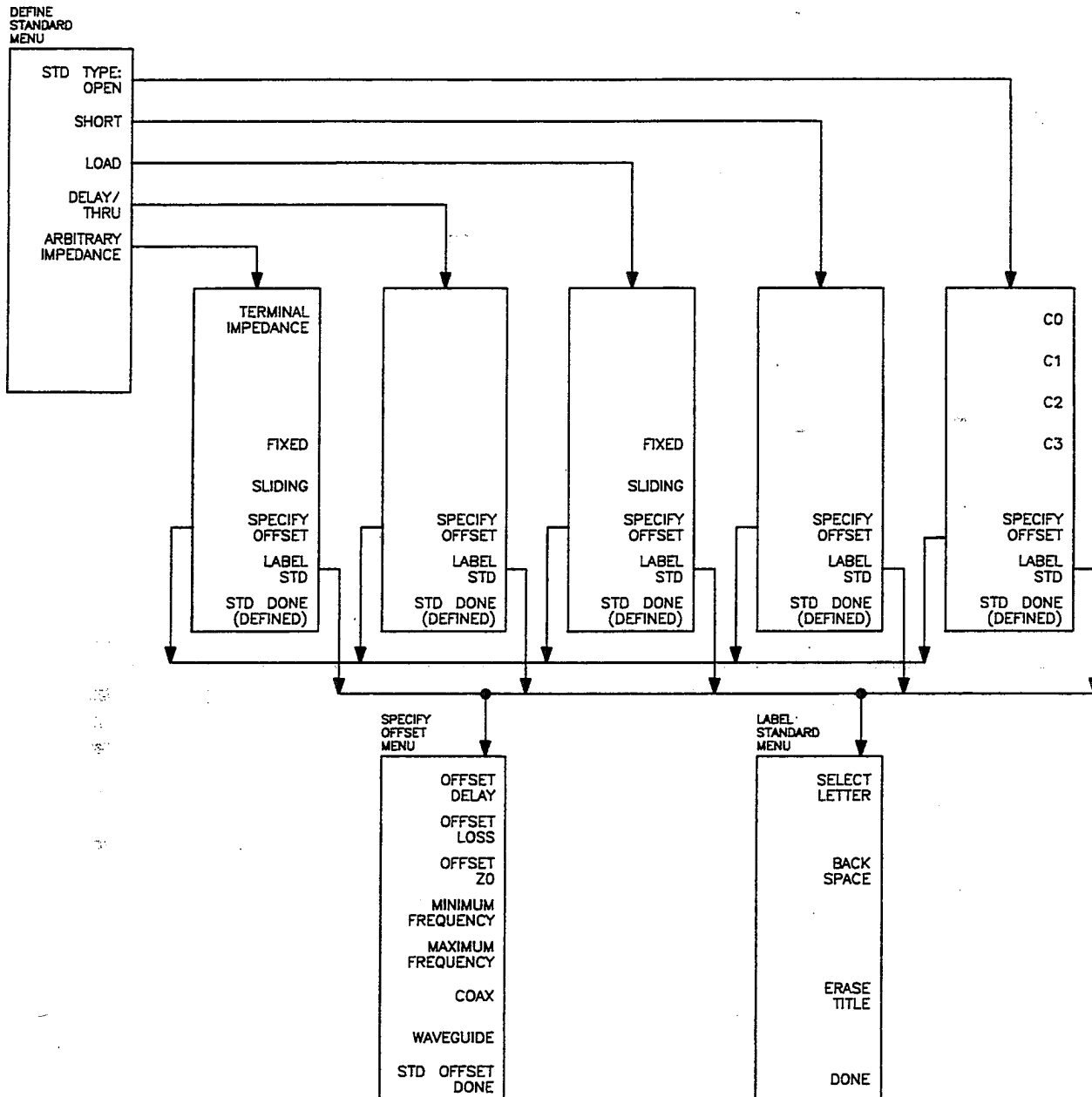

Figure 7-44. Define Standard Menus

**[OPEN]** (STDTOPEN) defines the standard type as an open, used for calibrating reflection measurements. Pressing this key also brings up a menu for defining the open, including its capacitance.

As a reflection standard, an open termination offers the advantage of broadband frequency coverage. At microwave frequencies, however, an open rarely has perfect reflection characteristics because fringing (capacitance) effects cause phase shift that varies with frequency. These effects are impossible to eliminate, but the calibration kit models include the open termination capacitance at all frequencies for compatible calibration kits. The capacitance model is a cubic polynomial, as a function of frequency, where the polynomial coefficients are user-definable. The capacitance model equation is:

$$C = (C0) + (C1 * F) + (C2 * F^2) + (C3 * F^3)$$

where F is the measurement frequency.

The terms in the equation are defined with the specify open menu as follows:

**[C0]** (C0) is used to enter the C0 term, which is the constant term of the cubic polynomial and is scaled by  $10^{-15}$  Farads.

**[C1]** (C1) is used to enter the C1 term, expressed in F/Hz (Farads/Hz) and scaled by  $10^{-27}$ .

**[C2]** (C2) is used to enter the C2 term, expressed in F/Hz<sup>2</sup> and scaled by  $10^{-36}$ .

**[C3]** (C3) is used to enter the C3 term, expressed in F/Hz<sup>3</sup> and scaled by  $10^{-45}$ .

**[SHORT]** (STDTSHOR) defines the standard type as a short, for calibrating reflection measurements.

**[LOAD]** (STDTLOAD) defines the standard type as a load (termination). Loads are assigned a terminal impedance equal to the system characteristic impedance Z0, but delay and loss offsets may still be added. If the load impedance is not Z0, use the arbitrary impedance standard definition.

**[FIXED]** (FIXE) defines the load as a fixed (not sliding) load.

**[SLIDING]** (SLIL) defines the load as a sliding load. When such a load is measured during calibration, the analyzer will prompt for several load positions, and calculate the ideal load value from it.

**[DELAY/THRU]** (STDTDELA) defines the standard type as a transmission line of specified length, for calibrating transmission measurements.

**[ARBITRARY IMPEDANCE]** (STDTARBI) defines the standard type to be a load, but with an arbitrary impedance (different from system Z0).

**[TERMINAL IMPEDANCE]** (TERI) is used to specify the (arbitrary) impedance of the standard, in ohms.

**[FIXED]** (FIXE) defines the load as a fixed (not sliding) load.

**[SLIDING]** (SLIL) defines the load as a sliding load. When such a load is measured during calibration, the analyzer will prompt for several load positions, and calculate the ideal load value from it.

## Specify Offset Menu

The specify offset menu allows additional specifications for a user-defined standard. Features specified in this menu are common to all five types of standards.

Offsets may be specified with any standard type. This means defining a uniform length of transmission line to exist between the standard being defined and the actual measurement plane. (Example: a waveguide short termination, offset by a short length of waveguide.) For reflection standards, the offset is assumed to be between the measurement plane and the standard (one-way only). For transmission standards, the offset is assumed to exist between the two reference planes (in effect, the offset is the thru). Three characteristics of the offset can be defined: its delay (length), loss, and impedance.

In addition, the frequency range over which a particular standard is valid can be defined with a minimum and maximum frequency. This is particularly important for a waveguide standard, since its behavior changes rapidly beyond its cutoff frequency. Note that several band-limited standards can together be defined as the same "class" (see specify class menu). Then, if a measurement calibration is performed over a frequency range exceeding a single standard, additional standards can be used for each portion of the range.

Lastly, the standard must be defined as either coaxial or waveguide. If it is waveguide, dispersion effects are calculated automatically and included in the standard model.

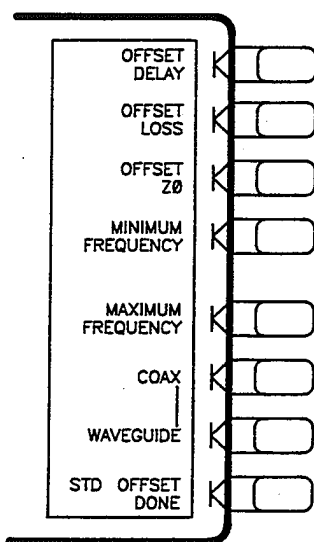

Figure 7-45. Specify Offset Menu

**[OFFSET DELAY]** (OFSD) is used to specify the one-way electrical delay from the measurement (reference) plane to the standard, in seconds (s). (In a transmission standard, offset delay is the delay from plane to plane.) Delay can be calculated from the precise physical length of the offset, the permittivity constant of the medium, and the speed of light.

In coax, group delay is considered constant. In waveguide, however, group delay is dispersive, that is, it changes significantly as a function of frequency. Hence, for a waveguide standard, offset delay must be defined at an infinitely high frequency.

**[OFFSET LOSS]** (OFSL) specifies energy loss, due to skin effect, along a one-way length of coax offset. The value of loss is entered as ohms/nanosecond (or Giga ohms/second) at 1 GHz. (Such losses are negligible in waveguide, so enter 0 as the loss offset.)

**[OFFSET Z0]** (OFSZ) specifies the characteristic impedance of the coax offset. (Note: This is *not* the impedance of the standard itself.) (For waveguide, the offset impedance is usually set to 1 for making normalized impedance measurements. When performing waveguide measurements, also make sure that the system's characteristic impedance is set to 1 (press **[CAL]** **[MORE]** **[SET Z0]** 1 **[x1]**).

**[MINIMUM FREQUENCY]** (MINF) defines the lowest frequency at which the standard can be used during measurement calibration. In waveguide, this *must* be the lower cutoff frequency of the standard, so that the analyzer can calculate dispersive effects correctly (see **[OFFSET DELAY]** above).

**[MAXIMUM FREQUENCY]** (MAXF) defines the highest frequency at which the standard can be used during measurement calibration. In waveguide, this is normally the upper cutoff frequency of the standard.

**[COAX]** (COAX) defines the standard (and the offset) as coaxial. This causes the analyzer to assume linear phase response in any offsets.

**[WAVEGUIDE]** (WAVE) defines the standard (and the offset) as rectangular waveguide. This causes the analyzer to assume a dispersive delay (see **[OFFSET DELAY]** above).

### Label Standard Menu (LABS)

This menu is used to label (reference) individual standards during the menu-driven measurement calibration sequence. The labels are user-definable using a character set displayed on the display that includes letters, numbers, and some symbols, and they may be up to ten characters long. The analyzer will prompt you to connect standards using these labels, so they should be meaningful to you, and distinct for each standard.

By convention, when sexed connector standards are labeled male (m) or female (f), the designation refers to the sex of the test port connector, not the sex of the standard.

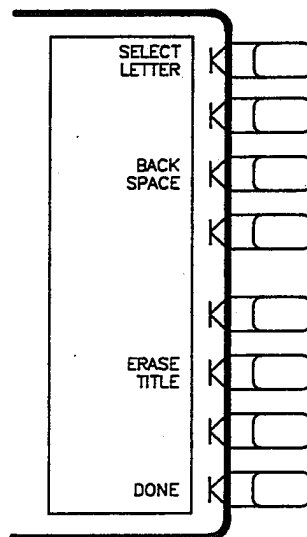

Figure 7-46. Label Standard Menu

Standard labels are created in the same way as titles. Refer to **[DISPLAY] Key, Title Menu** in Chapter 7.



## Specify Class Menus

Once a standard is specified, it must be assigned to a standard *class*. This is a group of from one to seven standards that is required to calibrate for a single error term. The standards within a single class are assigned to locations A through G as listed on the *Standard Class Assignments Table* (Table 7-5). A class often consists of a single standard, but may be composed of more than one standard if band-limited standards are used. (Example: All predefined calibration kits for the analyzer have a single load standard per class, since all are broadband in nature. However, if there were two load standards – a fixed load for low frequencies, and a sliding load for high frequencies – then that class would have two standards.)

Table 7-5. Standard Class Assignments Table

	A	B	C	D	E	F	G	STANDARD CLASS LABEL
S <sub>11</sub> A								
S <sub>11</sub> B								
S <sub>11</sub> C								
Forward Transmission								
Forward Match								
Response								
Response & Isolation								

The number of standard classes required depends on the type of calibration being performed, and is identical to the number of error terms corrected. (Examples: A response cal requires only one class, and the standards for that class may include an open and/or short and/or thru. A reflection 1-port cal requires three classes.)

The number of standards that can be assigned to a given class may vary from none (class not used) to one (simplest class) to seven. When a certain class of standards is required during calibration, the analyzer will display the labels for *all* the standards in that class (except when the class consists of a single standard). This does not, however, mean that all standards in a class must be measured during calibration. Unless band-limited standards are used, only a single standard per class is required. Note that it is often simpler to keep the number of standards per class to the minimum needed (often one) to avoid confusion during calibration.

Standards are assigned to a class simply by entering the standard's reference number (established while defining a standard) under a particular class.

Each class can be given a user-definable label as described under "Label Class Menu".

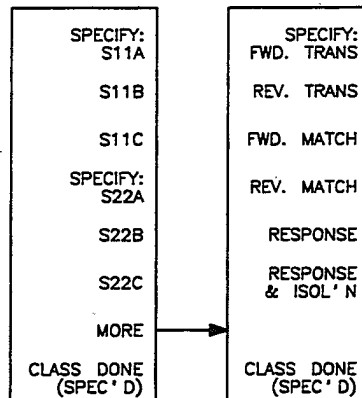

Figure 7-47. Specify Class Menus

**[SPECIFY: S11A]** (SPECS11A) is used to enter the standard number for the first class required for a reflection 1-port calibration. (For predefined cal kits, this is the open.)

**[S11B]** (SPECS11B) is used to enter the standard number for the second class required for a reflection 1-port calibration. (For predefined cal kits, this is the short.)

**[S11C]** (SPECS11C) is used to enter the standard number for the third class required for a reflection 1-port calibration. (For predefined kits, this is the load.)

**[SPECIFY: S22A]** is not used in the HP 8752.

**[S22B]** not used.

**[S22C]** not used.

**[MORE]** leads to the following softkeys.

**[FWD.TRANS.]** (SPECFWDT) is used to enter the standard number for the forward transmission thru calibration. (For predefined kits, this is the thru.)

**[REV.TRANS.]** not used.

**[FWD.MATCH]** not used.

**[REV.MATCH]** not used.

**[RESPONSE]** (SPECRESP) is used to enter the standard number for a response calibration. This calibration corrects for frequency response in either reflection or transmission measurements, depending on the parameter being measured when a calibration is performed. (For predefined kits, the standard is either the open or short for reflection measurements, or the thru for transmission measurements.)

**[RESPONSE & ISOL'N]** (SPECRESI) is used to enter the standard number for a response and isolation calibration. This calibration corrects for frequency response and directivity in reflection measurements, or frequency response and isolation in transmission measurements.

## Label Class Menus

The Label Class Menus define meaningful labels for the calibration classes. These become softkey labels during a measurement calibration. Labels can be up to ten characters long.

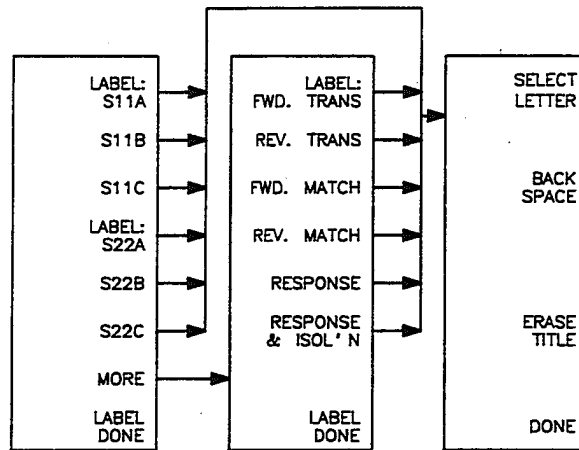

Figure 7-48. Label Class Menus

Labels are created in the same way as display titles. Refer to **[DISPLAY] Key, Title Menu** in Chapter 7.

## Label Kit Menu

After a new calibration kit has been defined, be sure to specify a label for it. Choose a label that describes the connector type of the calibration devices. This label will appear in the **[CAL KIT]** softkey label in the correction menu and the **[MODIFY]** label in the Select Cal Kit Menu. It will be saved with calibration data.

This menu is accessed with the **[LABEL KIT]** softkey in the Modify Cal Kit Menu, and is identical to the label class menu and the label standard menu described above. It allows definition of a label up to eight characters long.

## Verify Performance

Once a measurement calibration has been generated with a user-defined calibration kit, its performance should be checked before making device measurements. To check the accuracy that can be obtained using the new calibration kit, a device with a well-defined frequency response should be measured. The verification device should not be one of the calibration standards: measurement of one of these standards is merely a measure of repeatability.

To achieve more complete verification of a particular measurement calibration, accurately known verification standards with a diverse magnitude and phase response should be used. NIST\* traceable or HP standards are recommended to achieve verifiable measurement accuracy.

\* National Bureau of Science and Technology, formerly NBS (National Bureau of Standards).

## Example Procedure for Specifying a User-Defined Calibration Kit

The following procedure enters the HP 85033C 3.5 mm calibration kit values as a “user kit.” This is provided as an example to illustrate the steps required in defining a calibration kit model. These steps do include all related parameters (for example, offset Z0, minimum and maximum frequency, etc), and are intended to demonstrate the general process.

**NOTE:** Numerical data for most Hewlett-Packard calibration kits is provided in the calibration kit manuals.

1. The first keystroke sequence enters the values for standard #1, the short circuit.

- **[CAL] [CAL KIT] [MODIFY]**
- **[DEFINE STANDARD] [SHORT]**
- **[SPECIFY OFFSET] [OFFSET DELAY] [.] [0] [1] [6] [6] [9] [5] [G/n]**
- **[STD OFFSET DONE] [STD DONE (DEFINED)]**

2. The next sequence specifies standard #2, the open circuit.

- **[DEFINE STANDARD] [2] [x1] [OPEN]**
- **[C0] [5] [3] [x1]**
- **[C1] [1] [5] [0] [x1]**
- **[C2] [0] [x1]**
- **[C3] [0] [x1]**
- **[SPECIFY OFFSET] [OFFSET DELAY] [.] [0] [1] [4] [4] [9] [1] [G/n]**
- **[STD OFFSET DONE] [STD DONE (DEFINED)]**

3. The next sequence specifies standard #3, the lowband load.

- **[DEFINE STANDARD] [3] [x1] [LOAD]**
- **[SPECIFY OFFSET] [MAXIMUM FREQUENCY] [6] [.] [0] [0] [1] [G/n]**
- **[STD OFFSET DONE] [STD DONE (DEFINED)]**

4. The final sequence labels the kit and saves it in memory.

- **[LABEL KIT]**
- Use the knob and softkeys to modify the label to read “3.5mmC”
- **[DONE] [KIT DONE (MODIFIED)]**
  
- **[CAL]**
- **[CAL KIT 3.5mmC]**
- **[SAVE USER KIT] [USER KIT]**

The **[USER KIT]** softkey is now underlined, and the user-specified kit definition is saved in non-volatile memory.

## Appendix to Measurement Calibration

### ACCURACY ENHANCEMENT FUNDAMENTALS – CHARACTERIZING SYSTEMATIC ERRORS

#### Reflection Error Model

In a measurement of the reflection coefficient (magnitude and phase) of an unknown device, the measured data differs from the actual, no matter how carefully the measurement is made.

**Major sources of errors in reflection measurements.** Directivity, source match, and reflection tracking are the major sources of error (Figure 7-49).

**NOTE:** This appendix uses scatter-parameter (S-parameter) terminology. S11 represents the signal that reflects from the input of the DUT. S21 represents the signal that is transmitted through the DUT.

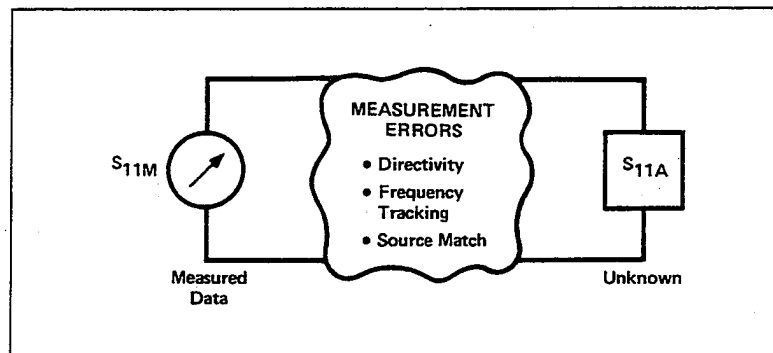

Figure 7-49. Sources of Error in a Reflection Measurement

**Measuring reflection coefficient.** The reflection coefficient is measured by first separating the incident signal (I) from the reflected signal (R), then taking the ratio of the two values (Figure 7-50). Ideally, (R) consists only of the signal reflected by the test device (S11A).

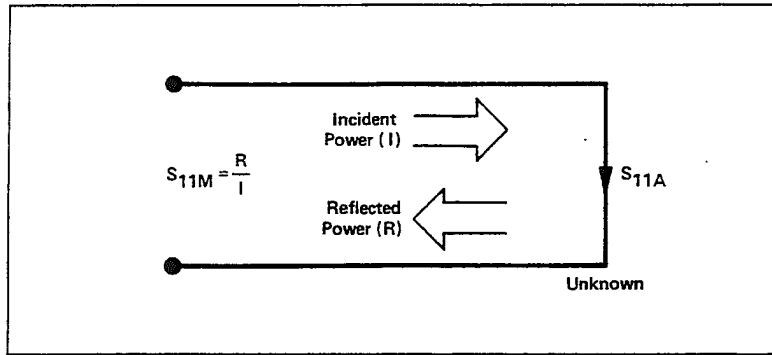

Figure 7-50. Reflection Coefficient

**Directivity error.** However, all of the incident signal does not always reach the unknown (see Figure 7-51). Some of (I) may appear at the measurement system input due to leakage through the test set or other signal separation device. Also, some of (I) may be reflected by imperfect adapters between signal separation and the measurement plane. The vector sum of the leakage and miscellaneous reflections is directivity, EDF. Understandably, the measurement is distorted when the directivity signal combines vectorally with the actual reflected signal from the unknown,  $S_{11A}$ .

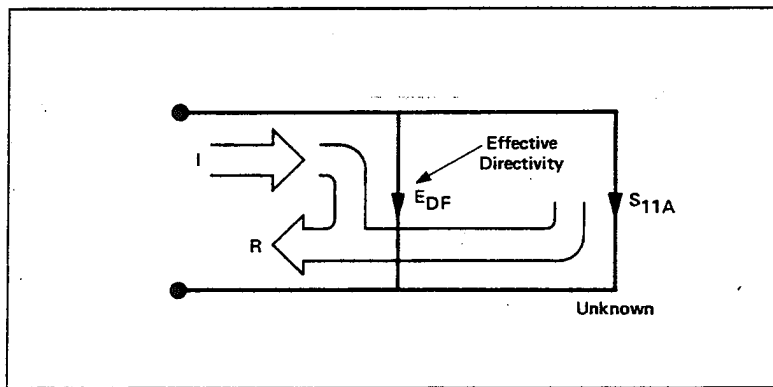

Figure 7-51. Effective Directivity EDF

**Source match error.** Since the measurement system test port is never exactly the characteristic impedance, some of the reflected signal is re-reflected off the test port, or other impedance transitions further down the line, and back to the unknown, adding to the original incident signal (I). This effect causes the magnitude and phase of the incident signal to vary as a function of  $S_{11A}$  and frequency. This re-reflection effect and the resultant incident power variation are modeled by the source match error term, ESF (Figure 7-52).

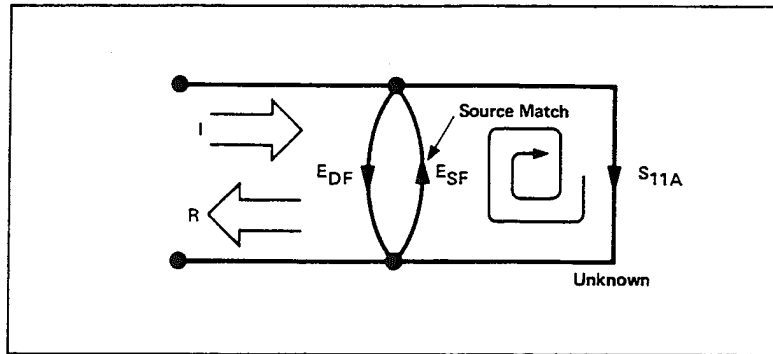

Figure 7-52. Source Match ESF

**Reflection tracking error.** Reflection tracking error is caused by variations in magnitude and phase between the test and reference signal paths. These are due mainly to imperfectly matched samplers and differences in length and loss between incident and test signal paths. The vector sum of these variations is modeled by the reflection tracking error, E<sub>RF</sub> (Figure 7-53).

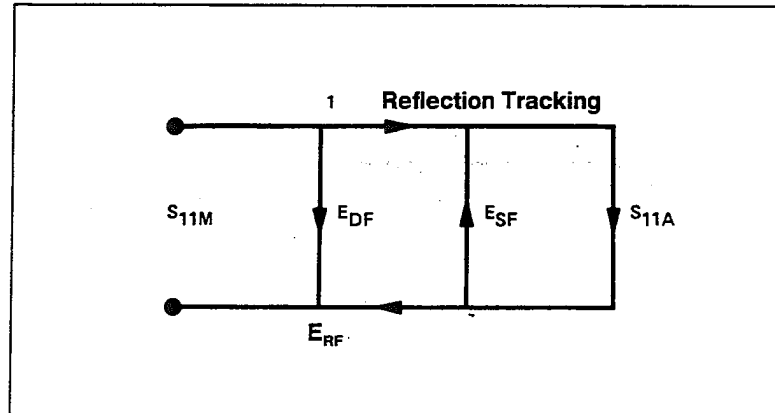

Figure 7-53. Reflection Tracking ERF

**How calibration standards are used to quantify these error terms.** It can be shown that these three errors are mathematically related to the actual data, S<sub>11A</sub>, and measured data, S<sub>11M</sub>, by the following equation:

$$S_{11M} = E_{DF} + \frac{S_{11A} (E_{RF})}{1 - E_{SF} S_{11A}}$$

If the value of these three “E” error terms and the measured test device response were known for each frequency, the above equation could be solved for S<sub>11A</sub> to obtain the actual test device response. Because each of these errors changes with frequency, it is necessary that their values be known at each test frequency. These values are found by measuring the system at the measurement plane using three independent standards whose S<sub>11A</sub> is known at all frequencies.

The first standard applied is a "perfect load", which makes  $S_{11A} = 0$  and essentially measures directivity (Figure 7-54). "Perfect load" implies a reflectionless termination at the measurement plane. All incident energy is absorbed. With  $S_{11A} = 0$  the equation can be solved for EDF, the directivity term. In practice, of course, the "perfect load" is difficult to achieve, although very good broadband loads are available in compatible calibration kits.

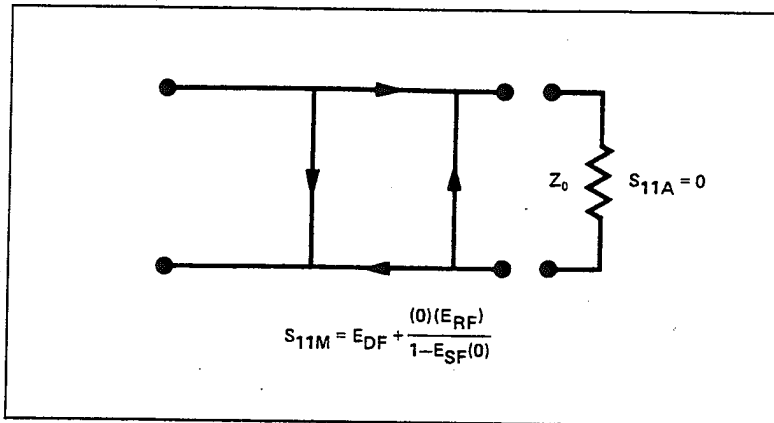

Figure 7-54. "Perfect Load" Termination

Since the measured value for directivity is the vector sum of the actual directivity plus the actual reflection coefficient of the "perfect load," any reflection from the termination represents an error. System effective directivity becomes the actual reflection coefficient of the "perfect load" (Figure 7-55). In general, any termination having a reflection coefficient smaller than the uncorrected system directivity reduces reflection measurement uncertainty.

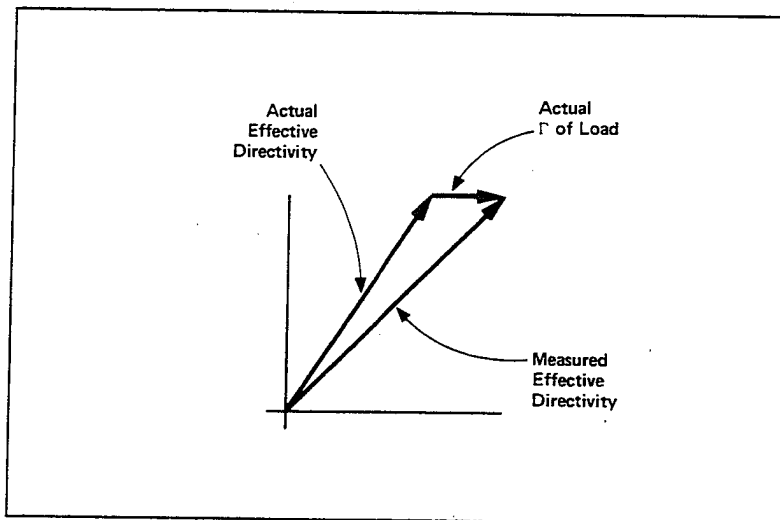

Figure 7-55. Measured Effective Directivity

Next, a short termination whose response is known to a very high degree is used to establish another condition (Figure 7-56).



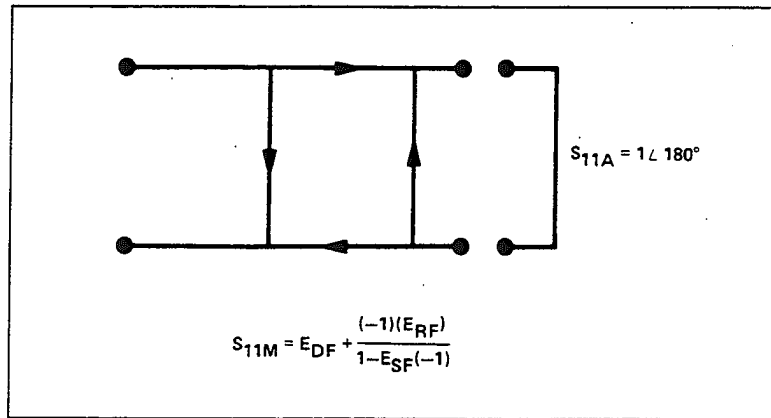

Figure 7-56. Short Termination

The open termination gives the third independent condition. In order to accurately model the phase variation with frequency (caused by radiation from the open terminator), a shielded open is used in this step. (the open circuit capacitance is different with each connector type). Now the values for EDF, directivity, ESF, source match, and ERF, reflection frequency response, are computed and stored (Figure 7-57).

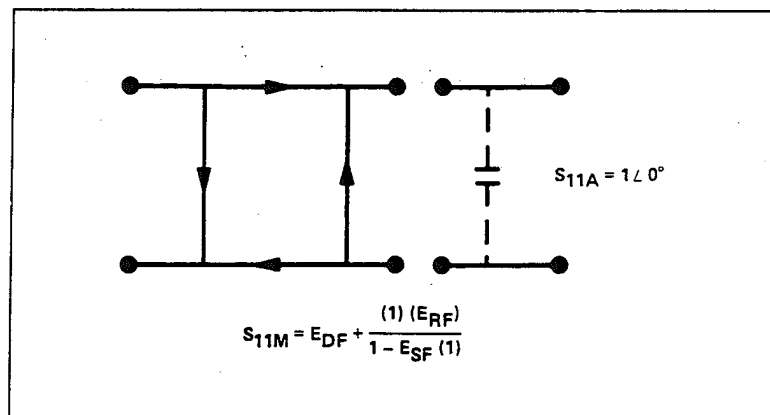

Figure 7-57. Open Termination

Now the unknown is measured to obtain a value for the measured response,  $S_{11M}$ , at each frequency (Figure 7-58).

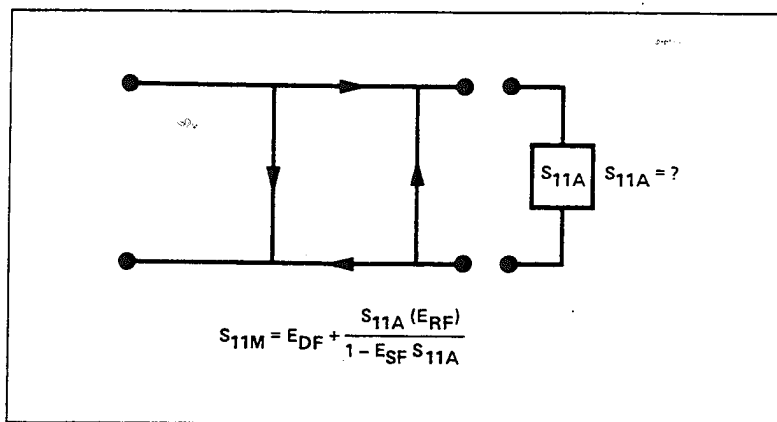

Figure 7-58. Measured  $S_{11}$

This is the one-port error model equation solved for  $S_{11A}$ . Since the three errors and  $S_{11M}$  are now known for each test frequency,  $S_{11A}$  can be computed as follows:

$$S_{11A} = \frac{S_{11M} - E_{DF}}{E_{SF}(S_{11M} - E_{DF}) + E_{RF}}$$

For reflection measurements on two-port devices, the same technique can be applied, but the test device output port must be terminated in the system characteristic impedance. This termination should be at least as good (have as low a reflection coefficient) as the load used to determine directivity. The additional reflection error caused by an improper termination at the test device output port is not incorporated into the reflection error model.

### Transmission Error Model

The error model for measurement of the transmission coefficients (magnitude and phase) of a two-port device is derived in a similar manner.

**Major sources of transmission errors.** The major sources of error are transmission tracking, source match, isolation, and load match (Figure 5-42).

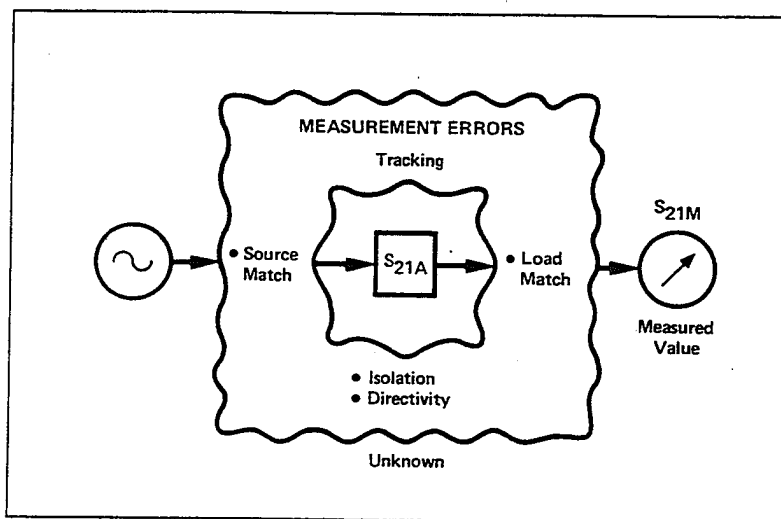

Figure 7-59. Major Sources of Transmission Errors

**Measuring Transmission Coefficient.** The transmission coefficient is measured by taking the ratio of the incident signal (I) and the transmitted signal (T) (Figure 7-60). Ideally, (I) consists only of power delivered by the source, and (T) consists only of power emerging at the test device output.

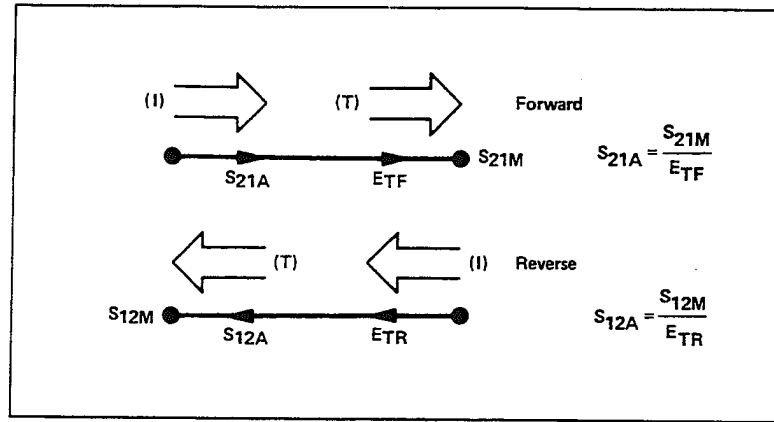

Figure 7-60. Transmission Coefficient

**Transmission tracking error.** Transmission tracking error is caused by variations in magnitude and phase flatness versus frequency between the test and reference signal paths. This is discussed in “Reflection Tracking” and “Transmission Tracking and Reflection Tracking”, earlier in this section. This error term is quantified by connecting a thru connection between the test ports and measuring the system’s transmission frequency response. The data is corrected for source effects, then is stored as transmission tracking, ETF. Residual transmission tracking errors come from mismatch uncertainties when connecting the thru.

**Isolation Errors.** Isolation, EXF, represents the part of the incident signal that appears at the receiver without actually passing through the test device (Figure 7-61). Isolation is measured with the test set in the transmission configuration and with terminations installed at the points where the test device will be connected.

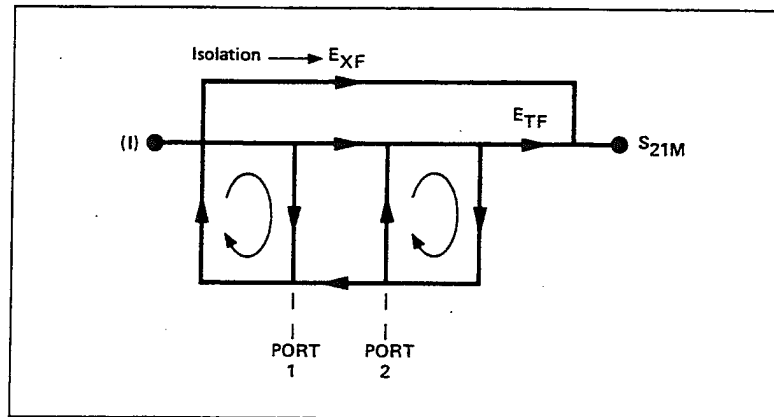

Figure 7-61. Isolation EXF

## **Error Terms the Analyzer Can Reduce**

The analyzer can reduce the following error terms.

- Reflection:
  - Directivity, EDF
  - Reflection tracking, ERF
  - Source Match, ESF
- Transmission:
  - Transmission tracking, ETF
  - Isolation, EXF

# MKR and MKR FCTN MENU MAPS

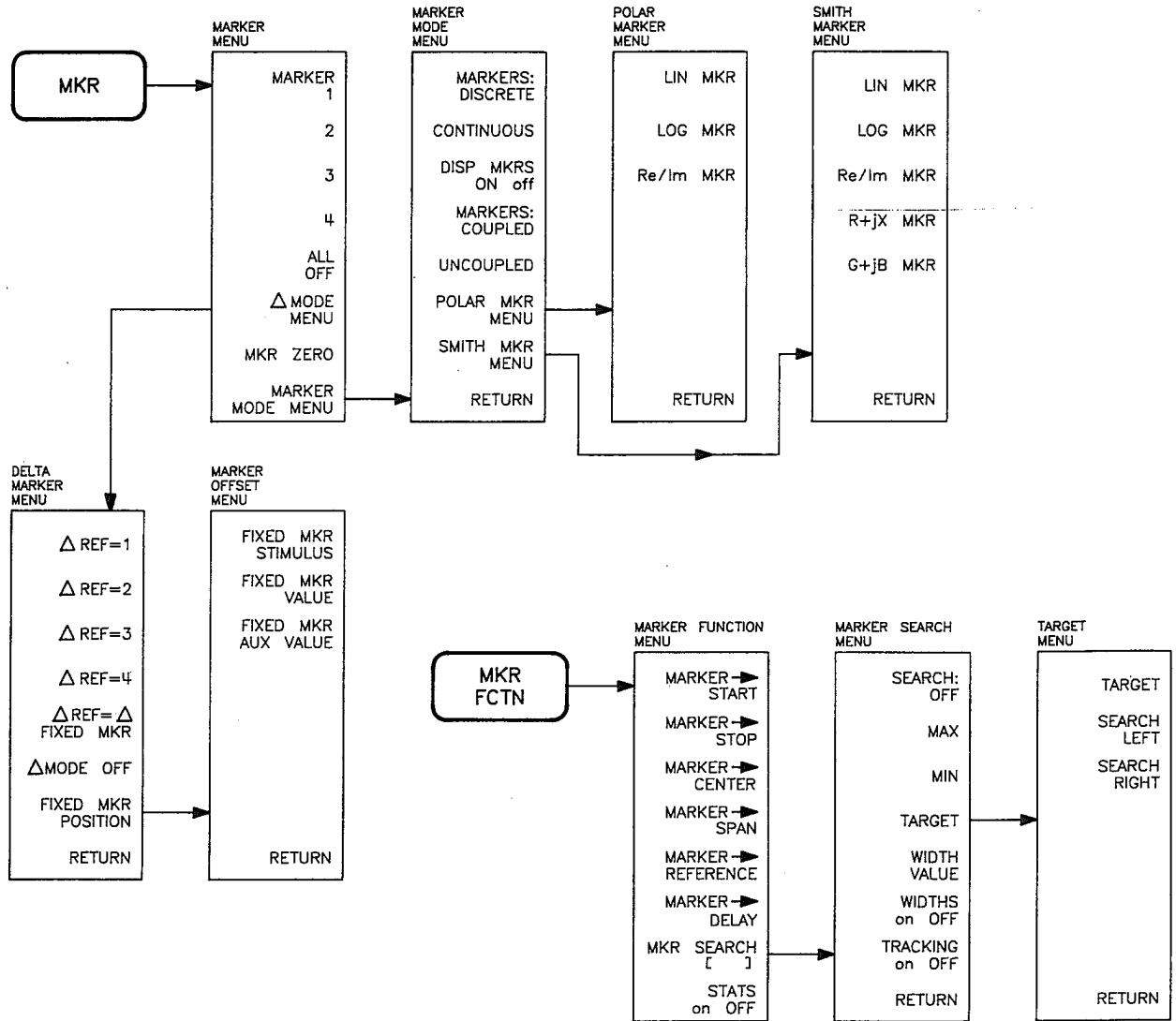

Refer to this foldout menu map as needed when using this tab section.

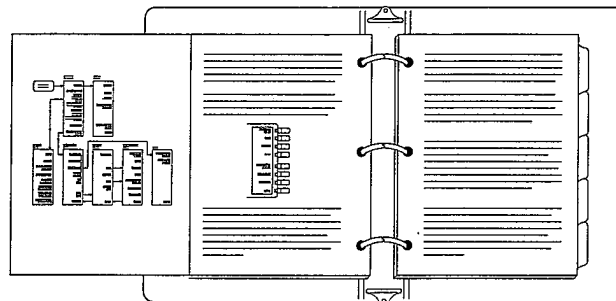

Figure 7-62. Menus Accessed by MKR and MKR FCTN Keys

# Using Markers

## CONTENTS

- 7-75 [MKR] Key
- 7-77 Marker Menu
- 7-78 Delta Marker Mode Menu
- 7-79 Fixed Marker Menu
- 7-81 Marker Mode Menu
- 7-82 Polar Marker Menu
- 7-83 Smith Marker Menu
- 7-84 [MKR FCTN] Key
- 7-84 Marker Function Menu
- 7-86 Marker Search Menu
- 7-88 Target Menu

## [MKR] KEY

The HP-IB programming command is shown in parenthesis following the key or softkey.

The [MKR] (MENUMARK) key displays a movable active marker ( $\nabla$ ) on the screen and provides access to a series of menus to control one to four display markers for each channel (a total of eight). Markers are used to obtain numerical readings of measured values. They also provide capabilities for reducing measurement time by changing stimulus parameters, searching the trace for specific values, or statistically analyzing part or all of the trace. Figure 7-63 illustrates the displayed trace with all markers on and marker 1 the active marker.

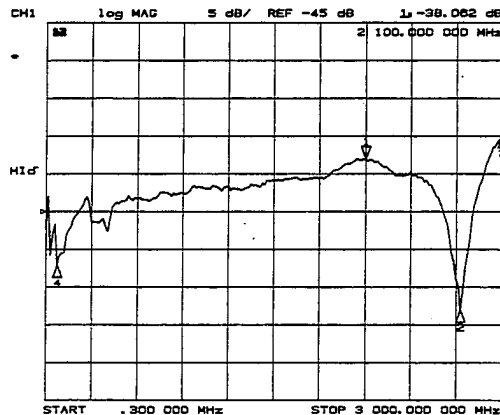

Figure 7-63. Markers on Trace

Markers have a stimulus value (the x-axis value in a Cartesian format) and a response value (the y-axis value in a Cartesian format). In a polar or Smith chart format, the second part of a complex data pair is also provided as an auxiliary response value. When a marker is turned on and no other function is active, its stimulus value is displayed in the active entry area and can be controlled with the knob, the step keys, or the numeric keypad. The active marker can be moved to any point on the trace, and its response and stimulus values are displayed at the top right corner of the graticule for each displayed channel, in units appropriate to the display format. The displayed marker response values are valid even when the measured data is above or below the range displayed on the graticule.

Marker values are normally continuous: that is, they are interpolated between measured points. Alternatively, they can be set to read only discrete measured points. The markers for the two channels normally have the same stimulus values, or they can be uncoupled so that each channel has independent markers, regardless of whether stimulus values are coupled or dual channel display is on.

If both data and memory are displayed, the marker values apply to the data trace. If memory only is displayed, the marker values apply to the memory trace. In a memory math display (data/memory or data-memory), the marker values apply to the trace resulting from the memory math function.

With the use of a reference marker, a delta marker mode is available that displays both the stimulus and response values of the active marker relative to the reference. Any of the four markers or a fixed point can be designated as the delta reference marker. If the delta reference is one of the four markers, its stimulus value can be controlled by the user and its response value is the value of the trace at that stimulus value. If the delta reference is a fixed marker, both its stimulus value and its response value can be set arbitrarily by the user anywhere in the display area (not necessarily on the trace).

Markers can be used to search for the trace maximum or minimum point or any other point on the trace. The four markers can be used together to search for specified bandwidth cutoff points and calculate the bandwidth and Q values. In addition, insertion loss is displayed for the frequency point indicated by Marker 1. Statistical analysis uses markers to provide a readout of the mean, standard deviation, and peak-to-peak values of all or part of the trace.

Basic marker operations are available in the menus accessed from the **[MKR]** key. The marker search and statistical functions, together with the capability for quickly changing stimulus parameters with markers, are provided in the menus accessed from the **[MKR FCTN]** key.

The menus accessed from the **[MKR]** key (Figure 7-62) provide several basic marker operations. These include different marker modes for different display formats, and the delta marker mode that displays marker values relative to a specified value.

## Marker Menu

The marker menu (Figure 7-64) turns the display markers on or off, to designate the active marker, and to gain access to the marker delta mode and other marker modes and formats.

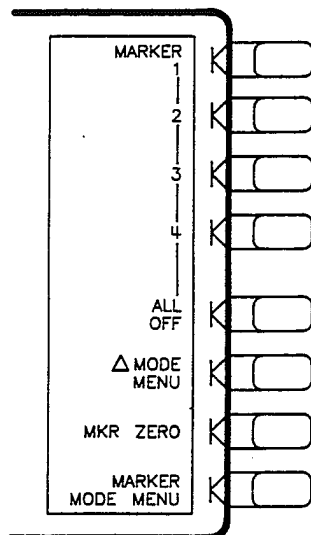

Figure 7-64. Marker Menu

**[MARKER 1]** (MARK1) turns on marker 1 and makes it the active marker. The active marker appears on the display as ▽. The active marker stimulus value is displayed in the active entry area, together with the marker number. If there is a marker turned on, and no other function is active, the stimulus value of the active marker can be controlled with the knob, the step keys, or the numeric keypad. The marker response and stimulus values are displayed in the upper right-hand corner of the screen.

**[MARKER 2]** (MARK2) turns on marker 2 and makes it the active marker. If another marker is present, that marker becomes inactive and is represented on the display as Δ.

**[MARKER 3]** (MARK3) turns on marker 3 and makes it the active marker.

**[MARKER 4]** (MARK4) turns on marker 4 and makes it the active marker.

**[ALL OFF]** (MARKOFF) turns off all the markers and the delta reference marker, as well as the tracking and bandwidth functions that are accessed with the **[MKR FCTN]** key.

**[Δ MODE MENU]** goes to the delta marker menu, which is used to read the difference in values between the active marker and a reference marker.

**[MKR ZERO]** (MARKZERO) puts a fixed reference marker at the present active marker position, and makes the fixed marker stimulus and response values at that position equal to zero. All subsequent stimulus and response values of the active marker are then read out relative to the fixed marker. The fixed marker is shown on the display as a small triangle Δ (delta), smaller than the inactive marker triangles. The softkey label changes from **[MKR ZERO]** to **[MKR ZERO Δ REF = Δ]** and the notation "ΔREF=Δ" is displayed at the top right corner of the graticule. Marker zero is canceled by turning delta mode off in the delta marker menu or turning all the markers off with the **[ALL OFF]** softkey.

**[MARKER MODE MENU]** provides access to the marker mode menu, where several marker modes can be selected including special markers for polar and Smith chart formats.



## Delta Marker Mode Menu

The delta marker mode reads the difference in stimulus and response values between the active marker and a designated delta reference marker. Any of the four markers or a fixed point can be designated as the reference marker. If the reference is one of the four markers, its stimulus value can be controlled by the user and its response value is the value of the trace at that stimulus value. If the reference is a fixed marker, both its stimulus value and its response value can be set arbitrarily by the user anywhere in the display area. The delta reference is shown on the display as a small triangle  $\Delta$  (delta), smaller than the inactive marker triangles. If one of the markers is the reference, the triangle appears next to the marker number on the trace.

The marker values displayed in this mode are the stimulus and response values of the active marker minus the reference marker. If the active marker is also designated as the reference marker, the marker values are zero.

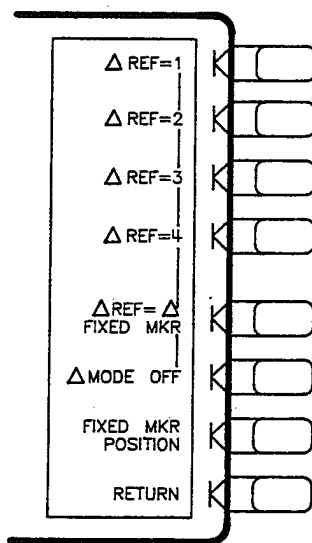

Figure 7-65. Delta Marker Mode Menu

[  $\Delta$  REF = 1 ] (DELR1) establishes marker 1 as a reference. The active marker stimulus and response values are then shown relative to this delta reference. Once marker 1 has been selected as the delta reference, the softkey label [  $\Delta$  REF = 1 ] is underlined in this menu, and the marker menu is returned to the screen. In the marker menu, the first key is now labeled [ **MARKER  $\Delta$  REF = 1** ]. The notation " $\Delta$ REF=1" appears at the top right corner of the graticule.

[  $\Delta$  REF = 2 ] (DELR2) makes marker 2 the delta reference. Active marker stimulus and response values are then shown relative to this reference.

[  $\Delta$  REF = 3 ] (DELR3) makes marker 3 the delta reference.

[  $\Delta$  REF = 4 ] (DELR4) makes marker 4 the delta reference.

**[ $\Delta$  REF =  $\Delta$  FIXED MKR]** (DELRFIXM) sets a user-specified fixed reference marker. The stimulus and response values of the reference can be set arbitrarily, and can be anywhere in the display area. Unlike markers 1 to 4, the fixed marker need not be on the trace. The fixed marker is indicated by a small triangle  $\Delta$ , and the active marker stimulus and response values are shown relative to this point. The notation " $\Delta$ REF= $\Delta$ " is displayed at the top right corner of the graticule.

Pressing this softkey turns on the fixed marker. Its stimulus and response values can then be changed using the fixed marker menu, which is accessed with the **[FIXED MKR POSITION]** softkey described below. Alternatively, the fixed marker can be set to the current active marker position, using the **[MKR ZERO]** softkey in the marker menu.

**[ $\Delta$  MODE OFF]** (DELO) turns off the delta marker mode, so that the values displayed for the active marker are absolute values.

**[FIXED MKR POSITION]** leads to the fixed marker menu, where the stimulus and response values for a fixed reference marker can be set arbitrarily.

Alternatively, the current position of the active marker can be entered as the fixed reference by using **[MARKER ZERO]** in the marker menu.

**[RETURN]** goes back to the marker menu.

## Fixed Marker Menu

This menu sets the position of a fixed reference marker, indicated on the display by a small triangle  $\Delta$ . Both the stimulus value and the response value of the fixed marker can be set arbitrarily anywhere in the display area, and need not be on the trace. The units are determined by the display format, the sweep type, and the marker type.

There are two ways to turn on the fixed marker. One way is with the **[ $\Delta$  REF =  $\Delta$  FIXED MKR]** softkey in the delta marker menu. The other is with the **[MKR ZERO]** function in the marker menu, which puts a fixed reference marker at the present active marker position and makes the marker stimulus and response values at that position equal to zero.

The softkeys in this menu make the values of the fixed marker the active function. The marker readings in the top right corner of the graticule are the stimulus and response values of the active marker minus the fixed reference marker. Also displayed in the top right corner is the notation " $\Delta$ REF= $\Delta$ ."

The stimulus value, response value, and auxiliary response value (the second part of a complex data pair) can be individually examined and changed. This allows active marker readings that are relative in amplitude yet absolute in frequency, or any combination of relative/absolute readouts. Following a **[MKR ZERO]** operation, this menu can be used to reset any of the fixed marker values to absolute zero for absolute readings of the subsequent active marker values.

If the format is changed while a fixed marker is on, the fixed marker values become invalid. For example, if the value offset is set to 10 dB with a log magnitude format, and the format is then changed to phase, the value offset becomes 10 degrees. However, in polar and Smith chart formats, the specified values remain consistent between different marker types for those formats. Thus an R+jX marker set on a Smith chart format will retain the equivalent values if it is changed to any of the other Smith chart markers.

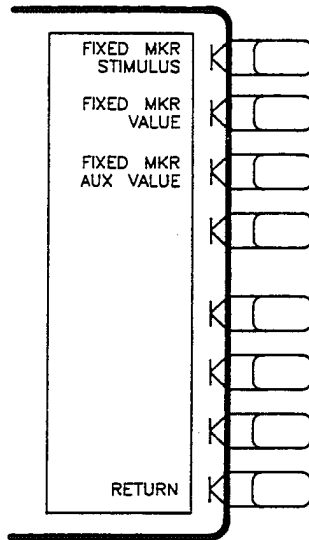

Figure 7-66. The Fixed Marker Menu

**[FIXED MKR STIMULUS]**(MARKFSTI) changes the stimulus value of the fixed marker. Fixed marker stimulus values can be different for the two channels if the channel markers are uncoupled using the marker mode menu.

To read absolute active marker stimulus values following a **[MKR ZERO]** operation, the stimulus value can be reset to zero.

**[FIXED MKR VALUE]** (MARKFVAL) changes the response value of the fixed marker. In a Cartesian format this is the y-axis value. In a polar or Smith chart format with a magnitude/phase marker, a real/imaginary marker, an  $R + jX$  marker, or a  $G + jB$  marker, this applies to the first part of the complex data pair. Fixed marker response values are always uncoupled in the two channels.

To read absolute active marker response values following a **[MKR ZERO]** operation, the response value can be reset to zero.

**[FIXED MKR AUX VALUE]** (MARKFAUV) is used only with a polar or Smith format. It changes the auxiliary response value of the fixed marker. This is the second part of a complex data pair, and applies to a magnitude/phase marker, a real/imaginary marker, an  $R + jX$  marker, or a  $G + jB$  marker. Fixed marker auxiliary response values are always uncoupled in the two channels.

To read absolute active marker auxiliary response values following a **[MKR ZERO]** operation, the auxiliary value can be reset to zero.

**[RETURN]** goes back to the delta marker menu.

## Marker Mode Menu

This menu provides different marker modes and makes available two additional menus of special markers for use with Smith chart or polar formats.

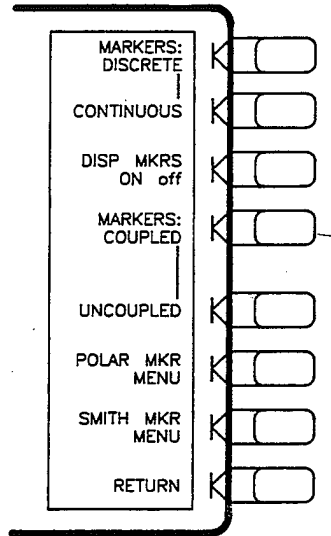

Figure 7-67. Marker Mode Menu

**[MARKERS: DISCRETE]** (MARKDISC) places markers only on measured trace points determined by the stimulus settings.

**[CONTINUOUS]** (MARKCONT) interpolates between measured points to allow the markers to be placed at any point on the trace. Displayed marker values are also interpolated. This is the default marker mode.

**[DISP MKRS ON off]** (DISM) displays response and stimulus values for all markers that are turned on. Available only if no marker functions (marker stats or widths) are on.

**[MARKERS: COUPLED]** (MARKCOUP) couples the marker stimulus values for the two display channels. Even if the stimulus is uncoupled and two sets of stimulus values are shown, the markers track the same stimulus values on each channel as long as they are within the displayed stimulus range.

**[UNCOUPLED]** (MARKUNCO) allows the marker stimulus values to be controlled independently on each channel.

**[POLAR MKR MENU]** leads to a menu of special markers for use with a polar format.

**[SMITH MKR MENU]** leads to a menu of special markers for use with a Smith chart format.

**[RETURN]** goes back to the marker menu.

## Polar Marker Menu

This menu is used only with a polar display format, selectable using the **[FORMAT]** key. In a polar format, the magnitude at the center of the circle is zero and the outer circle is the full scale value set in the scale reference menu. Phase is measured as the angle counterclockwise from 0° at the positive x-axis. The analyzer automatically calculates different mathematical forms of the marker magnitude and phase values, selected using the softkeys in this menu. Marker frequency is displayed in addition to other values regardless of the selection of marker type.

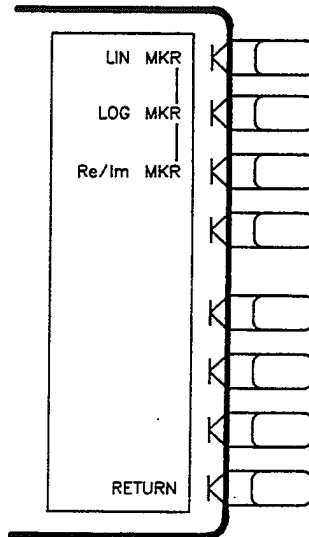

Figure 7-68. Polar Marker Menu

**[LIN MKR]** (POLMLIN) displays a readout of the linear magnitude and the phase of the active marker. This is the preset marker type for a polar display. Magnitude values are read in units and phase in degrees.

**[LOG MKR]** (POLMLOG) displays the logarithmic magnitude and the phase of the active marker. Magnitude values are expressed in dB and phase in degrees. This is useful as a fast method of obtaining a reading of the log magnitude value without changing to log magnitude format.

**[Re/Im MKR]** (POLMRI) displays the values of the active marker as a real and imaginary pair. The complex data is separated into its real part and imaginary part. The first marker value given is the real part  $M \cos \theta$ , and the second value is the imaginary part  $M \sin \theta$ , where  $M$  = magnitude.

**[RETURN]** goes back to the marker mode menu.

## Smith Marker Menu

This menu is used only with a Smith chart format, selected from the format menu. The analyzer automatically calculates different mathematical forms of the marker magnitude and phase values, selected using the softkeys in this menu. Marker frequency is displayed in addition to other values for all marker types.

For additional information about the Smith chart display format, refer to “[FORMAT] Key” in Chapter 7.

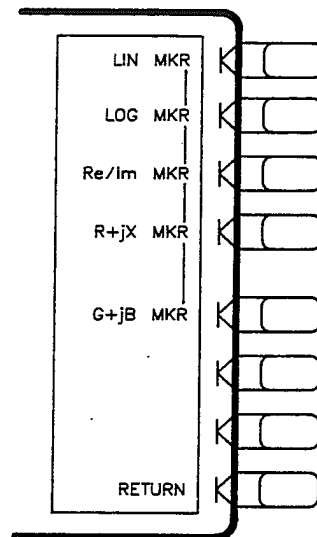

Figure 7-69. Smith Marker Menu

**[LIN MKR]** (SMIMLIN) displays a readout of the linear magnitude and the phase of the active marker. Marker magnitude values are expressed in units and phase in degrees.

**[LOG MKR]** (SMIMLOG) displays the logarithmic magnitude value and the phase of the active marker. Magnitude values are expressed in dB and phase in degrees. This is useful as a fast method of obtaining a reading of the log magnitude value without changing to log magnitude format.

**[Re/Im MKR]** (SMIMRI) displays the values of the active marker on a Smith chart as a real and imaginary pair. The complex data is separated into its real part and imaginary part. The first marker value given is the real part  $M \cos \theta$ , and the second value is the imaginary part  $M \sin \theta$ , where  $M$  = magnitude.

**[R+jX MKR]** (SMIMRX) converts the active marker values into rectangular form. The complex impedance values of the active marker are displayed in terms of resistance, reactance, and equivalent capacitance or inductance. This is the default Smith chart marker.

The normalized impedance  $Z_0$  for characteristic impedances other than 50 ohms (for HP 8752A) or 75 ohms (for HP 8752B) can be selected in the calibrate more menu.

**[G+jB MKR]** (SMIMGB) displays the complex admittance values of the active marker in rectangular form. The active marker values are displayed in terms of conductance (in Siemens), susceptance, and equivalent capacitance or inductance. Siemens are the international units of admittance, and are equivalent to mhos (the inverse of ohms).

**[RETURN]** goes back to the marker mode menu.

## [MKR FCTN] KEY

The HP-IB programming command is shown in parenthesis following the key or softkey.

The [MKR FCTN] (MENUMRKF) key activates a marker if one is not already active, and provides access to additional marker functions. These can be used to quickly change the measurement parameters, to search the trace for specified information, and to analyze the trace statistically.

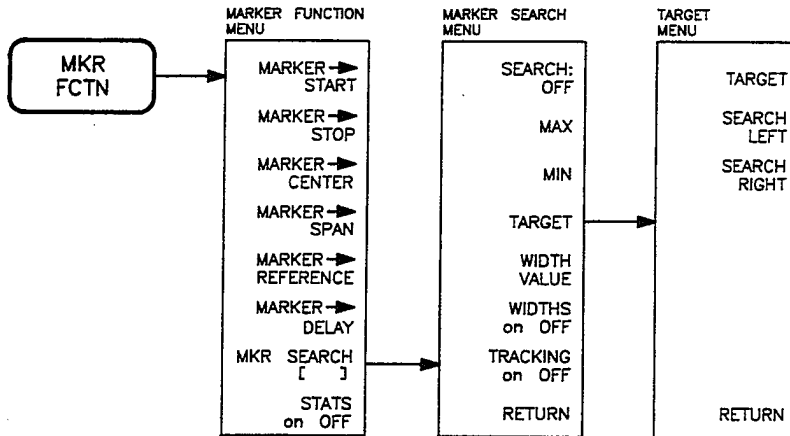

Figure 7-70. Menus Accessed from the [MKR FCTN] Key

## Marker Function Menu

This menu provides softkeys that use markers to quickly modify certain measurement parameters without going through the usual key sequence. In addition, it provides access to two additional menus used for searching the trace and for statistical analysis.

The [MARKER →] functions change certain stimulus and response parameters to make them equal to the current active marker value. Use the knob or the numeric keypad to move the marker to the desired position on the trace, and press the appropriate softkey to set the specified parameter to that trace value. When the values have been changed, the marker can again be moved within the range of the new parameters.

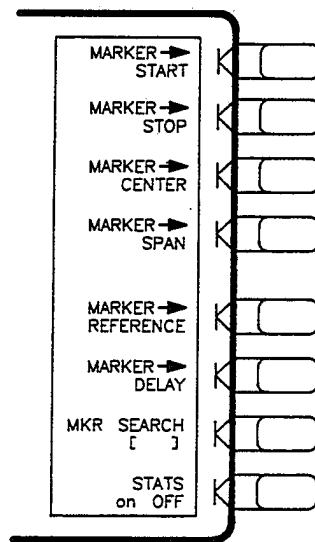

Figure 7-71. Marker Function Menu

**[MARKER → START]** (MARKSTAR) changes the stimulus start value to the stimulus value of the active marker.

**[MARKER → STOP]** (MARKSTOP) changes the stimulus stop value to the stimulus value of the active marker.

**[MARKER → CENTER]** (MARKCENT) changes the stimulus center value to the stimulus value of the active marker, and centers the new span about that value.

**[MARKER → SPAN]** (MARKSPAN) changes the start and stop values of the stimulus span to the values of the active marker and the delta reference marker. If there is no reference marker, the message "NO MARKER DELTA – SPAN NOT SET" is displayed.

**[MARKER → REFERENCE]** (MARKREF) makes the reference value equal to the active marker's response value, without changing the reference position. In a polar or Smith chart format, the full scale value at the outer circle is changed to the active marker response value. This softkey also appears in the Scale Reference Menu.

**[MARKER → DELAY]** (MARKDELA) adjusts the electrical delay to balance the phase of the DUT. This is performed automatically, regardless of the format and the measurement being made. Enough line length is added to or subtracted from the receiver input to compensate for the phase slope at the active marker position. This effectively flattens the phase trace around the active marker, and can be used to measure electrical length or deviation from linear phase. Additional electrical delay adjustments are required on DUTs without constant group delay over the measured frequency span. Since this feature adds phase to a variation in phase versus frequency, it is applicable only for ratioed inputs. This softkey also appears in the scale reference menu.

**NOTE:** A new marker function, **[MARKER → CW]**, is available in the test sequence function softkey menus. This feature is intended for use in automated compression measurements. Test sequences allow the instrument to automatically find a maximum or minimum point on a response trace. The **[MARKER → CW]** command sets the instrument to the CW frequency of the active marker. When power sweep is engaged, the CW frequency will already be selected.

**[MARKER SEARCH]** leads to the marker search menu, which is used to search the trace for a particular value or bandwidth.

**[STATS on OFF]** (MEASTATON, MEASTATOFF) calculates and displays the mean, standard deviation, and peak-to-peak values of the section of the displayed trace between the active marker and the delta reference marker. If there is no delta reference, the statistics are calculated for the entire trace. A convenient use of this feature is to find the peak-to-peak value of passband ripple without searching separately for the maximum and minimum values.

The statistics are absolute values: the delta marker here serves to define the span. For polar and Smith chart formats the statistics are calculated using the first value of the complex pair (magnitude, real part, resistance, or conductance).



## Marker Search Menu

This menu is used to search the trace for a specific amplitude-related point, and place the marker on that point. The capability of searching for a specified bandwidth is also provided. Tracking is available for a continuous sweep-to-sweep search. If there is no occurrence of a specified value or bandwidth, the message "TARGET VALUE NOT FOUND" is displayed.

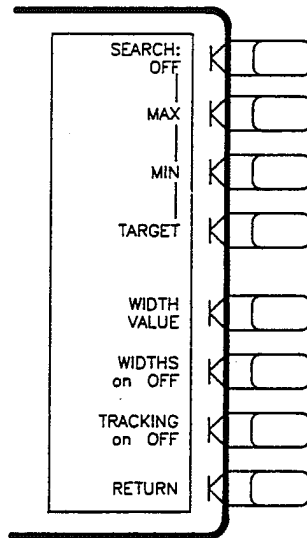

Figure 7-72. Marker Search Menu

**[SEARCH: OFF]** (SEAOFF) turns off the marker search function.

**[MAX]** (SEAMAX) moves the active marker to the maximum point on the trace.

**[MIN]** (SEAMIN) moves the active marker to the minimum point on the trace.

**[TARGET]** (SEATARG) makes target value the active function, and places the active marker at a specified target point on the trace. The default target value is  $-3$  dB. The target menu is presented, providing search right and search left options to resolve multiple solutions.

For relative measurements, a search reference must be defined with a delta marker or a fixed marker before the search is activated.

**[WIDTH VALUE]** (WIDV) is used to set the amplitude parameter (for example  $-3$  dB) that defines the start and stop points for a bandwidth search. The bandwidth search feature analyzes a bandpass or band reject trace and calculates the center point, bandwidth, and Q (quality factor) for the specified bandwidth. Bandwidth units are the units of the current format. Insertion loss is shown on the display as well. The value shown is the insertion loss at Marker 1.

**[WIDTHS on OFF]** (WIDTON, WIDTOFF) turns on the bandwidth search feature explained under "**[WIDTH VALUE]**", above.

All four markers are turned on, and each has a dedicated use. Marker 1 is a starting point from which the search is begun. Marker 2 goes to the bandwidth center point. Marker 3 goes to the bandwidth cutoff point on the left, and marker 4 to the cutoff point on the right.

If a delta marker or fixed marker is on, it becomes the reference point from which the bandwidth amplitude is measured. For example, if marker 1 is the delta marker and is set at the passband maximum, and the width value is set to  $-3$  dB, the bandwidth search finds the bandwidth cutoff points 3 dB below the maximum and calculates the 3 dB bandwidth, Q, and insertion loss.

If marker 2 (the dedicated bandwidth center point marker) is the delta reference marker, the search finds the points 3 dB down from the center.

If no delta reference marker is set, the bandwidth values are absolute values.

**[TRACKING on OFF]** (TRACKON, TRACKOFF) is used in conjunction with other search features to track the search with each new sweep. Turning tracking on makes the analyzer search every new trace for the specified target value and put the active marker on that point. If bandwidth search is on, tracking searches every new trace for the specified bandwidth, and repositions the dedicated bandwidth markers.

When tracking is off, the target is found on the current sweep and remains at the same stimulus value regardless of changes in trace response value with subsequent sweeps.

A maximum and a minimum point can be tracked simultaneously using two channels and uncoupled markers.

**[RETURN]** goes back to the marker function menu.

## Target Menu

The target menu places the marker at a specified target response value on the trace, and provides search right and search left options. If there is no occurrence of the specified value, the message "TARGET VALUE NOT FOUND" is displayed.

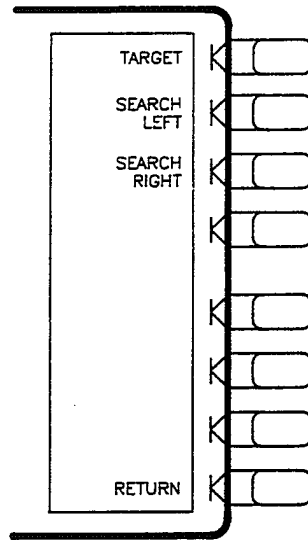

Figure 7-73. Target Menu

**[TARGET]** (SEATARG) places the marker at the specified target response value. If tracking is on (see previous menu) the target is automatically tracked with each new trace. If tracking is off, the target is found each time this key is pressed. The target value is in units appropriate to the current format. The default target value is  $-3$  dB.

In delta marker mode, the target value is the value relative to the reference marker. If no delta reference marker is on, the target value is an absolute value.

**[SEARCH LEFT]** (SEAL) searches the trace for the next occurrence of the target value to the left.

**[SEARCH RIGHT]** (SEAR) searches the trace for the next occurrence of the target value to the right.

**[RETURN]** goes back to the marker search menu.

# Chapter 8. Stimulus Function Block

---

## CHAPTER CONTENTS

- 8-1 Introduction
- 8-2 **[START]**, **[STOP]**, **[CENTER]**, and **[SPAN]** Keys
- 8-2 **[MENU]** Key
- 8-3 Stimulus Menu
- 8-6 Power Menu
- 8-7 Trigger Menu
- 8-8 Sweep Type Menu
- 8-11 Single/All Segment Menu
- 8-12 Edit List Menu
- 8-13 Edit Segment Menu

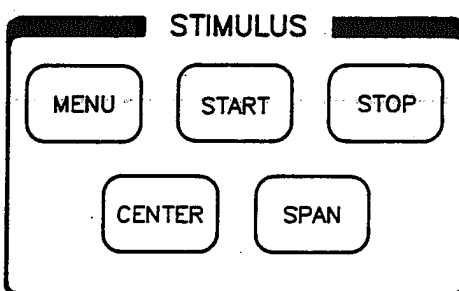

Figure 8-2. Stimulus Function Block

## INTRODUCTION

The stimulus function block keys and associated menus define and control the source RF output signal to the device under test. The source signal can be swept over any portion of the instrument's frequency and power range. The stimulus keys also control the start and stop times in the optional time domain mode. The menus are used to set all other source characteristics such as sweep time and resolution, source RF power level, and the number of data points taken during the sweep.

The HP-IB programming command is shown in parenthesis following the key or softkey.

## **[START], [STOP], [CENTER], AND [SPAN] KEYS**

The HP-IB programming command is shown in parenthesis following the key or softkey.

**[START]** (STAR)  
**[STOP]** (STOP)  
**[CENTER]** (CENT)  
**[SPAN]** (SPAN)

These keys define the frequency range or other horizontal axis range of the stimulus. The range can be expressed as either start/stop or center/span. When one of these keys is pressed, its function becomes the active function. The value is displayed in the active entry area and can be changed with the knob, step keys, or numeric keypad. Current stimulus values for the active channel are also displayed along the bottom of the graticule. Frequency values can be set to zero for security purposes, using the display menus.

The preset stimulus mode is frequency. In the time domain (option 010) or in CW time mode, the stimulus keys refer to time (with certain exceptions that are explained in "Time Domain"). In power sweep, the stimulus value is in dBm.

Because the display channels are independent, the stimulus signals for the two channels can be uncoupled and their values set independently. The values are then displayed separately on the display if the instrument is in dual channel display mode. In the uncoupled mode with dual channel display the instrument takes alternate sweeps to measure the two sets of data. Channel stimulus coupling is explained in this chapter, and dual channel display capabilities are explained in Chapter 7, *Response Function Block*.

## **[MENU] KEY**

The HP-IB programming command is shown in parenthesis following the key or softkey.

The **[MENU]** (MENUSTIM) key provides access to the series of menus illustrated in Figure 8-1, which define and control all stimulus functions other than start, stop, center, and span. When the **[MENU]** key is pressed, the stimulus menu is displayed. This in turn provides access to the other softkey menus. The functions available in these menus are described in the following pages.

## Stimulus Menu

The stimulus menu specifies the sweep time, number of measurement points per sweep, and CW frequency. It includes the capability to couple or uncouple the stimulus functions of the two display channels, and the measurement restart function. In addition, it leads to other softkey menus that define power level, trigger type, and sweep type. The individual softkey functions of the stimulus menu are described below.

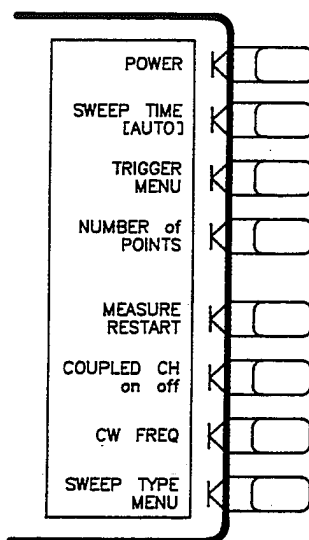

Figure 8-3. Stimulus Menu

**[POWER]** (POWE) makes power level the active function and presents the power menu, which is used to set the output power level and slope compensation of the built-in source.

**[SWEEP TIME [ ] ]** (SWET) toggles between automatic and manual sweep time. The following explains the difference between automatic and manual sweep time:

- **Manual Sweep Time.** As long as the selected sweep speed is within the capability of the instrument, it will remain fixed, regardless of changes to other measurement parameters. If the operator changes measurement parameters such that the instrument can no longer maintain the selected sweep time, the analyzer will change to the best sweep time possible. Manual mode is turned on by entering a sweep time (other than zero).
- **Auto Sweep Time.** Auto sweep time continuously maintains the fastest sweep speed possible with the selected measurement parameters. Auto sweep time is turned on by entering a sweep time of 0 [x1].

Sweep time refers only to the time that the instrument is sweeping and taking data, and does not include the time required for internal processing of the data. A sweep speed indicator ↑ is displayed on the trace for sweep times slower than 1.0 second. For sweep times faster than 1.0 second the ↑ indicator is displayed in the status notations area at the left of the display.

**Minimum Sweep Time.** The minimum sweep time is dependent on several factors. These factors are referred to as “measurement parameters” in the following paragraphs.

- The number of points selected.
- IF bandwidth.
- Sweep-to-sweep averaging in dual channel display mode.
- Smoothing.
- Limit lines.
- Error correction.
- Trace math.
- Marker statistics.
- Time domain.
- Type of sweep.

The following table is a partial guide for determining the minimum sweep time for the listed measurement parameters. The values listed represent the minimum time required for a CW time measurement with averaging off. Values are given in seconds.

Number of Points	IF Bandwidth			
	3000 Hz	1000 Hz	300 Hz	10 Hz
11	0.0055	0.012	0.036	1.14
51	0.0255	0.06	0.166	5.3
101	0.0505	0.12	0.328	10.5
201	0.1005	0.239	0.653	20.9
401	0.2005	0.476	1.303	41.7
801	0.4005	0.951	2.603	83.3
1601	0.8005	1.901	5.203	166.5

**[TRIGGER MENU]** presents the trigger menu, which selects the type and number of the sweep trigger.

**[NUMBER OF POINTS] (POIN)** selects the number of data points per sweep. Using fewer points allows a faster sweep time but the displayed trace shows less horizontal detail. Using more points gives greater data density and improved trace resolution, but slows the sweep and requires more memory for error correction or saving instrument states.

The available number of points are 3, 11, 26, 51, 101, 201, 401, 801, and 1601. The number of points can be different for the two channels if the stimulus values are uncoupled (by pressing **[COUPLED CH OFF]**).

In list frequency sweep, the number of points displayed is the total number of frequency points for the defined list (see "Sweep Type Menu").

**[MEASURE RESTART]** (REST) aborts the sweep in progress, then restarts the measurement. This can be used to update a measurement following an adjustment of the device under test.

If the analyzer is taking a number of groups (see *Trigger Menu*), the sweep counter is reset at 1. If averaging is on, **[MEASURE RESTART]** resets the sweep-to-sweep averaging and is effectively the same as **[AVERAGING RESTART]**. If the sweep trigger is in **[HOLD]** mode, **[MEASURE RESTART]** executes a single sweep.

**[COUPLED CH on OFF]** (COUCON, COUCOFF) toggles the channel coupling of stimulus values. With **[COUPLED CH ON]** (the preset condition), both channels have the same stimulus values (the inactive channel takes on the stimulus values of the active channel).

In the stimulus coupled mode, the following parameters are coupled:

- Frequency.
- Source power.
- Power slope.
- Sweep time.
- Trigger type.
- Sweep type.
- Number of points.
- Number of groups.
- IF bandwidth.
- Time domain transform.
- Gating.

Coupling of stimulus values for the two channels is independent of **[DUAL CHAN on OFF]** in the display menu and **[MARKERS: UNCOUPLED]** in the marker mode menu. **[COUPLED CH OFF]** becomes an alternate sweep function when dual channel display is on: in this mode the analyzer alternates between the two sets of stimulus values for measurement of data.

**[CW FREQ]** (CWFREQ) sets the frequency for power sweep and CW time sweep modes. If the instrument is not in either of these two modes, it is automatically switched into CW time mode.

**[SWEEP TYPE MENU]** presents the sweep type menu, where one of the available types of stimulus sweep can be selected.



## Power Menu

The power menu sets the output power level of the source, and sets power slope to compensate for measured power loss with frequency.

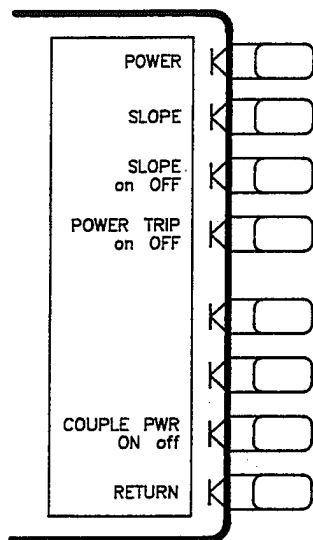

Figure 8-4. Power Menu

**[POWER]** (POWE) makes power level the active function and sets the RF output power level of the analyzer's internal source. The analyzer will detect an input power overload at any of the three receiver inputs, and automatically reduce the output power of the source to  $-20$  dBm. This is indicated with the message "POWER TRIPPED press **[POWER]** **[POWER TRIP]**." In addition, the **[POWER TRIP ON]** flag (see below) is set, and the annotation "P↓" appears at the left side of the display. When this occurs, toggle the power trip off and set the power to a lower level.

If the source power is unlevelled at the start or stop of a sweep, the notation "P?" is displayed at the left of the display. This indicates that the automatic leveling control circuit of the source is unable to keep the source power leveled to instrument specifications, and the power is therefore potentially uncalibrated. The "P?" notation is removed only after a sweep in which the source power is detected to be leveled at both the start and stop of the sweep. Refer to the *Service Manual* for troubleshooting information.

**[SLOPE]** (SLOPE) compensates for power loss versus the frequency sweep by sloping the output power upwards proportionally to frequency. Use this softkey to enter the power slope in dB per GHz of sweep.

**[SLOPE on OFF]** (SLOPON, SLOPOFF) toggles the power slope function on or off. With slope on, the output power increases with frequency, starting at the selected power level.

**[POWER TRIP on OFF]** (POWTON, POWTOFF) toggles the power trip function on or off. Power trip is a reduced power state triggered by a power overload. It forces the source output power to  $-20$  dBm regardless of the user-specified power level. The trip is set automatically whenever a power overload is detected on an input channel. When trip is on, the annotation "P↓" appears in the status notations area of the display.

To reset the power level following a power trip, toggle the power trip **OFF**.

**[COUPLE PWR ON off]** This command is not used in the HP 8752.

**[RETURN]** goes back to the stimulus menu.

## Trigger Menu

This menu is used to select the type and number of the sweep trigger.

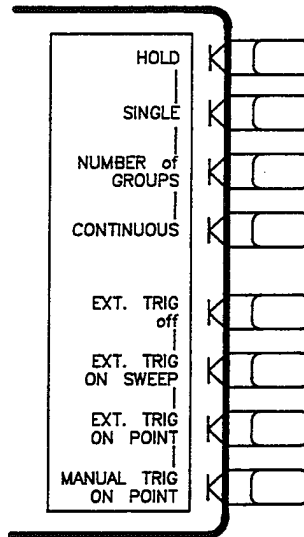

Figure 8-5. Trigger Menu

**[HOLD]** (HOLD) freezes the data trace on the display, and the analyzer stops sweeping and taking data. The notation "Hld" is displayed at the left of the graticule. If the \* indicator is on at the left side of the display, trigger a new sweep with **[SINGLE]**.

**[SINGLE]** (SING) takes one sweep of data and returns to the hold mode.

**[NUMBER OF GROUPS]** (NUMG) triggers a user-specified number of sweeps, and returns to the hold mode.

If averaging is on, the number of groups should be at least equal to the averaging factor selected to allow measurement of a fully averaged trace. Entering a number of groups resets the averaging counter to 1.

**[CONTINUOUS]** (CONT) is the standard sweep mode of the analyzer, in which the sweep is triggered automatically and continuously and the trace is updated with each sweep.

**[TRIGGER: TRIG OFF]** (EXTTOFF) turns off external trigger mode.

**[EXT TRIG ON SWEEP]** (EXTTON) is used when the sweep is triggered on an externally generated signal connected to the rear panel EXT TRIGGER input. The sweep is started with a high-to-low transition of a TTL signal. If this key is pressed when no external trigger signal is connected, the notation "Ext" is shown at the left side of the display to indicate that the analyzer is waiting for a trigger. When a trigger signal is connected, the "Ext" notation is replaced by the sweep speed indicator  $\uparrow$  either in the status notations area or on the trace. External trigger mode is allowed in every sweep mode.

**[EXT TRIG ON POINT]** (EXTTPOIN) is similar to the trigger on sweep, but triggers each data point in a sweep.

**[MANUAL TRG ON POINT]** (MANTRIG) waits for a manual trigger for each point. Subsequent pressing of this softkey triggers each measurement. The annotation "man" will appear at the left side of the display when the instrument is waiting for the trigger to occur. This feature is useful in a test sequence when an external device or instrument requires changes at each point.

## Sweep Type Menu

Five sweep types are available:

- Linear frequency sweeps in Hz. In the linear frequency sweep mode it is possible, with option 010, to transform the data for time domain measurements using the inverse Fourier transform technique.
- Logarithmic frequency sweeps in Hz.
- Power sweeps in dBm.
- CW time sweep in seconds. In the CW time sweep mode, the data can be transformed for frequency domain measurements. Refer to the "Time Domain" section for detailed information about time domain transform (option 010).
- List frequency sweep in Hz. A new feature is the single segment mode, where any single segment in a frequency list may be selected. The single segment will retain the same error correction as the original list of frequencies.

**Interpolated Error Correction.** The interpolated error correction feature will function with the following sweep types:

- Linear frequency
- Power sweep
- CW time

Interpolated error correction will not work in log or list sweep modes. Refer to the Measurement Calibration section for more information on interpolated error correction.

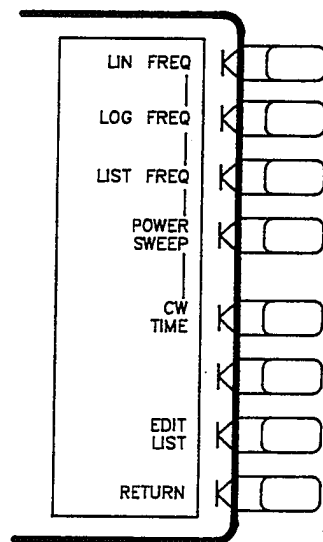

Figure 8-6. Sweep Type Menu

**[LIN FREQ]** (LINFREQ) activates a linear frequency sweep displayed on a standard graticule with ten equal horizontal divisions. This is the default preset sweep type.

For a linear sweep, sweep time is combined with the channel's frequency span to compute a source sweep rate:

$$\text{sweep rate} = (\text{frequency span}) / (\text{sweep time})$$

Since the sweep time may be affected by various factors (see "Stimulus Menu"), the equation provided here is merely an indication of the ideal (maximum) sweep rate. If the user-specified sweep time is greater than 15 ms times the number of points, the sweep changes from a continuous ramp sweep to a stepped CW sweep. Also, for narrow IF bandwidths the sweep is automatically converted to a stepped CW sweep.

**[LOG FREQ]** (LOGFREQ) activates a logarithmic frequency sweep mode. The source is stepped in logarithmic increments and the data is displayed on a logarithmic graticule. This is slower than a continuous sweep with the same number of points, and the entered sweep time may therefore be changed automatically. For frequency spans of less than two octaves, the sweep type automatically reverts to linear sweep.

**[LIST FREQ]** (LISTFREQ) Activates the frequency list mode, and presents the "Single Segment Sweep/All Segment Sweep Menu".

**Frequency list mode** allows you to measure DUT response over several distinct frequency ranges or at specific frequency points. Up to 30 ranges (or points) can be specified in any combination. Each entry in the frequency list is called a *Segment*, regardless of it being a frequency range or single point.

The **[LIST FREQ]** softkey also presents the "Single Segment Sweep/All Segment Sweep Menu", which enables all the segments in your list; or any one segment.

Before you can use frequency list mode, you must create the frequency list using the instructions after the Sweep Type Menu description.

**Using frequency list mode with a user-performed calibration.** If you need to use a user-performed calibration, do the calibration with all segments on. When done, you can display any one of the segments in the list and the calibration will remain valid.

**[POWER SWEEP]** (POWS) turns on a power sweep mode that is used to characterize power-sensitive circuits. In this mode, power is swept at a single frequency, from a start power value to a stop power value, selected using the **[START]** and **[STOP]** keys and the entry block. This feature is convenient for such measurements as gain compression or AGC (automatic gain control) slope. To set the frequency of the power sweep, use **[CW FREQ]** in the stimulus menu. Refer to the *User's Guide* for an example of a gain compression measurement.

In power sweep, the entered sweep time may be automatically changed if it is less than the minimum required for the current configuration (number of points, IF bandwidth, averaging, etc.).

**[CW TIME]** (CWTIME) turns on a sweep mode similar to an oscilloscope. The analyzer is set to a single frequency, and the data is displayed versus time. The frequency of the CW time sweep is set with **[CW FREQ]** in the stimulus menu. In this sweep mode, the data is continuously sampled at precise, uniform time intervals determined by the sweep time and the number of points minus 1. The entered sweep time may be automatically changed if it is less than the minimum required for the current instrument configuration.

In time domain (option 010), the CW time mode data is translated to frequency domain, and the x-axis becomes frequency. This can be used like a spectrum analyzer to measure signal purity, or for low frequency (>1 kHz) analysis of amplitude or pulse modulation signals. For details, refer to the "Time Domain" section.

**[EDIT LIST]** presents the edit list menu. This is used in conjunction with the edit subsweep menu to define or modify the frequency sweep list. The list frequency sweep mode is selected with the **[LIST FREQ]** softkey described above.

**[RETURN]** goes back to the stimulus menu.

## CREATING A FREQUENCY LIST

Example: This example tests a DUT with one frequency range segment, and one single frequency segment.

1. Press **[MENU] [SWEEP TYPE MENU] [EDIT LIST] [ADD] [SEGMENT: START] 1 [M/μ]**. This creates the first segment, and defines its start frequency (1 MHz).
2. Press **[STOP] 100 [M/μ]**. This sets the end of the segment to 100 MHz.
3. Press **[NUMBER of POINTS] 100 [x1]**. This sets the number of measurement points in this particular segment to 100.

**NOTE:** For each frequency range you can select a different **[NUMBER of POINTS]**, but the total points in your frequency list cannot exceed 1632.

4. Press **[DONE]**.

This completes the first segment. To create a second segment (a single frequency point), perform the following:

5. Continuing from the above steps, press **[ADD]**. This duplicates the last segment you created.
6. Press **[CW FREQ]**, notice the number of points revert to 1, and the START and STOP columns change to CENTER and SPAN. The SPAN entry automatically changes to zero for this new segment, and the CENTER value matches that of the last segment.
7. Press **150 [M/μ]** to finish the CW frequency entry, followed by **[DONE]**.
8. Press **[DONE]** again, and activate the frequency list mode by pressing **[LIST FREQ]**. At this time, the instrument activates all frequency list segments, and displays the Single Segment Sweep/All Sweeps Menu.
9. If you only want to use one of the segments, press **[SINGLE SEG SWEEP]**, the frequency list will appear on the screen. Move the > cursor to the desired segment (using the front panel knob) and press **[RETURN]**. No further action is required.

## Editing a Segment

To edit a segment, follow the instructions below:

1. Press **[MENU] [SWEEP TYPE MENU] [EDIT LIST] [SEGMENT]**.
2. Move the > cursor next to the segment you wish to change using the knob. In this example, select the first segment created above (segment 1).

**NOTE:** Pressing **[DELETE]** now would delete segment 1.

3. Press **[EDIT]** and make the desired changes. For example, press **[SEGMENT START] 50 [M/μ]**. Notice the columns change again, from CENTER and SPAN to START and STOP values.
4. Press **[DONE]**. The change is implemented immediately, assuming you have not turned frequency list mode off.

## Printing the Frequency List

The list can be printed by using the **[LIST VALUES]** function in the Copy Menu. Refer to the "Printing and Plotting" section for details.

## Single/All Segment Menu

When this menu is presented, the frequency list table is also displayed. Any single segment, or all segments can be selected.

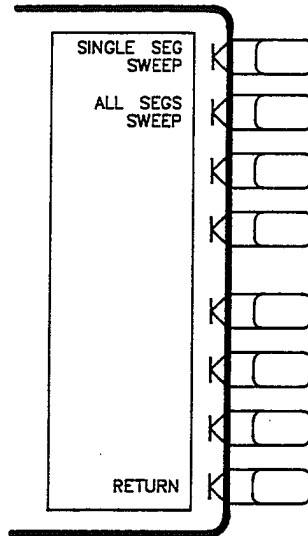

Figure 8-7. Single/All Segment Menu

**[SINGLE SEG SWEEP]** (SSEG) enables a measurement of a single segment of the frequency list, without loss of any user-performed calibration. The segment to be measured is selected using the knob.

In single segment mode, selecting a (user-performed) measurement calibration will force the full list sweep before prompting for calibration standards. The calibration will then be valid for any single segment.

If an instrument state is saved in memory with a single-segment trace, recall will re-display that segment while also recalling the entire list.

**[ALL SEGS SWEEP]** (ASEG) retrieves the full frequency list sweep.

**[RETURN]** goes back to the sweep type menu.

## Edit List Menu

This menu is used to edit the list of frequency segments defined with the edit segment menu, described next. Up to 30 frequency segments can be specified, for a maximum of 1632 points. The segments do not have to be entered in any particular order: the analyzer automatically sorts them and lists them on the display in increasing order of start frequency. This menu determines which entry on the list is to be modified, while the edit segment menu changes the frequency or number of points of the selected segment.

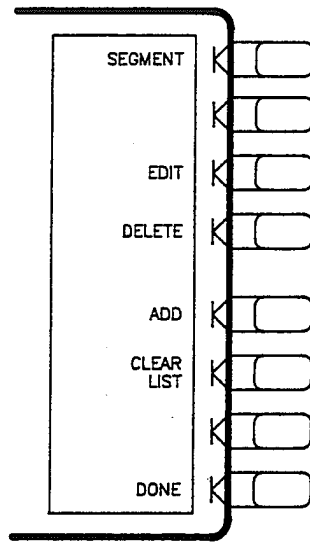

Figure 8-8. Edit List Menu

**[SEGMENT]** determines which segment on the list is to be modified. Enter the number of a segment in the list, or use the knob to scroll the pointer > to the left of the required segment number. The indicated segment can then be edited or deleted.

**[EDIT]** goes to the edit segment menu, where the segment indicated by the pointer > can be modified.

**[DELETE]** deletes the segment indicated by the pointer >.

**[ADD]** adds a new segment. If the list is empty, a default segment is added, and the edit segment menu is displayed. If the list is not empty, the segment indicated by the pointer > is copied and the edit segment menu is displayed.

**[CLEAR LIST]** clears the entire list.

**[DONE]** sorts the frequency points and returns to the sweep type menu.

## Edit Segment Menu

This menu sets the start and stop, center and span, or CW frequencies for the selected segment. It also sets number of points or step size, explained below. For example the sweep could include 100 points in a narrow passband, 100 points across a broad stop band, and 50 points across the third harmonic response. The total sweep is defined with a list of segments.

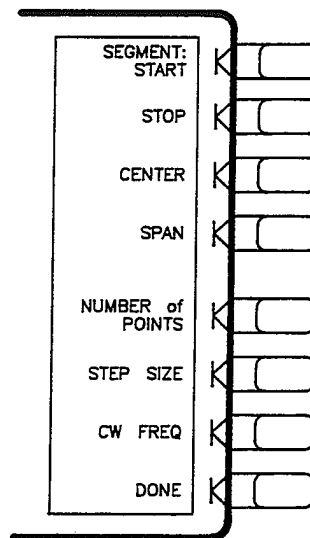

Figure 8-9. Edit Segment Menu

The frequency segments can be defined in any of the following terms:

- Start / stop / number of points
- Start / stop / step
- Center / span / number of points
- Center / span / step
- CW frequency

The segments can overlap, and do not have to be entered in any particular order. The analyzer sorts them automatically and lists them on the display in order of increasing start frequency, even if they are entered in center/span format. If duplicate frequencies exist, the analyzer makes multiple measurements on identical points to maintain the specified number of points for each segment. The data is displayed as a single trace that is a composite of all data taken. The trace may appear uneven because of the distribution of the data points, but the frequency scale is linear across the total range.

The list frequency sweep mode is selected with the **[LIST FREQ]** softkey in the sweep type menu.

The frequency list parameters can be saved with an instrument state.

**[SEGMENT START]** sets the start frequency of a segment.

**[STOP]** sets the stop frequency of a segment.

**[CENTER]** sets the center frequency of a segment.



**[SPAN]** sets the frequency span of a segment about a specified center frequency.

**[NUMBER OF POINTS]** sets the number of points for the segment. The total number of points for all the segments cannot exceed 1632.

**[STEP SIZE]** is used to specify the segment in frequency steps instead of number of points. Changing the start frequency, stop frequency, span, or number of points may change the step size. Changing the step size may change the number of points and stop frequency in start/stop/step mode; or the frequency span in center/span/step mode. In each case, the frequency span becomes a multiple of the step size.

**[CW]** is used to set a segment consisting of a single CW frequency point.

**[DONE]** returns to the edit list menu.

## Chapter 9. Entry Block

### ENTRY BLOCK KEYS

The ENTRY block, illustrated in Figure 9-1, provides the numeric and units keypad, the knob, and the step keys. These are used in combination with other front panel keys and softkeys to modify the active entry, to enter or change numeric data, and to change the value of the active marker. In general the keypad, knob, and step keys can be used interchangeably.

Before a function can be modified, it must be made the active function by pressing a front panel key or softkey. It can then be modified directly with the knob, the step keys, or the digits keys and a terminator, as described below.

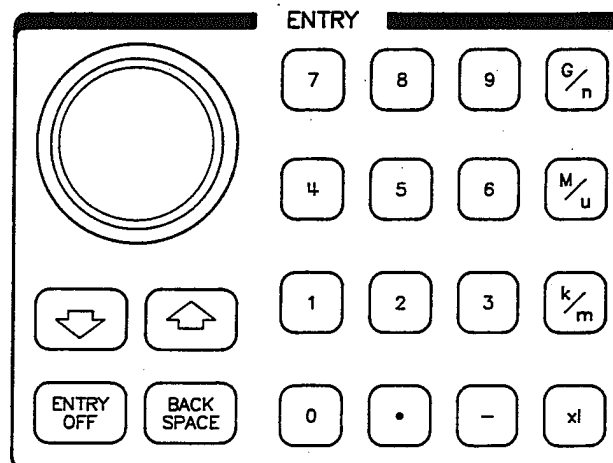

Figure 9-1. Entry Block Keys

The numeric keypad is used to select digits, decimal point, and minus sign for numerical entries. A units terminator is required, as described below.

The units terminator keys are the four keys in the right-hand column of the keypad. These specify units of numerical entries from the keypad and at the same time terminate the entries. A numerical entry is incomplete until a terminator is supplied, and this is indicated by the data entry arrow ← pointing at the last entered digit in the active entry area. When the units terminator key is pressed, the arrow is replaced by the units selected. The units are abbreviated on the terminator keys as follows:

G/n (HP-IB G, N) = Giga/nano ( $10^9 / 10^{-9}$ )  
M/ $\mu$ (M, U) = Mega/micro ( $10^6 / 10^{-6}$ )  
k/m (K, M) = kilo/milli ( $10^3 / 10^{-3}$ )  
x1 (HZ, S, DB, V) = basic units: dB, dBm, degrees, seconds, Hz, or dB/GHz (may be used to terminate unitless entries such as averaging factor)

The knob makes continuous adjustments to current values for functions such as scale, reference level, and others. If a marker is turned on, and no other function is active, the knob can adjust the marker position. Values changed by the knob are effective immediately, and require no units terminator.

The step keys [ $\blacktriangle$ ] and [ $\blacktriangledown$ ] are used to step the current value of the active function up or down. The steps sizes are predetermined and cannot be altered. No units terminator is required with these two keys. For editing a test sequence, these keys allow you to scroll through the displayed sequence. The HP-IB equivalent commands for [ $\blacktriangle$ ] and [ $\blacktriangledown$ ] are UP and DOWN, respectively.

**[ENTRY OFF]** (ENTO) clears and turns off the active entry area, as well as any displayed prompts, error messages, or warnings. Use this function to clear the display before plotting. This softkey also prevents changing of active values by accidentally moving the knob. The next selected function turns the active entry area back on.

**[BACK SPACE]** deletes the last entry, or the last digit entered from the number pad. For modifying a test sequence, the backspace key may be used in one of two ways:

- If pressed when modifying a single-key command like **[TRANSMISSN]**, the backspace key deletes the command.
- If pressed when entering a number like **[START] [1] [2]**, and you have not yet pressed a terminator key (**[G/n]**, etc), the backspace key will delete the last digit (in this example the 2 will be deleted).

## Chapter 10. Instrument State Block

### CONTENTS

- 10-2 Instrument state block functions and where they are described
- 10-2 SYSTEM key menu
- 10-4 LOCAL key menu
- 10-4 HP-IB menu (system control mode, pass control, talker/listener modes)
- 10-7 Address menu (setting instrument and peripheral addresses)

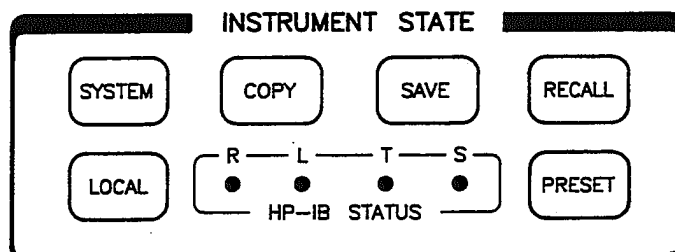

Figure 10-1. Instrument State Block

### INTRODUCTION

The only feature explained in this tab section is the [LOCAL] key and its related softkey menus. Other Instrument State Block functions are explained in following tab sections.

The instrument state function block keys and associated menus provide control of channel-independent system functions. These include sequencing, controller modes, instrument addresses, HP-IB status information, plotting or printing, and saving instrument states either in internal memory or to an external disk drive.

## INSTRUMENT STATE FUNCTIONS AND WHERE THEY ARE DESCRIBED

Functions accessible in the instrument state function block are divided up among several tabs in this manual. Service options are described in the *Service Manual*.

Table 10-1. Instrument State Functions and Where They Are Described

Instrument State Key	Function	Location
[SYSTEM]	Limit Lines and Limit Testing Test Sequence Function Time Domain Transform Service Menu	Limit Lines Tab Test Sequencing Tab Time Domain Tab <i>Service Manual</i>
[COPY]	All Features – including printing and plotting.	Printing and Plotting Tab
[SAVE]	All Features – including saving and recalling instrument states to/from memory or external disk.	Save and Recall Tab
[RECALL]		
[LOCAL]	All Features – including HP-IB and address menus.	In this tab section
[PRESET]	Preset State	Preset Key Tab

### [SYSTEM] KEY (MENUSYST)

Pressing this key presents the system menu.

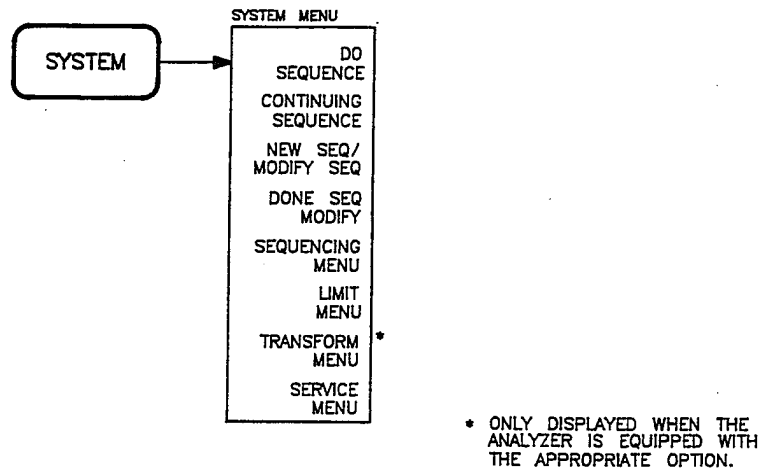

Figure 10-2. The System Menu

The first four softkeys in this menu are devoted to commonly used test sequencing functions. Sequencing allows the instrument to memorize a series of keystrokes and execute them automatically on command. The common sequencing tasks covered are running a sequence (DO SEQUENCE), continuing a paused sequence, creating/editing a sequence, and ending the creation/editing process (DONE SEQ MODIFY).

**[DO SEQUENCE]** (DOSEQn) has two functions:

- It shows the current sequences residing in memory. To run one of them, press the softkey next to the appropriate sequence name.
- When entered into a sequence, this command performs a one-way jump to another sequence.

Refer to the test sequencing section for more information.

**[CONTINUE SEQUENCE]** resumes sequence operation. A sequence will pause during execution if it encounters the sequencing PAUSE command. This allows the operator to change test setup or insert a new device under test. The user is prompted to press this key to continue sequence operation. Refer to the test sequencing section for more information.

**[NEW SEQ/MODIFY SEQ]** (NEWSEQn) activates the edit mode and presents the new/modify sequence menu with a list of sequences that can be created or modified. Refer to the test sequencing section for more information.

**[DONE SEQ MODIFY]** (DONM) terminates the edit mode. Refer to the test sequencing section for more information.

**[SEQUENCING MENU]** leads to lesser-used sequencing functions, including:

- Disk utilities such as saving, loading, viewing and deleting sequence files on disk. Also, clearing sequences from memory.
- General functions such as naming, printing and clearing sequences (from memory).
- Advanced sequence functions. Decision making (based on limit testing or the value of a loop counter), pause, wait, beep, and other functions are available.

Refer to the test sequencing section for more information.

**[LIMIT MENU]** leads to a series of menus used to define test limits which are displayed on the screen. The instrument can display pass or fail messages based on test results (if desired). Refer to the limit lines section for more information.

**[TRANSFORM MENU]** (option 010) leads to a series of menus that transform the measured data from the frequency domain to the time domain. This softkey is present only in instruments purchased with option 010. Refer to the time domain section for more information.

**[SERVICE MENU]** leads to a series of service menus described in detail in the *Service Manual*.

## LOCAL KEY

The [LOCAL] key summons the following menus:

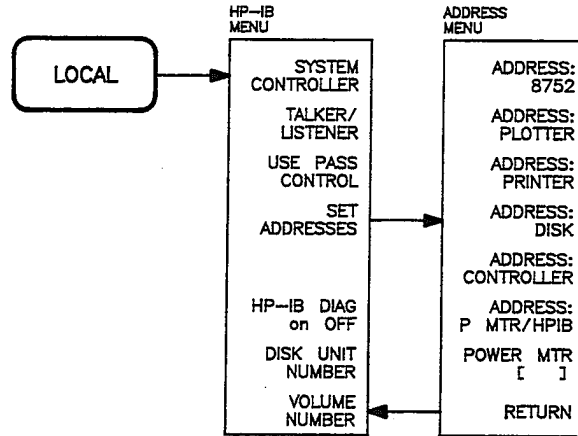

Figure 10-3. Softkey Menus Accessed from the [LOCAL] Key

This key performs the following functions:

- It returns front panel control to the user. The instrument ignores all front panel keys (except the [LOCAL] key) when under the control of an external computer. The instrument is in “local mode” when the user has front panel control. The instrument is in “remote mode” when an external computer controls the instrument.
- It aborts a test sequence, printout, or plot.
- It summons either the HP-IB menu or the address menu. The HP-IB menu sets the controller mode. The address menu is where the HP-IB addresses of peripheral devices are entered. The controller mode determines which device controls the HP-IB bus, the instrument or the computer. Only one of them can control the bus.

## LOCAL LOCKOUT

Local lockout is a remote (computer generated) command that disables the [LOCAL] key, making it difficult to interfere with the instrument while it is under computer control.

## HP-IB MENU

This menu indicates the present HP-IB controller mode of the HP 8752. Three HP-IB modes are possible: system controller, talker/listener, and pass control.

## **Talker/Listener Mode**

Talker/listener is the mode of operation most often used. In this mode, a computer communicates with the instrument and other compatible peripherals over the bus. The computer sends commands or instructions to and receives data from the network analyzer. All of the capabilities available from the instrument front panel can be used in this remote operation mode, except for some internal tests.

## **System Controller Mode**

In the system controller mode, the instrument itself can control compatible peripherals. It can output measurement results directly to a printer or plotter, store instrument states using a disk drive, or control a power meter for performing service routines.

## **Pass Control Mode**

In an automated system with a computer controller, the computer can pass control of the bus to the network analyzer when the instrument requests it. The network analyzer is then the controller of the peripherals, and can direct them to plot, print, or store without going through the computer. When the peripheral operation is complete, control is passed back to the computer. Only one controller can be active at a time. In this mode the computer is still the system controller, and can take control back at any time.

Preset does not affect the selected controller mode, but cycling the power returns the instrument to talker/listener mode.

Information on compatible peripherals is provided in the "General Information" section of this manual.

**HP-IB Status Indicators.** When the network analyzer is connected to other instruments over HP-IB, the HP-IB STATUS indicators in the instrument state function block light up to display the current status.

R = Remote operation.

L = Listen mode.

T = Talk mode.

S = Service request (SRQ) asserted by the network analyzer.

Information on HP-IB operation is provided in "HP-IB Programming".



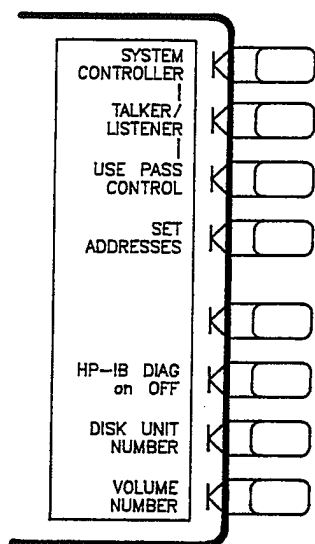

Figure 10-4. HP-IB Menu

**[SYSTEM CONTROLLER]** is the mode used when peripheral devices are to be used and there is no external controller. Refer to the description above.

The system controller mode can be used without knowledge of HP-IB programming. However, the HP-IB address must be entered for each peripheral device.

This mode can only be selected manually from the network analyzer front panel, and can be used only if no active computer controller is connected to the system through HP-IB. If you try to set system controller mode when a computer is present, the message "CAUTION: CAN'T CHANGE - ANOTHER CONTROLLER ON BUS" is displayed. Do not attempt to use this mode for remote programming.

**[TALKER/LISTENER]** (TALKLIST) is the mode normally used for remote programming of the network analyzer. In this mode, the network analyzer and all peripheral devices are controlled from the external controller. The controller can command the network analyzer to talk, and the plotter or other device to listen. The network analyzer and peripheral devices cannot talk directly to each other unless the computer sets up a data path between them.

This mode allows the network analyzer to be either a talker or a listener, as required by the controlling computer for the particular operation in progress.

A talker is a device capable of sending out data when it is addressed to talk. There can be only one talker at any given time. The network analyzer is a talker when it sends information over the bus.

A listener is a device capable of receiving data when it is addressed to listen. There can be any number of listeners at any given time. The network analyzer is a listener when it is controlled over the bus by a computer.

**[USE PASS CONTROL]** (USEPASC) lets you control the network analyzer with the computer over HP-IB as with the talker/listener mode, and also allows the network analyzer to become a controller in order to plot, print, or directly access an external disk drive. During this peripheral operation, the host computer is free to perform other internal tasks that do not require use of the bus (the bus is being used by the network analyzer during this time).

The pass control mode requires that the external computer is programmed to respond to a request for control and to issue a take control command. When the peripheral operation is complete, the network analyzer passes control back to the computer. Refer to the *HP-IB Programming Guide* behind the HP-IB Programming tab for more information.

In general, use the talker/listener mode for programming the network analyzer unless direct peripheral access is required.

**[SET ADDRESSES]** goes to the address menu, which is used to set the HP-IB address of the network analyzer, and to display and modify the addresses of peripheral devices in the system.

**[HP-IB DIAG on off]** (DEBUON, DEBUOFF) toggles the HP-IB diagnostic feature (debug mode). This mode should only be used the first time a program is written.

When diagnostics are on, the network analyzer scrolls a history of incoming HP-IB commands across the display in the title line. Nonprintable characters are represented as  $\pi$ . If a syntax error is received, the commands halt and a pointer  $\wedge$  indicates the misunderstood character. To clear a syntax error, refer to the *HP-IB Programming Guide*, behind the HP-IB Programming tab.

**[DISK UNIT NUMBER]** (DISCUNIT) specifies the number of the disk unit in the disk drive that is to be accessed in an external disk store or load routine. This is used in conjunction with the HP-IB address of the disk drive, and the volume number, to gain access to a specific area on a disk. The access hierarchy is HP-IB address, disk unit number, disk volume number. More information on storing information to an external disk is provided in "Save and Recall".

**[VOLUME NUMBER]** (DISCVOLU) specifies the number of the disk volume to be accessed. In general, all 3.5 inch floppy disks are considered one volume (volume 0). For hard disk drives, such as the HP 9153 (Winchester), a switch in the disk drive must be set to define the number of volumes on the disk. For more information, refer to the manual for the individual hard disk drive.

## ADDRESS MENU

In communications through the Hewlett-Packard Interface Bus (HP-IB), each instrument on the bus is identified by an HP-IB address. This decimal-based address code must be different for each instrument on the bus.

This menu sets the HP-IB address of the network analyzer. It also sets the HP-IB addresses the instrument will use when talking to each peripheral.

Most of the HP-IB addresses are set at the factory and need not be modified for normal system operation. The standard factory-set addresses for instruments that may be part of the system are as follows:

Instrument	HP-IB Address (decimal)
Network Analyzer	16
Plotter	05
Printer	01
External Disk Drive	00
Controller	21
Power Meter	13

The address displayed in this menu for each peripheral device must match the address set on the device itself. If the addresses do not match, they can be matched in one of two ways. Either the address set in the network analyzer can be changed (using the entry controls); or the actual address of the device can be changed using instructions provided in its manual. The HP 8752's HP-IB address is changed through the keyboard controls, there is no physical HP-IB switch.

These addresses are stored in short-term non-volatile memory and are not affected by preset or by cycling line power.

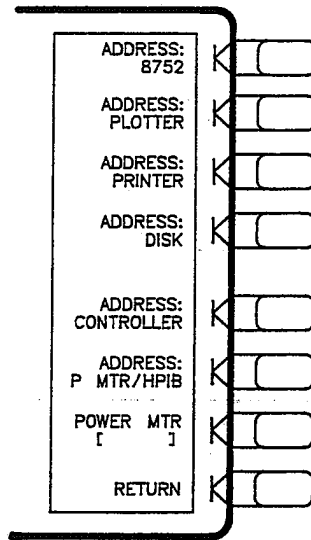

Figure 10-5. Address Menu

**[ADDRESS: 8752]** sets the HP-IB address of the network analyzer (using the entry controls). There is no physical HP-IB address switch.

**[ADDRESS: PLOTTER]** (ADDRPLOT) sets the HP-IB address the network analyzer uses to communicate with the plotter.

**[ADDRESS: PRINTER]** (ADDRPRIN) sets the HP-IB address the network analyzer uses to communicate with the printer.

**[ADDRESS: DISK]** (ADDRDISC) sets the HP-IB address the network analyzer uses to communicate with the disk drive.

**[ADDRESS: CONTROLLER]** (ADDRCONT) sets the HP-IB address the network analyzer uses to communicate with the external controller.

**[ADDRESS: P MTR/HPIB]** (ADDRPOWM) sets the HP-IB address the network analyzer uses to communicate with the power meter used in service routines.

**[POWER MTR]** (POWM) toggles between **[436A]** or **[438A/437]**. These power meters are HP-IB compatible with the network analyzer. The model number in the softkey label must match the power meter in use.

**[RETURN]** goes back to the HP-IB menu.

# LIMIT LINES and LIMIT TESTING

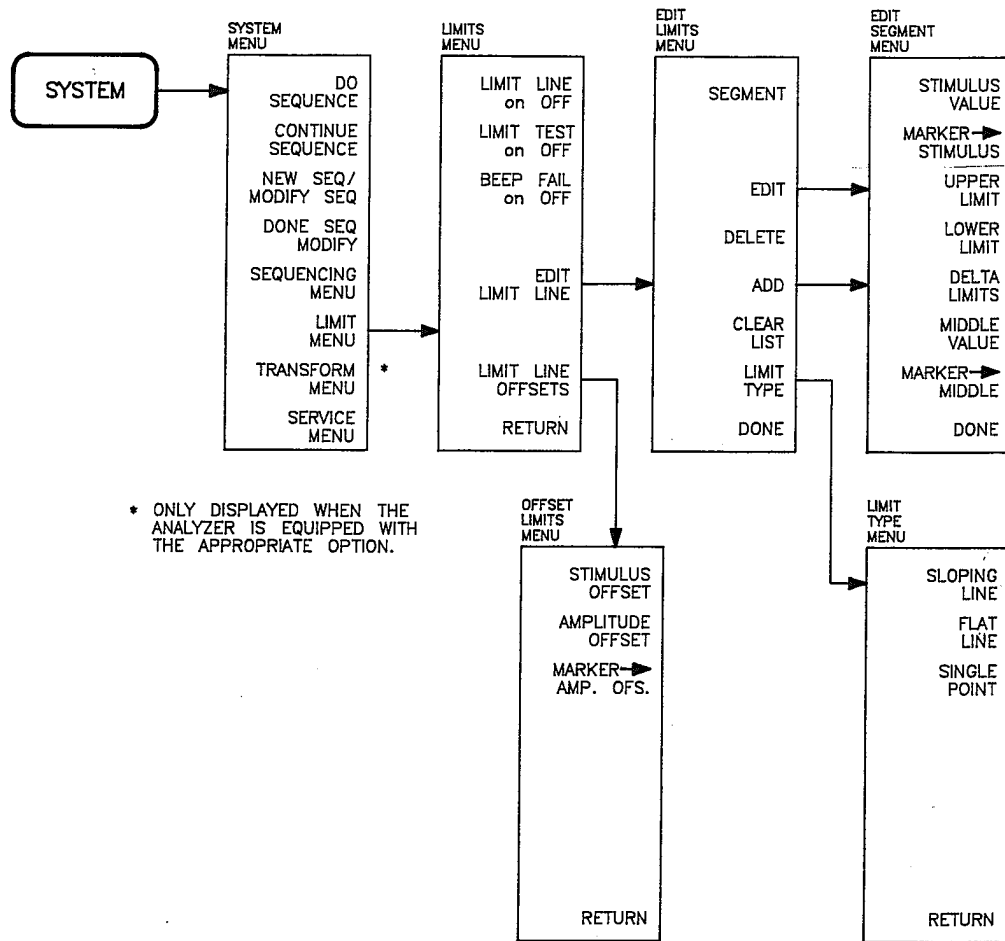

Refer to this foldout menu map as needed when using this tab section.

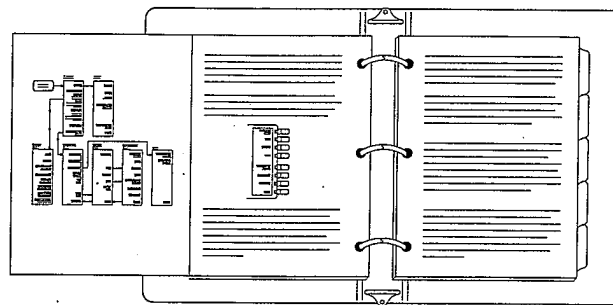

Figure 10-6. Limit Lines Menu Map

# Limit Lines and Limit Testing

## CONTENTS

10-11	What are limit lines and limit testing?
10-11	Limit lines and limit testing are independent functions
10-12	How limit lines are entered
10-14	Turning limit lines and limit testing on and off
10-14	Limit lines do not need to be entered in order
10-14	Saving the limit line table
10-14	Offsetting the stimulus or amplitude values of the limit lines
10-14	Supported display formats
10-14	Use a sufficient <b>[NUMBER OF POINTS]</b> or errors may occur
10-14	Displaying, printing, or plotting limit test data
10-15	Results of plotting or printing the display with limit lines on
10-15	Example of use
10-16	Limits menu
10-17	Edit limits menu
10-18	Edit segment menu
10-20	Limit type menu
10-22	Offset limits menu

## INTRODUCTION

This is a portion of Chapter 10, Instrument State Block. The main menu for this feature is accessed by first pressing the **[SYSTEM]** key.

## WHAT ARE LIMIT LINES AND LIMIT TESTING?

### Limit Lines and Limit Testing are Independent Functions

**Limit lines.** These are lines drawn on the display to represent upper and lower test limits. Used by itself, limit lines simply displays the selected upper and lower limits on the screen, and no pass/fail information is provided. Limit line parameters are entered in tabular format.

**Limit testing.** This is always used with the limit lines feature. The instrument can show whether the device under test (DUT) passed or failed the test limits. If limit lines are used with the sequencing feature, different tasks can be performed based on whether the DUT passed or failed.

An out-of-limit test condition is normally indicated in five ways:

- With a FAIL message on the screen.
- With a beep.
- By changing trace color.
- With an asterisk in tabular listings of data.
- With a bit in the HP-IB event status register B.

## How Limit Lines are Entered

**Understanding Segments.** Before limit lines can be explained the concept of “segments” must be made clear. A segment is a single point, it is *not* a line connecting two points. Refer to Figure 10-7.

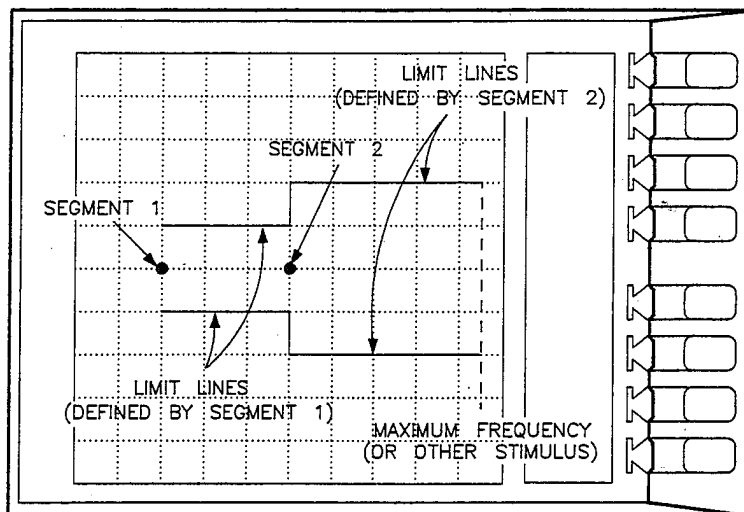

Figure 10-7. The Concept of Segments as a Single Stimulus Point, with Limit Lines Connecting Them

As you can see in the figure above, segments are distinct points that define where measurement limits (limit lines) begin and end. Limit lines span the distance between segment points and represent the upper and lower test limits. Figure 10-7 also shows another important aspect of limit lines: If no end segment is specified, a set of limit lines will continue until the maximum frequency (or other stimulus) is reached. This is the case with the limit lines started by segment 2.

A segment is placed at a specific stimulus value (a single frequency, for example). The first segment sets the starting point for a set of limit lines. Once its stimulus value is entered, the following needs to be supplied:

- The upper and lower test limits (+5 dB and -5 dB, for example).
- How the limit lines should span the distance between this first segment point and the next segment point (flat line or sloping line).

Defining a second segment defines where the first set of limit lines ends. This process is repeated to create different sets of limit lines, each having new upper and lower limits. Up to 18 segment points can be entered.

**Limit type.** The last parameter to be selected is the “limit type”. The limits you specify can apply between segments in either of two ways:

- Flat line – The limits stay the same from one segment to the next. The change in limits from one segment to the next will occur instantly, in a distinct step.

Example: Segment 1 is at 1 MHz and has an upper and lower limit of +5 and -5 dB, respectively. Segment 2 is at 2 MHz, and has an upper and lower limit of +10 and -10 dB. Segment 1’s limits (+5 and -5 dB) will apply, unchanged, up to 2 MHz, at which time they instantly change to +10 and -10 dB. Refer to Figure 10-8.

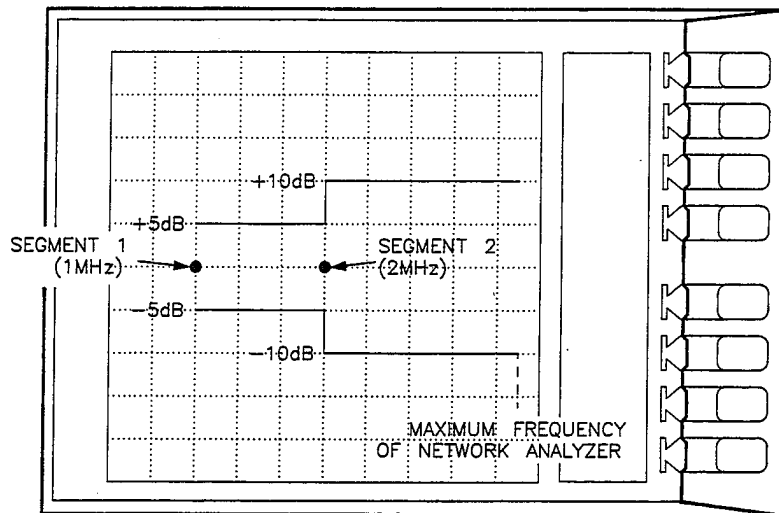

Figure 10-8. Flat Line Limit Type Example

Notice the second set of limit lines shown in Figure 10-8 (+10 dB and -10 dB). These limit lines start at 2 MHz (the frequency of segment 2) and continue until the maximum frequency of the instrument is reached. Maximum stimulus value (in this case frequency) is the default end point unless an end segment is specified. To terminate limit lines, the final segment must be set to the single point limit type, explained below.

- Sloping line – upper and lower limits change linearly from one segment to the next.

Example: Segment 1 is at 1 MHz and has an upper and lower limit of +5 and -5 dB, respectively. Segment 2 is at 2 MHz, and has an upper and lower limit of +10 and -10 dB. The upper limit will start out at segment 1's frequency (1 MHz) at a value of +5 dB. It will slope upwards, linearly, until it is equal to +10 dB at 2 MHz (segment 2's frequency). The same will occur on the lower limit. At 1.5 MHz, the upper and lower limits will be +7.5 and -7.5 dB, respectively.

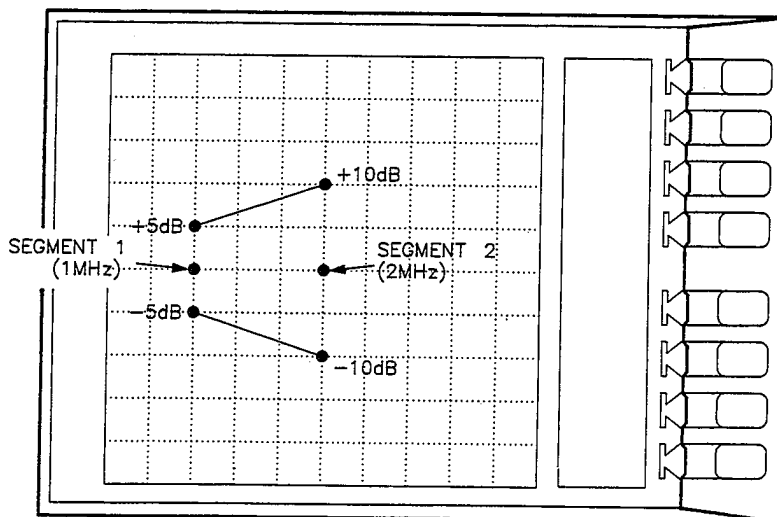

Figure 10-9. Sloping Line Limit Type Example

There is also a third limit type:

- Single point – DUT performance is checked only at the exact stimulus values of the stimulus points. The limits do not apply between the segments. This type of segment can terminate limit lines (so they will not continue up to the maximum stimulus value of the analyzer).

Each segment can have a different limit type.

Limits can be defined independently for the two channels. These can be in any combination of the three limit types.

### **Turning Limit Lines and Limit Testing On and Off**

Limit lines and limit testing features are off unless explicitly turned on by the user. After entering limit line information you may turn on limit lines and (optionally) limit testing features. Turning these features off has no effect on the entered limit line information.

### **Limit Lines Do Not Need to Be Entered in Order**

The limit segments do not have to be entered in any particular order: the HP 8752 automatically sorts them and lists them on the display in increasing order of stimulus value.

For example: The first segment is set to a frequency stimulus value of 5 MHz, the second is set to 10 MHz. If you add the third segment at 7 MHz, the three segments will be automatically rearranged as follows:

Segment 1 5 MHz  
Segment 2 7 MHz  
Segment 3 10 MHz

### **Saving the Limit Line Table**

Limit line information is lost if you press [PRESET] or turn off the power switch. However, the [SAVE] and [RECALL] keys can save limit line information along with all other current instrument settings. This "instrument state" information can be saved to non-volatile memory or to an optional disk drive.

### **Offsetting the Stimulus or Amplitude Values of the Limit Lines**

All limit line entries can be offset in either stimulus or amplitude value. The offset affects all segments simultaneously.

### **Supported Display Formats**

Limit lines are displayed only on Cartesian formats (LOG MAG, PHASE, DELAY, SWR, LIN MAG). In polar and Smith chart formats, limit testing of one value is available: the value tested depends on the marker mode and is the magnitude or the first value in a complex pair. The message "NO LIMIT LINES DISPLAYED" is shown on the display in polar and Smith formats.

### **Use a Sufficient [NUMBER of POINTS] or Errors May Occur**

Limits are checked only at the actual measured data points. It is possible for a device to be out of specification without a limit test failure indication if you do not select a sufficient [NUMBER of POINTS].



## Displaying, Printing, or Plotting Limit Test Data

The "list values" feature in the copy menu prints or displays a table of each measured stimulus value. The table includes limit line and/or limit test information (if these functions are turned on). If limit testing is on, an asterisk \* is listed next to any measured value that is out of limits.

If limit lines are on, and other listed data allows sufficient space, the following will also be displayed:

- Upper limit and lower limit.
- The margin by which the device passes or fails the nearest limit.

For more information about the list values feature, refer to the descriptions behind the Printing and Plotting tab.

## Results of Plotting or Printing the Display with Limit Lines On.

If limit lines are on, they are shown when you print or plot the display. If limit testing is on, the PASS or FAIL message is included as well.

## Example of Use

An example of a measurement using limit lines and limit testing is provided in the *User's Guide*. Examples of use are also provided in the softkey menu descriptions below.

Example: Pressing the following keys creates a segment at 5 MHz, with an upper limit of 0 dB and a lower limit of -10 dB. It also selects a flat line limit type.

Entering the segment and parameters:

Action	Result
Press:	
[SYSTEM]	
[LIMIT MENU]	
[EDIT LIMIT LINE]	
[ADD]	
[STIMULUS VALUE] [5] [M/μ]	Places a segment at 5 MHz.
[UPPER LIMIT] [0] [x1]	Sets upper limit to 0 dB.
[LOWER LIMIT] [-] [1] [0] [x1]	Sets lower limit to -10 dB.
[DONE]	Finalizes the above selections.
[LIMIT TYPE] [FLAT LINE] [RETURN]	Sets limit type to flat line and returns to the last menu.

Repeat this for each limit segment needed. If you are using the flat line limit type, the last segment does not require limit values. Segments are automatically arranged in the list by stimulus value.

Next, perform the following:

Action	Result
Press:	
[DONE]	
[LIMIT LINE on OFF]	Places limit lines on the display.
[LIMIT TEST on OFF]	Turns on limit testing

## LIMITS MENU

This menu independently toggles the limit lines, limit testing, and limit fail beeper. It also leads to menus that define and modify the limits.

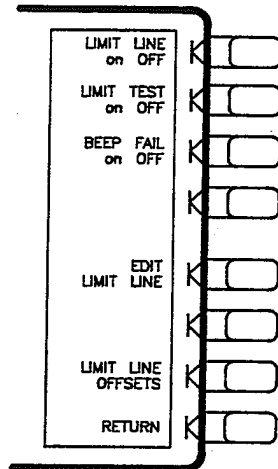

Figure 10-10. Limits Menu

### Creating New Limit Line Definitions

**[EDIT LIMIT LINE]** (EDITLIML) displays a table of limit segments on the display. The edit limits menu is presented so that limits can be defined or changed. It is not necessary for limit lines or limit testing to be on while limits are defined.

### Turning Limit Lines On and Off

**[LIMIT LINE on OFF]** (LIMILINEON, LIMILINEOFF) turns limit lines on or off. To define limits, use the **[EDIT LIMIT LINE]** softkey described above. If limits have been defined and limit lines are turned on, the limit lines are displayed on the display (in all Cartesian display formats: LOG MAG, PHASE, DELAY, SWR, LIN MAG).

**[LIMIT TEST on OFF]** (LIMITESTON, LIMITESTOFF) turns limit testing on or off. When limit testing is on, the data is compared with the defined limits at each measured point. Limit tests occur at the end of each sweep, whenever the data is updated, when formatted data is changed, and when limit testing is first turned on.

Limit testing is available for both magnitude and phase values in Cartesian formats. In polar and Smith chart formats, the value tested depends on the marker mode and is the magnitude or the first value in a complex pair. The message "NO LIMIT LINES DISPLAYED" is displayed in polar and Smith formats if limit lines are turned on.

### Turning Beep Fail Off

**[BEEP FAIL on OFF]** (BEEPFAILON, BEEPFAILOFF) turns the limit fail beeper on or off. When limit testing is on and the fail beeper is on, a beep is sounded each time a limit test is performed and a failure detected. The limit fail beeper is independent of the warning beeper and the operation complete beeper.

## Offsetting the Stimulus or Amplitude Settings

[**LIMIT LINE OFFSETS**] leads to the offset limits menu, described later in this tab section. This feature can offset all stimulus or amplitude values by a selected amount.

## Menu Control

[**RETURN**] goes back to the system menu.

## EDIT LIMITS MENU

This menu is summoned when you press the [**EDIT LIMIT LINE**] softkey. The edit limits menu allows you to add new segments or select existing segments to be edited. The [**ADD**] and [**EDIT**] softkeys in this menu summon the edit segment menu (described later), which lets you select stimulus and limit values.

A table of limit values appears on the display when this menu is summoned. A thorough description of how limit segments work is provided at the beginning of this tab section. You should read that information before continuing.

For each segment, the table shows the segment number, stimulus value, upper limit, lower limit, and limit type. Limit values can be entered as upper and lower limits or as delta limits with a middle value.

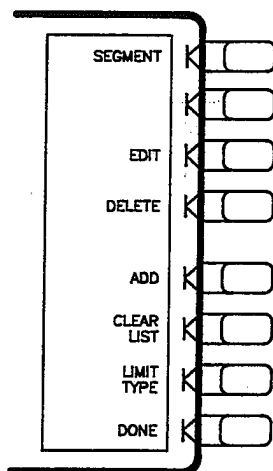

Figure 10-11. Edit Limits Menu

## Adding a New Segment

[**ADD**] (SADD) Pressing this key adds a new segment to the displayed list. It then summons the edit segment menu (which allows you to enter the desired stimulus and limit values).

[**LIMIT TYPE**] leads to the limit type menu, where one of three segment types can be selected.

[**DONE**] (EDITDONE) sorts the limit segments and displays them in increasing order (of stimulus value) and returns to the previous menu.

## Segment Editing Softkeys

**[SEGMENT]** This key allows you to select an existing segment entry so it can be edited. Pressing **[SEGMENT]** allows you to scroll the list up or down to show other segment entries. Use the entry block controls to place the pointer > next to the segment to be edited (the list moves, the pointer remains stationary).

**[EDIT]** (SEDI) To edit an existing segment, first select it using the **[SEGMENT]** softkey (explained above), then press **[EDIT]**. The instrument will present the edit segment menu, which is explained below.

**[DELETE]** (SDEL) deletes the segment indicated by the pointer >.

**[CLEAR LIST]** (CLEL) Clears all of the segments in the limit test.

## EDIT SEGMENT MENU

This menu is summoned by pressing either the **[ADD]** or **[EDIT]** softkeys in the previous menu. This menu lets you select stimulus and limits values.

The stimulus value can be set with the controls in the entry block or with a marker (a marker is turned on automatically when this menu appears). The limit values can be defined as upper and lower limits, or delta limits with a middle value.

If you select a lower limit, an upper limit must also be selected. The reverse of this is also true. If you only need the upper or lower limit for a particular measurement, force the other out of range (for example, enter +500 dB or -500 dB for the unwanted limit).

As new values are entered, the tabular listing of limit values is updated.

Phase limit values can be specified between +500° and -500°. Limit values above +180° and below -180° are mapped into the range of +180° to -180° to correspond with the range of phase data values.

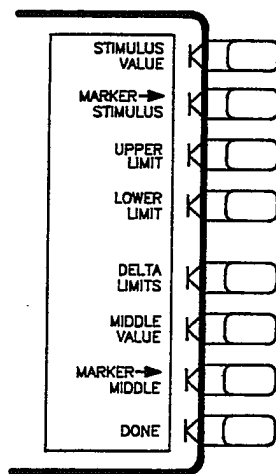

Figure 10-12. Edit Segment Menu

## Setting Stimulus Value

**NOTE:** Stimulus refers to the selected units shown on the x-axis of the display, in other words, frequency in frequency sweep mode, power in power sweep mode, and so on.

Stimulus value can be set with **[STIMULUS VALUE]** or **[MARKER → STIMULUS]** softkeys.

**[STIMULUS VALUE]** (LIMS) sets the stimulus value of a segment, using entry block controls.

**[MARKER → STIMULUS]** (MARKSTIM) sets the stimulus value of a segment using the active marker. Move the marker to the desired stimulus value before pressing this key, and the marker stimulus value will be entered as the segment stimulus value.

## Setting Limit Values

Use one of two methods for setting limit values:

- Set upper and lower limits using **[UPPER LIMIT]** and **[LOWER LIMIT]** softkeys.
- Set a center value using **[MARKER → MIDDLE]** or **[MIDDLE VALUE]** softkeys, then press **[DELTA LIMITS]** and enter the acceptable  $\pm$  tolerance.

**[UPPER LIMIT]** (LIMU) sets the upper limit value for the segment.

When **[UPPER LIMIT]** or **[LOWER LIMIT]** is pressed, all the segments in the table are displayed in terms of upper and lower limits, even if they were defined as delta limits and middle value.

If you attempt to set an upper limit that is lower than the lower limit (or the reverse of this action), both limits will be automatically set to the same value.

**[LOWER LIMIT]** (LIML) sets the lower limit value for the segment.

**[MIDDLE VALUE]** (LIMM) sets the midpoint for **[DELTA LIMITS]**. It uses the entry controls to set a specified amplitude value vertically centered between the limits.

**[MARKER → MIDDLE]** (MARKMIDD) sets the midpoint for **[DELTA LIMITS]** using the active marker to set the middle amplitude value of a limit segment. Move the marker to the desired value or device specification, and press this key to make that value the midpoint of the delta limits. The limits are automatically set an equal amount above and below the marker.

**[DELTA LIMITS]** (LIMD) sets the limits an equal amount above and below a specified middle value, instead of setting upper and lower limits separately. This is used in conjunction with **[MIDDLE VALUE]** or **[MARKER → MIDDLE]**, to set limits for testing a device that is specified at a particular value plus or minus an equal tolerance.

For example, a device may be specified to output  $-5 \text{ dB} \pm 3 \text{ dB}$ . Enter the middle value as  $-5 \text{ dB}$  and the delta limits as  $3 \text{ dB}$ .

When **[DELTA LIMITS]** or **[MIDDLE VALUE]** is pressed, all the segments in the table are displayed in these terms, even if they were defined as upper and lower limits.

## Making an Entry or Correction Final

**[DONE]** (SDON) terminates a limit segment definition, and returns to the edit limits menu.

## LIMIT TYPE MENU

The limits you specify can be implemented in three ways. The three limit types are:

- Flat line – The limits stay the same from one segment to the next. The change in limits from one segment to the next will occur instantly, in a distinct step.

Example: Segment 1 is at 1 MHz and has an upper and lower limit of +5 and –5 dB, respectively. Segment 2 is at 2 MHz, and has an upper and lower limit of +10 and –10 dB. Segment 1's limits (+5 and –5 dB) will apply, unchanged, up to 2 MHz, at which time they instantly change to +10 and –10 dB.

- Sloping line – upper and lower limits change linearly from one segment to the next.

Example: Segment 1 is at 1 MHz and has an upper and lower limit of +5 and –5 dB, respectively. Segment 2 is at 2 MHz, and has an upper and lower limit of +10 and –10 dB. The upper limit will start out at segment 1's frequency (1 MHz) at a value of +5 dB. It will slope upwards, linearly, until it is equal to +10 dB at 2 MHz (segment 2's frequency). The same will occur on the lower limit. At 1.5 MHz, the upper and lower limits will be +7.5 and –7.5 dB, respectively.

- Single point – upper and lower limits are checked only at specified stimulus points. The limits do not apply between the segments. This limit type will terminate limit lines (so they do not continue to the maximum stimulus value of the analyzer).

Each segment can have a different limit type.

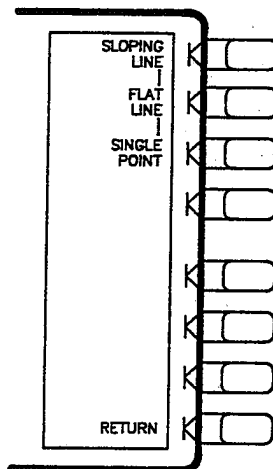

Figure 10-13. Limit Type Menu

**[SLOPING LINE]** (LIMTSL) See the description above. A sloping line segment is indicated as "SL" on the displayed table of limits.

**[FLAT LINE]** (LIMTFL) See the description above. A flat line segment is indicated as FL on the table of limits.

**[SINGLE POINT]** (LIMTSP) see the description above. If limit lines are on, the upper limit value of a single point limit is displayed as  $\nabla$ , and the lower limit is displayed as  $\wedge$ . A limit test at a single point tests the nearest actual measured data point.

A single point limit can be used as a termination for a flat line or sloping line limit segment. When a single point terminates a sloping line or when it terminates a flat line and has the same limit values as the flat line, the single point is not displayed as  $\nabla$  and  $\wedge$ . The indication for a sloping line segment in the displayed table of limits is SP.

## **Menu Control**

**[RETURN]** goes back to the edit limits menu.

## OFFSET LIMITS MENU

This menu allows all segments to be offset in either stimulus value or amplitude value. This is useful for changing the limits to correspond with a change in the test setup (for example, adding or removing an attenuator), or for testing devices with different stimulus or amplitude specifications.

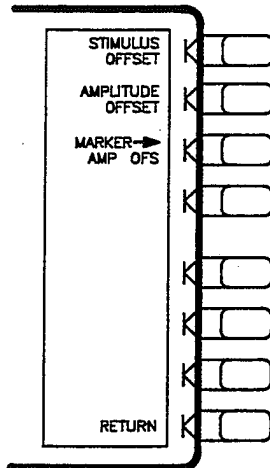

Figure 10-14. Offset Limits Menu

**[STIMULUS OFFSET]** (LIMISTIO) adds or subtracts an offset in stimulus value. This allows limits already defined to be used for testing in a different stimulus range. Use the entry block controls to specify the offset required.

Example: A set of limit lines begins at 10 MHz and ends at 20 MHz. Pressing **[STIMULUS OFFSET]** **[100]** **[M/μ]** would offset the limit lines by +100 MHz. The stimulus value of each segment in the set would have 100 MHz added to it. The result would be a set of limit lines starting at 110 MHz and ending at 120 MHz.

**[AMPLITUDE OFFSET]** (LIMIAMPO) adds or subtracts an offset in amplitude value. This allows previously defined limits to be used at a different power level. For example, if attenuation is added to or removed from a test setup, the limits can be offset an equal amount.

**[MARKER → AMP. OFS.]** (LIMIMAOF) uses the active marker to set the amplitude offset. Move the marker to the desired middle value and press this softkey. The limits are then moved so they are centered an equal amount above and below the marker at that stimulus value.

**[RETURN]** goes back to the limits menu.



# TEST SEQUENCING

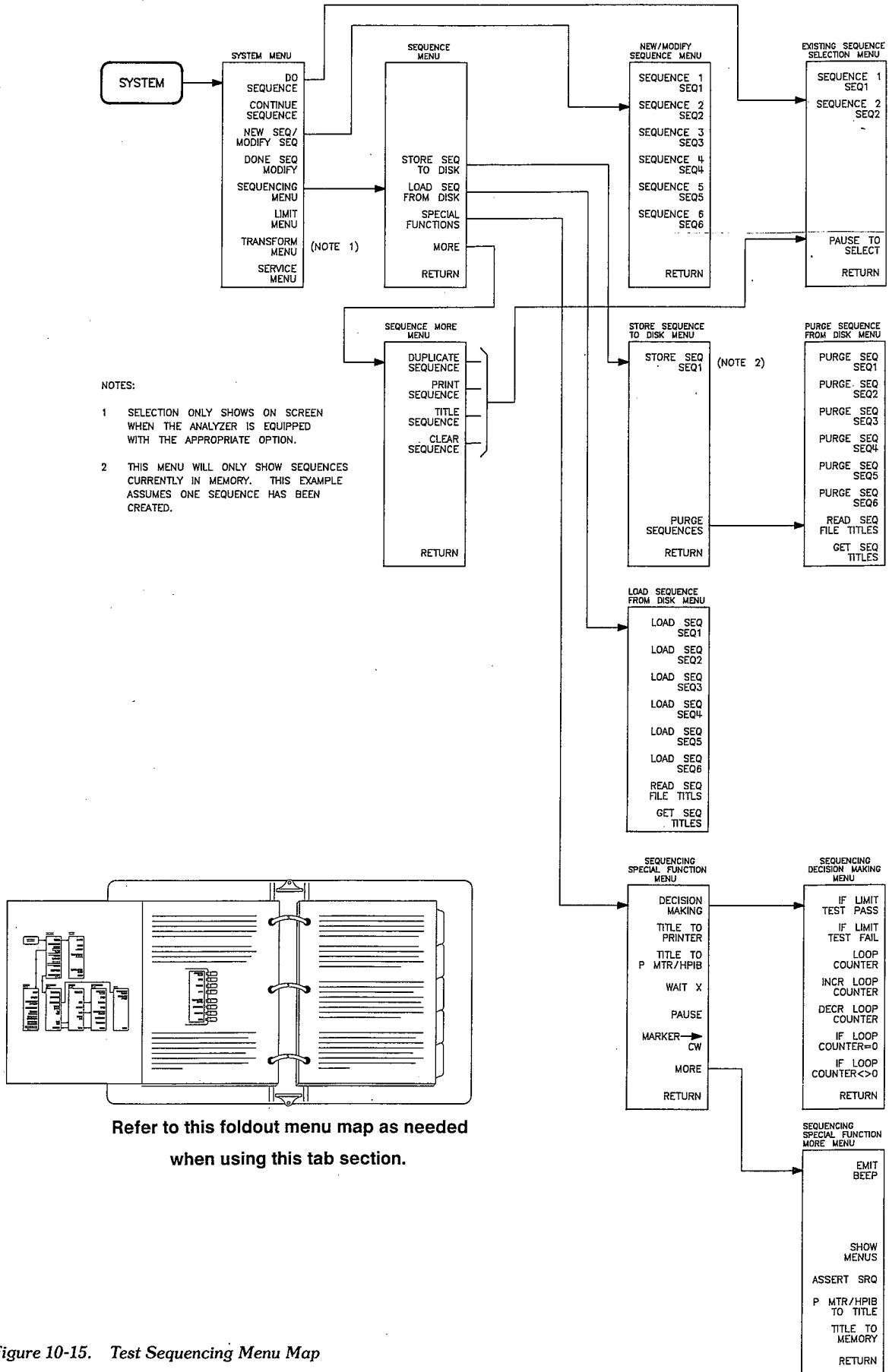

Figure 10-15. Test Sequencing Menu Map

# Test Sequencing

## CONTENTS

10-25	Introduction
10-25	What is Test Sequencing?
10-26	System Key Menu
10-27	Existing Sequence Selection Menu
10-28	Sequence Menu
10-29	New/Modify Sequence Menu
10-30	Store Sequence to Disk Menu
10-31	Load Sequence from Disk Menu
10-32	Purge Sequence from Disk Menu
10-33	Sequence More Menu
10-34	Sequencing Special Functions
10-35	Important Concepts
10-35	Autostarting Sequences
10-36	Sequencing Special Function Menu
10-37	Sequencing Decision Making Menu
10-38	Sequencing Special Function More Menu
10-40	HP-GL Considerations
10-41	Entering Sequences Using HP-IB
10-41	Reading Sequences Using HP-IB
10-41	Decision-Making Example Sequences

## INTRODUCTION

The test sequence function is accessed by pressing the **[SYSTEM]** key. The *User's Guide* explains how to create, edit, run, store, name, and print test sequences. This tutorial information is not repeated here.

This section contains:

- Detailed menu and softkey descriptions.
- Tutorial information on advanced sequencing features.

## WHAT IS TEST SEQUENCING?

Test sequencing automates repetitive tasks. In sequencing mode you make the measurement once and the network analyzer memorizes the keystrokes. Later the entire sequence can be repeated by pressing a single key. Because the sequence is defined with normal measurement keystrokes, no additional programming expertise is required. Limited decision-making increases the flexibility of test sequences.

The test sequence function allows the user to create, title, save, and execute up to six independent sequences internally. Test sequences can dramatically reduce the time required to make a multiple step measurement, and can greatly reduce operator errors. Sequences may be saved to external disk and can be transferred between the network analyzer and an external computer controller.

## SYSTEM KEY MENU

**[SYSTEM] KEY** (MENSYST). Pressing this key presents the system menu. This menu is shown in the upper-left corner of (fold-out) Figure 10-15.

The first four softkeys in this menu are devoted to commonly used test sequencing functions. The common sequencing tasks are: running a sequence (DO SEQUENCE), continuing a paused sequence, creating/editing a sequence, and ending the creation/editing process (DONE SEQ MODIFY).

**[DO SEQUENCE]** (DOSEQn) has two functions:

- It shows the “existing sequence selection menu”, which shows the names of current sequences residing in memory. To run one of them, press the softkey next to the appropriate sequence name.
- When entered into a sequence, this command performs a one-way jump to another sequence.

**[CONTINUE SEQUENCE]** resumes sequence operation. A sequence will pause during execution if it encounters the sequencing PAUSE command. This allows the operator to change test setup or insert a new device under test. The user is prompted to press this key to continue sequence operation.

**[NEW SEQ/MODIFY SEQ]** (NEWSEQn) activates the edit mode and presents the new/modify sequence menu with a list of sequences that can be created or modified.

**[DONE SEQ MODIFY]** (DONM) terminates the edit mode.

**[SEQUENCING MENU]** leads to the sequence menu (described below), where lesser-used functions are accessed, including:

- Disk utilities such as saving, loading, viewing and deleting sequence files on disk. Also, clearing sequences from memory.
- General functions such as naming, printing and clearing sequences.
- Advanced sequence functions including: Decisions based on limit testing or the value of a loop counter, pause, wait, beep, and others.

**[LIMIT MENU]** refer to the limit lines section for information.

**[TRANSFORM MENU]** refer to the time domain section for information.

**[SERVICE MENU]** refer to the *Service Manual* for information.

## EXISTING-SEQUENCE SELECTION MENU

This menu is displayed when any of the following sequencing commands are executed:

- Do Sequence
- Duplicate Sequence
- Print Sequence
- Title Sequence
- Clear Sequence

As the name implies, this menu only shows the names of sequences that actually exist in instrument memory.

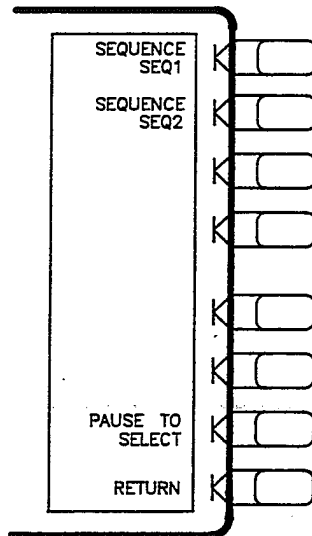

Figure 10-16. Existing-Sequence Selection Menu

**[SEQUENCE 1 SEQ1]** and **[SEQUENCE 2 SEQ2]** are example sequences. This menu will actually show only those sequences you have created or loaded into memory.

**[PAUSE TO SELECT]** (PTOS) This command only functions when placed inside a sequence. When run, the sequence will proceed normally until the **[PAUSE TO SELECT]** command is encountered. The sequence then pauses, and presents the “existing-sequence selection menu”, allowing the operator to run any available sequence. This command only shows up in the “existing sequence menu”.

Example of use: Several types of devices are tested on a single instrument, and much of the initial instrument setup is the same. In this example, several sequences have been created. The first sequence sets up all common measurement parameters, the rest of the sequences test specific device types.

For example:

**[SEQUENCE 1 SETUP]** – Performs initial (common) measurement setup.

**[SEQUENCE 2 FILTER]** – Measures a filter.

**[SEQUENCE 3 SAW]** – Measures a SAW device.

**[SEQUENCE 4 ATTEN]** – Measures an attenuator.

When creating the first sequence, perform the initial measurement setup commands and press **[SYSTEM] [DO SEQUENCE] [PAUSE AND SELECT] [RETURN] [DONE SEQ MODIFY]**.

When the operator runs the SETUP sequence, the common measurement commands are performed and the "existing-sequence selection menu" is displayed.

Pressing the softkey next to **[SEQUENCE 2 FILTER]** runs that particular sequence. Choosing one of the displayed sequences is not mandatory, any other instrument keys or softkeys can be pressed.

**[RETURN]** Returns to the system menu.

## SEQUENCE MENU

Figure 10-17 shows the commands available in the sequence menu.

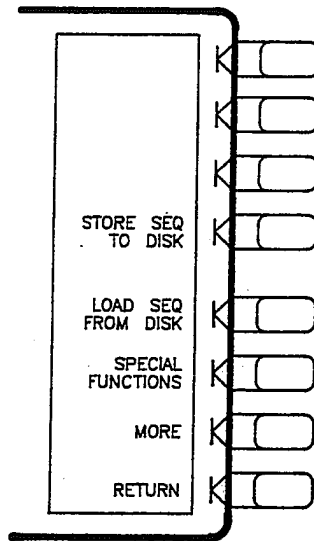

Figure 10-17. Sequence Menu

**[STORE SEQ TO DISK]** (STORSEQn) presents the store sequence to disk menu with a list of sequences that can be stored.

**[LOAD SEQ FROM DISK]** (LOADSEQn) presents the load sequence from disk menu. Select the desired sequence and the network analyzer will load it from disk.

**[SPECIAL FUNCTIONS]** presents the special function menu. Features include:

- Jump to a sequence (use the **[DO SEQUENCE]** key in the sequence).
- Limit test decision (**[IF LIMIT TEST PASS]**, **[IF LIMIT TEST FAIL]**).
- Loop counter value manipulation (increment/decrement, set value).
- Loop counter decision (**[IF COUNTER = 0]**, **[IF COUNTER <> 0]**).
- Send command to printer (**[TITLE TO PRINTER]** includes a line feed).
- Send command to HP-IB device (**[TITLE TO P MTR/HPIB]**).
- Wait.
- Pause.
- Set CW stimulus frequency to frequency of active marker (**[MARKER → CW]**).
- Emit beep.
- Assert SRQ.
- Output specified binary (TTL) number to rear panel "test set interconnect" connector.
- Show menu to operator/show menu in sequence listing (**[SHOW MENUS]**).
- Read data from HP-IB device (**[P MTR/HPIB TO TITLE]** followed by **[TITLE TO MEMORY]**).
- Move data to data array memory (**[TITLE TO MEMORY]**).

**[MORE]** presents the sequence more menu.

**[RETURN]** returns to the system menu.

## NEW/MODIFY SEQUENCE MENU

Procedures for creating and editing sequences are provided in the *User's Guide*. Figure 10-18 shows this menu: Use this to select the sequence to be created or modified. Sequences in positions 1 through 5 are stored in volatile memory and are erased if line power is turned off. Sequence position 6 is stored in non-volatile memory and will survive if line power is turned off.

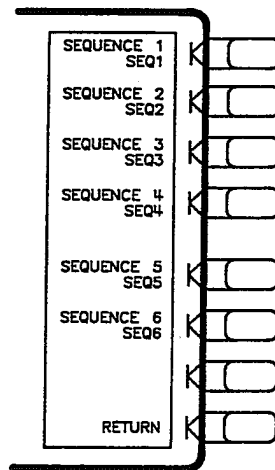

Figure 10-18. New/Modify Sequence Menu

## Description of the Menu Selections

Format of softkey label: **[SEQUENCE X SEQX]**. X is a number from 1 to 6. "SEQUENCE X" is the position of the sequence, "SEQX" is the default sequence title. Sequence titles can be changed, refer to the *User's Guide* for instructions. The following is a list of the actual softkey labels and their HP-IB code equivalents:

**[SEQUENCE 1 SEQ1]** (NEWSEQ1)  
**[SEQUENCE 2 SEQ2]** (NEWSEQ2)  
**[SEQUENCE 3 SEQ3]** (NEWSEQ3)  
**[SEQUENCE 4 SEQ4]** (NEWSEQ4)  
**[SEQUENCE 5 SEQ5]** (NEWSEQ5)  
**[SEQUENCE 6 SEQ6]** (NEWSEQ6)  
**[RETURN]** returns to the sequence menu

## STORE SEQUENCE TO DISK MENU

A procedure for storing a sequence to disk is provided in the *User's Guide*. Figure 10-19 shows the commands available in this menu. Select the desired sequence and the network analyzer will store it to a compatible disk drive.

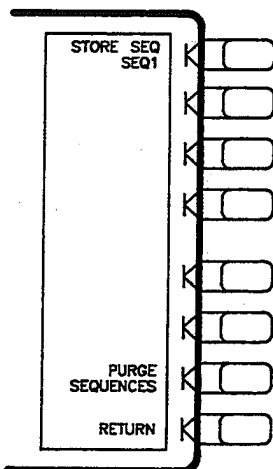

Figure 10-19. Store Sequence to Disk menu

The store sequence to disk menu shows only the titles of sequences currently in memory. Figure 10-19 is an example menu showing a single sequence in memory. Storing to disk requires a CS-80 compatible HP-IB disk drive such as the HP 9122. The network analyzer must be in system controller mode.

**[STORE SEQ SEQ1]** (STORSEQ1) the sequence "SEQ1" is in memory. Pressing this softkey will store "SEQ1" to the disk.

**[PURGE SEQUENCES]** presents the purge sequence from disk menu.

**[RETURN]** returns to the sequence menu.

## LOAD SEQUENCE FROM DISK MENU

Loading a sequence from disk is explained in the *User's Guide*. Use this menu to select the desired sequence and the network analyzer will load it from disk.

This menu shows default sequence names unless:

1. The operator has changed one or more of the titles, or...
2. A sequence with a different title has been loaded.

In these cases, the softkey labels will show any 8-character title the operator has entered. (Many times it's easier to load a file from disk by changing one of the softkey labels to match the name of the desired sequence. This saves time when there are many sequences on the disk because the disk directory command (**[READ SEQ FILE TITLS]**) can only show six names at a time.)

Figure 10-20 shows the load sequence from disk menu.

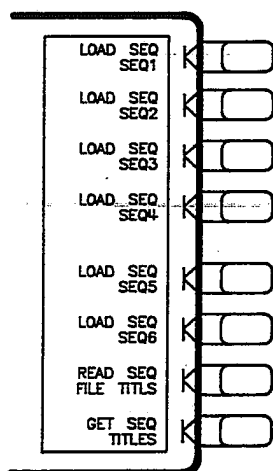

Figure 10-20. Load Sequence from Disk Menu

### Description of the Menu Selections

Format of softkey labels: **[LOAD SEQ SEQX]**. X is a number from 1 to 6. "SEQ X" is the name of the sequence to be loaded from disk. The following is a list of the actual softkey labels and their HP-IB code equivalents:

- [LOAD SEQ SEQ1]** (LOADSEQ1)
- [LOAD SEQ SEQ2]** (LOADSEQ2)
- [LOAD SEQ SEQ3]** (LOADSEQ3)
- [LOAD SEQ SEQ4]** (LOADSEQ4)
- [LOAD SEQ SEQ5]** (LOADSEQ5)
- [LOAD SEQ SEQ6]** (LOADSEQ6)



**[READ SEQ FILE TITLS]** is a disk file directory command. Pressing this softkey will read the first six sequence titles and display them in the softkey labels.

If **[READ SEQ FILE TITLS]** is pressed a second time, the next six sequence titles on the disk will be displayed. To read the contents of the disk starting again with the first sequence: remove the disk, reinsert it, and press **[READ SEQ FILE TITLS]**. When you press this key, the sequence names that are currently loaded into the instrument will be replaced by the names of sequences on the disk. To get the original sequence names to reappear, press **[GET SEQ TITLES]**.

**[GET SEQ TITLES]** Brings back the names of the sequences that are actually in instrument memory (ready to be executed). See the **[READ SEQ FILE TITLES]** description, above.

## PURGE SEQUENCE FROM DISK MENU

A procedure for purging a sequence from disk is provided in the *User's Guide*. Use this menu to select the sequence to be purged from disk. This menu shows default sequence names unless:

1. The operator has changed one or more of the titles, or...
2. A sequence with a different title has been loaded.

In these cases, the softkey labels will show any 8-character title the operator has entered. (Many times it's easier to purge a file from disk by changing one of the softkey labels to match the name of the undesired sequence. This saves time when there are many sequences on the disk, because the disk directory command (**[READ SEQ FILE TITLS]**) can only show six names at a time.)

Figure 10-21 shows the purge sequence from disk menu.

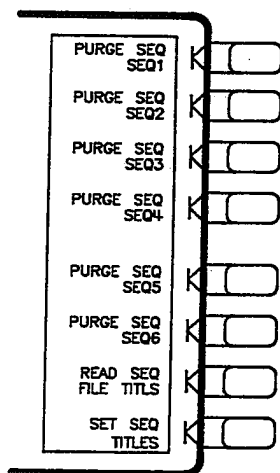

Figure 10-21. Purge Sequence from Disk Menu

[PURGE SEQ SEQ1] through [PURGE SEQ SEQ6] purges the indicated sequence from disk.

[READ SEQ FILE TITLS] is a disk file directory command. Pressing this softkey will read the first six sequence titles and display them in the softkey labels.

If [READ SEQ FILE TITLS] is pressed a second time, the next six sequence titles on the disk will be displayed. To read the contents of the disk starting again with the first sequence: remove the disk, reinsert it, and press [READ SEQ FILE TITLS]. When you press this key, the sequence names that are currently loaded into the instrument will be replaced by the names of sequences on the disk. To get the original sequence names to reappear, press [GET SEQ TITLES].

[GET SEQ TITLES] Brings back the names of the sequences that are actually in instrument memory (ready to be executed). See the [READ SEQ FILE TITLES] description, above.

## SEQUENCE MORE MENU

Figure 10-22 shows the commands available in the sequence more menu.

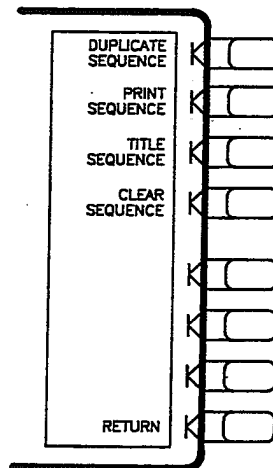

Figure 10-22. Sequence More Menu

[DUPLICATE SEQUENCE] (DUPLSEQxSEQy) duplicates a sequence currently in memory into a different softkey position. Duplicating a sequence is straightforward. Follow the prompts on the network analyzer screen. This command does not affect the original sequence.

[PRINT SEQUENCE] (PRINSEQn) prints any sequence currently in memory to a compatible printer. Refer to "Accessories Available" in the "General Information" section for a list of compatible printers. A procedure for printing a sequence is provided in the *User's Guide*.

[TITLE SEQUENCE] (TITSEQn) allows the operator to rename any sequence with an eight character title. All titles entered from the front panel must begin with a letter, and may only contain letters and numbers. A procedure for changing the title of a sequence is provided in the *User's Guide*.

**[CLEAR SEQUENCE]** (CLEASEn) clears a sequence from memory. The titles of cleared sequences will remain in load, store, and purge menus. This is done as a convenience for those who often reuse the same titles. A procedure for clearing a sequence is provided in the *User's Guide*.

**[RETURN]** returns to the sequence menu.

## SEQUENCING SPECIAL FUNCTIONS

The purposes of some special functions are not obvious from the softkey label. Figure 10-23 shows all special function menus.

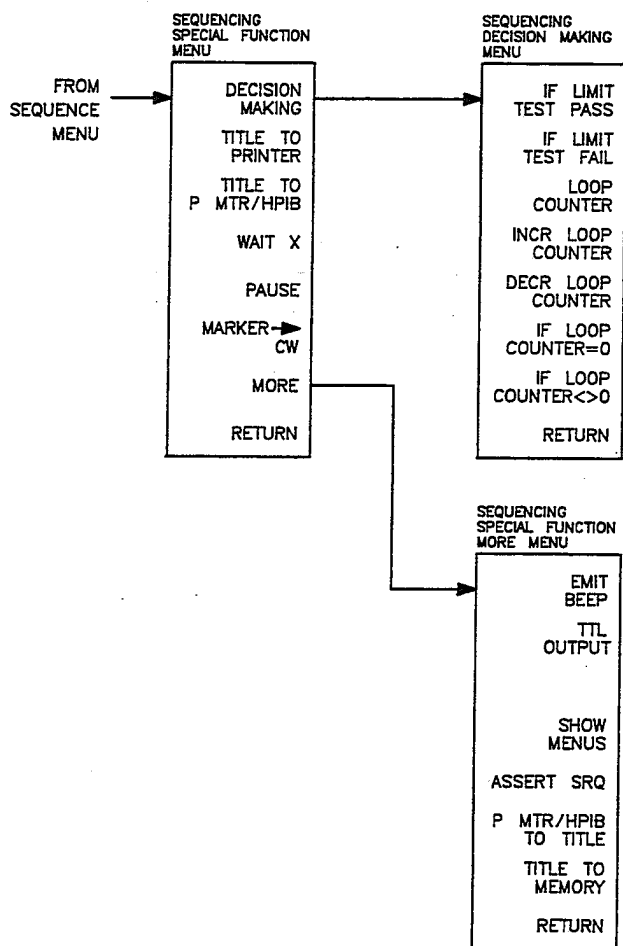

Figure 10-23. Sequencing Special Function Menus

## Important Concepts

Some concepts presented in this chapter require explanation. Key concepts are explained below:

**Sequence Title and Sequence Position.** There are two attributes to any sequence. Each sequence has a title, and exists in one of the six sequence softkey positions. Softkey positions are referred to as SEQUENCE 1 through SEQUENCE 6, with position 1 at the top.

**Decision Making Functions.** Decision making functions are explained in more detail below. These functions check a condition and jump to a specified sequence if the condition is true. The sequence called must be in memory. A sequence call is a one-way jump; there is no equivalent of computer subroutines in sequencing. A sequence can jump to itself, or to any of the other five sequences currently in memory. Use of these features is explained under the specific softkey descriptions.

**Decision making functions jump to a softkey location, not to a specific sequence title!** Limit test, loop counter, and do sequence commands jump to any sequence residing in the specified sequence position (SEQUENCE 1 through 6). These commands do not jump to a specific sequence title. Whatever sequence is in the selected softkey position will run when these commands are executed. Thus it is important to have needed sequences loaded into the same positions as originally created.

**Having a Sequence Jump to Itself.** A decision making command can jump to the sequence it resides in. When this occurs, the sequence starts over and all commands in the sequence are repeated. This is used a great deal in conjunction with loop counter commands. See the loop counter description below.

**Limit Test Decision Making.** A sequence can jump to another sequence or start over depending on the result of a limit test. When entered into a sequence, the **[IF LIMIT TEST PASS]** and **[IF LIMIT TEST FAIL]** commands require the operator to enter the destination sequence position.

**Loop Counter/Loop Counter Decision Making.** The network analyzer has a numeric register called a loop counter. The value of this register can be set by a sequence, and it can be incremented or decremented each time a sequence repeats itself. This is best done using two sequences. The first sets the counter value, and the second performs the iterative loop.

The decision making commands **[IF LOOP COUNTER = 0]** and **[IF LOOP COUNTER <>0]** jump to another sequence if the stated condition is true. When entered into the sequence, these commands require the operator to enter the destination sequence. Either command can jump to another sequence, or restart the current sequence. Restarting the current sequence is done by telling the sequence to jump to its own position.

For example: If the sequence is in position 1, you could use the following to jump back to the beginning of the same sequence:

```
[IF LOOP COUNTER <>0] (If loop counter value is not zero...)  
[SEQUENCE 1 SEQ1] (...Jump to sequence position 1.)
```

As explained later, the loop counter value can be appended to a title. This allows customized titles for data printouts or for data files saved to disk.

## Autostarting Sequences

A sequence can be defined that will run automatically when power is applied to the network analyzer. To make an autostarting sequence, create a sequence in position six and title it "AUTO". To stop an autostarting sequence, press **[LOCAL]**. To stop an autostarting sequence from engaging at power on, you must clear it from memory or rename it. Instructions for performing either task are provided in the *User's Guide*.

## SEQUENCING SPECIAL FUNCTION MENU

Figure 10-24 shows the commands available in this menu.

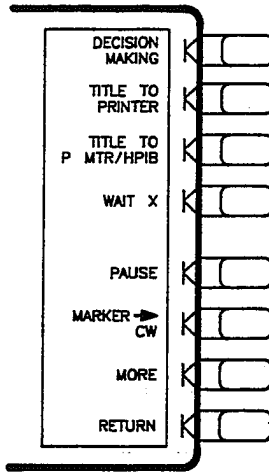

Figure 10-24. Sequencing Special Function Menu

**[DECISION MAKING]** presents the sequencing decision making menu.

**[TITLE TO PRINTER]** (TITTPRIN) outputs a title string to any device with an HP-IB address that matches the address set with the network analyzer's **[LOCAL]** **[SET ADDRESSES]** **[ADDRESS: PRINTER]** commands. This softkey is generally used for two purposes:

- Sending a title to a printer for data logging or documentation purposes.
- Sending commands to a printer or other HP-IB device.

When entering a sequence, create a display title and press **[TITLE TO PRINTER]**. When the sequence is run, the title will be sent to the printer. This command appends a carriage-return line feed (CR-LF) to the end of the string. The network analyzer must be in system controller or pass control mode.

To send a command to a printer or other HP-IB device, use the same procedure but enter the desired command as the title string.

**[TITLE TO P MTR/HPIB]** (TITTPMTR) outputs a title string to any device with an HP-IB address that matches the address set with the network analyzer's **[LOCAL]** **[SET ADDRESSES]** **[ADDRESS: P MTR/HPIB]** commands. This softkey is generally used for two purposes:

- Sending a title to a printer when a CR-LF is not desired.
- Sending commands to an HP-IB device.

When entering a sequence, create a display title containing a command or text string and press **[TITLE TO P MTR/HPIB]**. When the sequence is run, the string will be sent to the HP-IB device. The network analyzer must be in system controller or pass control mode.

**[WAIT X]** (SEQWAIT) pauses the execution of subsequent sequence commands for x number of seconds. Terminate this command with **[x1]**.

Entering a 0 in wait x causes the instrument to wait for prior sequence command activities to finish before allowing the next command to begin. The wait 0 command only affects the command immediately following it, and does not affect commands later in the sequence.

**[PAUSE]** (PAUS) pauses the sequence so the operator can perform a needed task, such as changing the DUT, changing the calibration standard, or other similar task. Press **[CONTINUE SEQUENCE]** when ready.

**[MARKER → CW]** (MARKCW) sets the CW frequency of the network analyzer to the frequency of the active marker.

**[MORE]** presents the sequencing special function more menu.

**[RETURN]** returns to the sequence menu.

## SEQUENCING DECISION MAKING MENU

Figure 10-25 shows the commands available in this menu.

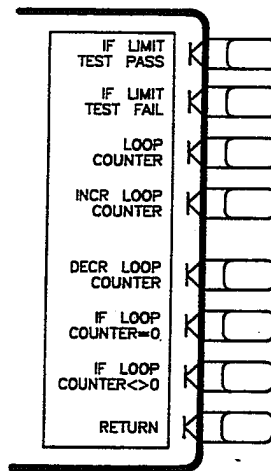

Figure 10-25. Sequencing Decision Making Menu

**Limit Test Commands.** Limit lines must be set up in the sequence before limit test pass/fail commands are performed. The limit test decision-making commands jump to a specified sequence if the conditions of the command are met.

**Decision-Making Sequence Examples.** Examples of limit test and loop counter sequences are provided at the end of this chapter.

**[IF LIMIT TEST PASS]** (IFLTPASS) jumps to one of the six sequence positions (SEQUENCE 1 through 6) if the limit test passes. This command executes any sequence residing in the selected position. Sequences may jump to themselves as well as to any of the other sequences in memory. When this softkey is pressed, the network analyzer presents a softkey menu showing the six sequence positions, and the titles of the sequences located in them. Choose the sequence to be called if the limit test passes (destination sequence).

**[IF LIMIT TEST FAIL]** (IFLTFAIL) jumps to one of the six sequence positions (SEQUENCE 1 through 6) if the limit test fails. In all other respects this key is identical to the **[IF LIMIT TEST PASS]** softkey.

**[LOOP COUNTER]** (LOOC) sets the value of the loop counter. Enter any number from 0 to 32767 and terminate with the **[x1]** key. The default value of the counter is zero. This command should be placed in a sequence that is separate from the looping measurement sequence. This keeps the counter value from being initialized each time the loop is performed.

**[INCR LOOP COUNTER]** (INCRLOOC) increments the value of the loop counter by 1.

**[DECR LOOP COUNTER]** (DECRLOOC) decrements the value of the loop counter by 1.

**[IF LOOP COUNTER = 0]** (IFLCEQZE) prompts the user to select a destination sequence position (SEQUENCE 1 through 6). When the value of the loop counter reaches zero, the sequence in the specified position will run.

**[IF LOOP COUNTER <> 0]** (IFLCNEZE) prompts the user to select a destination sequence position (SEQUENCE 1 through 6). When the value of the loop counter is no longer zero, the sequence in the specified position will run.

## SEQUENCING SPECIAL FUNCTION MORE MENU

Figure 10-26 shows the commands available in this menu.

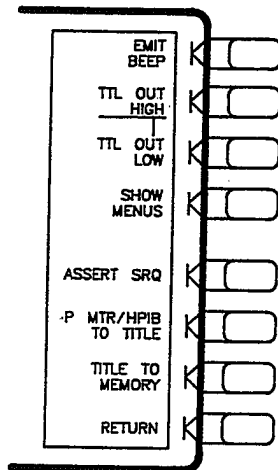

Figure 10-26. Sequencing Special Function More Menu

**[EMIT BEEP]** (EMIB) causes the instrument to beep once.

**[SHOW MENUS]** (SHOM)

When a sequence is created the analyzer displays a list of the commands you have entered. This "list" or "listing" is helpful when later examining a sequence. To conserve memory, the listing does not show the names of menus you pass through to get to a function, rather, it only shows the names of keys or softkeys you press which actually do something.

Here is an example: The left column shows the keys pressed, and the right column shows the resulting sequence listing.

<b>Keys Pressed</b>	<b>Sequence Listing</b>
<b>[LOCAL]</b>	
<b>[SYSTEM CONTROLLER]</b>	<b>SYSTEM CONTROLLER</b>

Notice that the sequence listing does not show how the SYSTEM CONTROLLER command was arrived at, only that it was entered.

Some users may want to have the intermediate steps show up in the sequence listing. This is the purpose of the **[SHOW MENUS]** softkey. When **[SHOW MENUS]** is pressed, all steps are shown in the listing.

For example:

<b>[LOCAL]</b>	<b>LOCAL</b>
<b>[SYSTEM CONTROLLER]</b>	<b>SYSTEM CONTROLLER</b>

However, this feature only remains active until a key is pressed that performs a function. For example, when the SYSTEM CONTROLLER command was entered above, **[SHOW MENUS]** mode was deactivated.

**[ASSERT SRQ]** (ASSS) sends an SRQ (service request) to the system controller.

**[P MTR/HPIB TO TITLE]** (PMTRTTIT) gets data from an HP-IB device set to the address at which the network analyzer expects to find a power meter. The data is stored in a title string. The network analyzer must be in system controller or pass control mode.

The external device should be given an interrogation command with the **[TITLE TO P MTR/HPIB]** or **[TITLE TO PRINTER]** command. When **[P MTR/HPIB TO TITLE]** is sent, the network analyzer will wait indefinitely (or until **[LOCAL]** is pressed) for a string of up to 80 characters. The network analyzer expects an EOI or line feed as a string terminator. This command can be used in conjunction with **[TITLE TO MEMORY]**, below.



**[TITLE TO MEMORY]** (TITMEM) moves the title string data obtained with the **[P MTR/HPIB TO TITLE]** command into a data array. **[TITLE TO MEMORY]** strips off leading characters that are not numeric, reads the numeric value, and then discards everything else. The number is converted into network analyzer internal format, and is placed into the real portion of the memory trace at:

$$\text{Display point} = \text{total points} - 1 - \text{loop counter}$$

If the value of the loop counter is zero, then the title number goes in the last point of memory. If the loop counter is greater than or equal to the current number of measurement points, the number is placed in the first point of memory. A data to memory command must be executed before using the title to memory command.

**[RETURN]** returns to the sequencing special functions menu.

## HP-GL CONSIDERATIONS

### HP-GL Commands Can Be Entered Locally, or Be Included in a Sequence

HP-GL (Hewlett-Packard Graphics Language) can create customized messages or illustrations on the screen of the network analyzer. To use HP-GL, the instrument must be in system controller mode.

HP-GL commands should be entered into a title string using the **[DISPLAY] [MORE] [TITLE]** and character selection menu.

The **[TITLE TO P MTR/HPIB]** or **[TITLE TO PRINTER]** sequencing commands send the HP-GL command string to the instrument's HP-GL address. The network analyzer needs no HP-IB cables connected to it to perform HP-GL commands. The address of the network analyzer HP-GL graphics interface is always offset from the instrument's HP-IB address by 1:

- If the current instrument address is an even number:  
HP-GL address = instrument address + 1.
- If the current instrument address is an odd number:  
HP-GL address = instrument address - 1.

### Special Commands Required for HP-GL

Two HP-GL commands require special consideration when used in local operation or in sequencing. These are explained below:

**Plot Absolute (HP-GL command: PA).** The syntax for this command is PAx,y where x and y are screen location coordinates separated by a comma. The title function on the network analyzer does not have a comma, so the network analyzer allows x and y coordinates to be separated with a forward slash "/".

**Label (HP-GL command: LB).** The syntax for this command is LB[text][etx]. The label command will print ASCII characters until the etx command is seen. The etx is the ASCII value 3 (not the ASCII character 3).

The network analyzer title function does not have the ASCII value 3, so the instrument allows the LB command to be terminated with the **[END OF LABEL]** command (accessed by pressing **[DISPLAY] [MORE] [TITLE] [MORE] [END OF LABEL]**).

HP-GL is described in Appendix D of the *HP-IB Quick Reference* and in *Example 3, User Interface*, in the *HP-IB Programming Guide*. Both documents are behind the HP-IB tab in this volume.

## ENTERING SEQUENCES USING HP-IB

A sequence can be created in an external computer using HP-IB codes. The sequence can be electronically entered into the network analyzer over HP-IB. The process is the same as entering a sequence through the front panel — the same keystrokes are used. This method replaces the keystrokes with HP-IB commands. The following is a procedure for entering a sequence over HP-IB:

1. Send the HP-IB command NEWSEQx where x is a number from 1 to 6 (indicates which softkey position to use for the new sequence).
2. Send the HP-IB commands for the measurement.
3. Terminate with the HP-IB command DONM (done modify).

## READING SEQUENCES USING HP-IB

An external controller can read the commands in any sequence (in HP-IB command format). Send the following command to the network analyzer:

OUTPSEQx where x is a number from 1 to 6 — representing the position of the desired sequence.

Allocate an adequate amount of string variable space in the external controller and execute an ENTER statement.

## DECISION-MAKING SEQUENCE EXAMPLES

### Limit Test Example Sequence:

This example assumes limit line setup commands have been entered earlier in the sequence:

Keys Pressed	Sequence List On Screen	Explanation
[SYSTEM] [LIMIT MENU] [LIMIT LINE ON]	LIMIT LINE ON	Turn on previously set up limit lines.
[LIMIT TEST ON] [MEAS] [TRANSMISSN] [SCALE REF] [2] [x1]	LIMIT TEST ON TRANSMISSN SCALE/DIV 2 x 1	Turn limit testing on. Measurement commands.
[MENU] [TRIGGER MENU] [SINGLE]	SINGLE	Update the data and limit test.
[SYSTEM] [SEQUENCING MENU] [SPECIAL FUNCTIONS] [DECISION MAKING] [IF LIMIT TEST PASS] [SEQUENCE 4 SEQ4] [RETURN] [MORE] [EMIT BEEP] [RETURN] [PAUSE]	IF LIMIT TEST PASS THEN DO SEQUENCE 4  EMIT BEEP PAUSE	Jump to the sequence in sequence position 4 if The limit test passes.  Test failed, beep to inform operator. Pause to let the operator change DUT.
[SYSTEM] [DO SEQUENCE] [SEQUENCE 1 SEQ1] [DONE SEQ MODIFY]	DO SEQUENCE SEQUENCE 1	Jump back to the start of this sequence.  Exit the modify (edit) mode.

## Loop Counter Example Sequence:

Initial Sequence Position and Title: SEQUENCE 1 SEQ1

Keys Pressed	Sequence List On Screen	Explanation
[SYSTEM] [NEW SEQ/MODIFY SEQ] [SEQUENCE 1 SEQ1]	Start of Sequence	Enter modify (edit) mode.
[RECALL] [RECALL PRST STATE]	RECALL PRST STATE	Preset the instrument.
[MEAS] [TRANSMISSN]	TRANSMISSN	Set up a transmission measurement.
[LOCAL] [SYSTEM CONTROLLER]	SYSTEM CONTROLLER	Set the network analyzer to system controller mode
[SET ADDRESSES] [ADDRESS: PRINTER] [1] [x1]	ADDRESS: PRINTER 1 x1	Tell the network analyzer the address of the printer.
[SYSTEM] [SEQUENCING MENU] [SPECIAL FUNCTIONS] [DECISION MAKING] [LOOP COUNTER] [5] [x1]	LOOP COUNTER 5 x1	Set loop counter value to 5.
[SYSTEM] [DO SEQUENCE] [SEQUENCE 2 SEQ2]	DO SEQUENCE SEQUENCE 2	Jump to the sequence in sequence position 2.
[DONE SEQ MODIFY]		Leave the modify (edit) mode.

Second Sequence Position and Title: SEQUENCE 2 SEQ2

Keys Pressed	Sequence List On Screen	Explanation
[SYSTEM] [NEW SEQ/MODIFY SEQ] [SEQUENCE 1 SEQ1] [DISPLAY] [MORE] [TITLE]	Start of Sequence  TITLE	Enter modify (edit) mode.  Enter the title "DUT[LOOP]"*
Press [ERASE TITLE]. Select D with the knob. Press [SELECT LETTER]. Repeat these steps for letters U and T. Press [MORE] [LOOP COUNTER] [RETURN] [DONE]	     DUT[LOOP]*	     Creates "DUT" title.     Create customized title.
[SYSTEM] [SEQUENCING MENU] [SPECIAL FUNCTIONS] [PAUSE]	   SYSTEM PAUSE	   The operator should connect or change the DUT.
[MENU] [TRIGGER MENU] [SINGLE]  [COPY] [STANDARD PRINT]	   SINGLE  STANDARD PRINT	   Take a sweep to update the data.  Results are printed with title DUTx (x = loop #).
- OR -		
[COPY] [COLOR PRINT]	COLOR PRINT	Results are printed with title DUTx (x = loop #).
[SYSTEM] [SEQUENCING MENU] [SPECIAL FUNCTIONS] [DECISION MAKING] [DECR LOOP COUNTER] DECR LOOP COUNTER	   Decrement loop counter.	
[IF LOOP COUNTER <>0] [SEQUENCE2 SEQ2]	IF LOOP COUNTER <>0 THEN DO SEQUENCE 2	If the value of the loop counter is not equal to zero, loop back and test another DUT.
[DISPLAY] [MORE] [TITLE]	TITLE	If loop counter = zero, exit loop and display "TEST IS FINISHED"
Press [ERASE TITLE]. Enter TEST IS FINISHED with knob and cm [SELECT LETTER] softkey. Press [DONE]	   TEST IS FINISHED	   "TEST IS FINISHED" is displayed on the screen.
[SYSTEM] [DONE SEQ MODIFY]		Exit modify (edit) mode.

\* When the test results are printed, each title will have a different numeric value at the end (DUT00005, DUT00004, DUT00003, DUT00002, and DUT00001). Note that the loop counter value always contains five digits.

# TIME and FREQUENCY DOMAIN TRANSFORMS

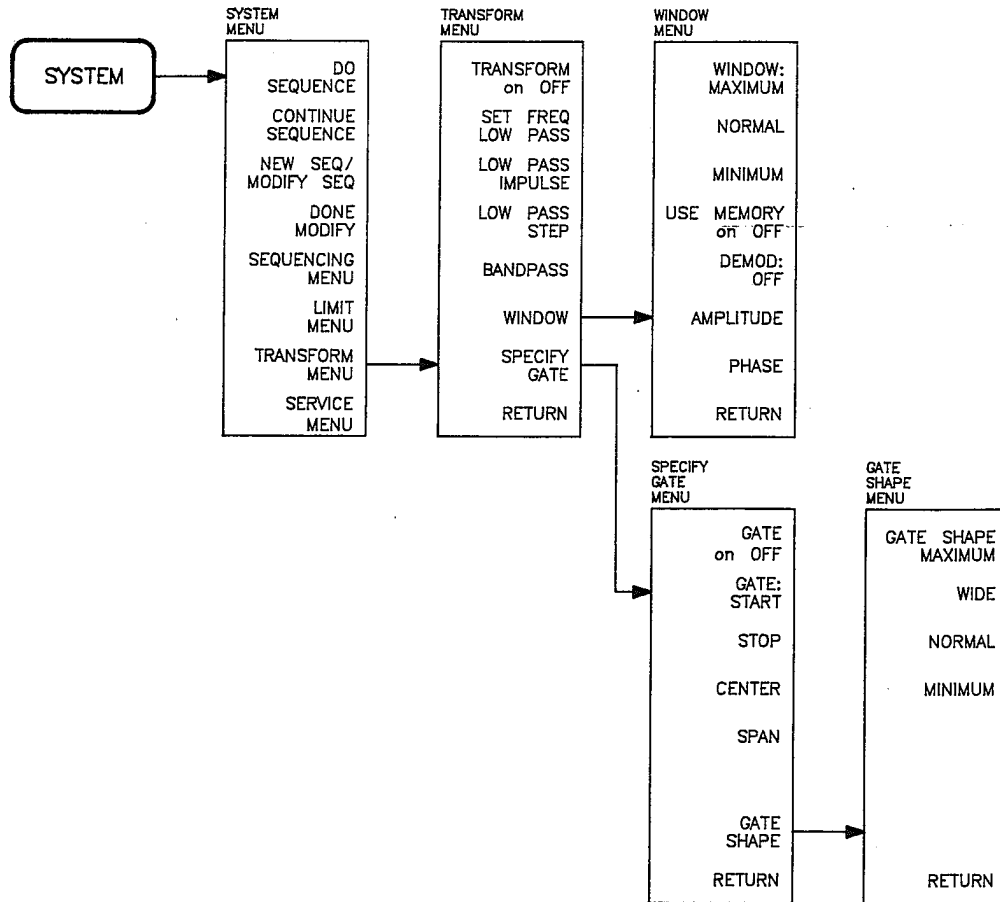

Refer to this foldout menu map as needed when using this tab section.

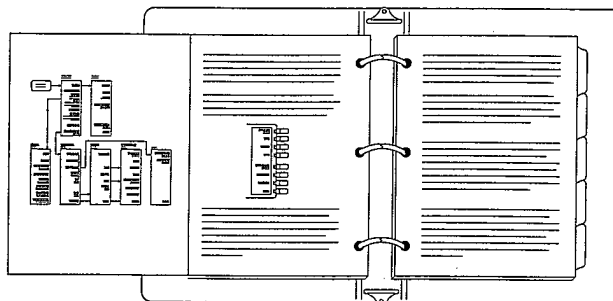

Figure 10-24. Time Domain Transform Menu Map

# Time and Frequency Domain Transforms

## CONTENTS

10-47	Introduction
10-48	General Theory
10-49	Time Domain Bandpass
10-52	Time Domain Low Pass
10-58	Time Domain Concepts
10-67	Transforming CW Time Measurements into the Frequency Domain

## INTRODUCTION

With option 010, the analyzer can transform frequency domain data to the time domain or time domain data to the frequency domain. In normal operation, the analyzer measures the characteristics of a device under test (DUT) as a function of frequency. Using a mathematical technique (the inverse Fourier transform), the analyzer transforms frequency domain information into the time domain, with time as the horizontal display axis. Response values (measured on the vertical axis) now appear separated in time or distance, providing valuable insight into the behavior of the DUT beyond simple frequency characteristics.

**NOTE:** The analyzer can be ordered with option 010, or the option can be added at a later date using the HP 85019C time domain retrofit kit.

The transform used by the analyzer resembles time domain reflectometry (TDR) measurements. TDR measurements, however, are made by launching an impulse or step into the DUT and observing the response in time with a receiver similar to an oscilloscope. In contrast, the analyzer makes swept frequency response measurements, and mathematically transforms the data into a TDR-like display.

The analyzer has three frequency-to-time transform modes:

**Time Domain Bandpass Mode** is designed to measure band-limited devices and is the easiest mode to use. This mode simulates the time domain response to an impulse input.

**Time Domain Low Pass Step Mode** simulates the time domain response to a step input. As in a traditional TDR measurement, the distance to the discontinuity in the DUT, and the type of discontinuity (resistive, capacitive, inductive) can be determined.

**Time Domain Low Pass Impulse Mode** simulates the time domain response to an impulse input (like the bandpass mode). Both low pass modes yield better time domain resolution for a given frequency span than does the bandpass mode. In addition, using the low pass modes you can determine the type of discontinuity. However, these modes have certain limitations that are defined in the low pass section of this chapter.

The analyzer has one time-to-frequency transform mode:

**Forward Transform Mode** transforms CW signals measured over time into the frequency domain, to measure the spectral content of a signal. This mode is known as the CW time mode.

In addition to these transform modes, this chapter discusses special transform concepts such as masking, windowing, and gating.

## GENERAL THEORY

The relationship between the frequency domain response and the time domain response of a network analyzer is defined by the Fourier transform. Because of this transform, it is possible to measure, in the frequency domain, the response of a linear DUT and mathematically calculate the inverse Fourier transform of the data to find the time domain response. The analyzer internal computer makes this calculation using the chirp-Z Fourier transform technique. The resulting measurement is the fully error-corrected time domain reflection or transmission response of the DUT, displayed in near real time.

Table 10-2 lists the useful formats for time domain reflection measurements. Time domain transmission measurements are displayed using the linear magnitude or log magnitude formats, as described later in this chapter.

Table 10-2. Time Domain Reflection Formats

Format	Parameter
LIN MAG	Reflection Coefficient (unitless) ( $0 < \rho < 1$ )
REAL	Reflection Coefficient (unitless) ( $-1 < \rho < 1$ )
LOG MAG	Return Loss (dB)
SWR	Standing Wave Ratio (unitless)

Figure 10-25 illustrates the frequency and time domain reflection responses of a device. The frequency domain reflection measurement is the composite of all the signals reflected by the discontinuities present in the DUT over the measured frequency range.

**NOTE:** In this chapter, all points of reflection are referred to as discontinuities.

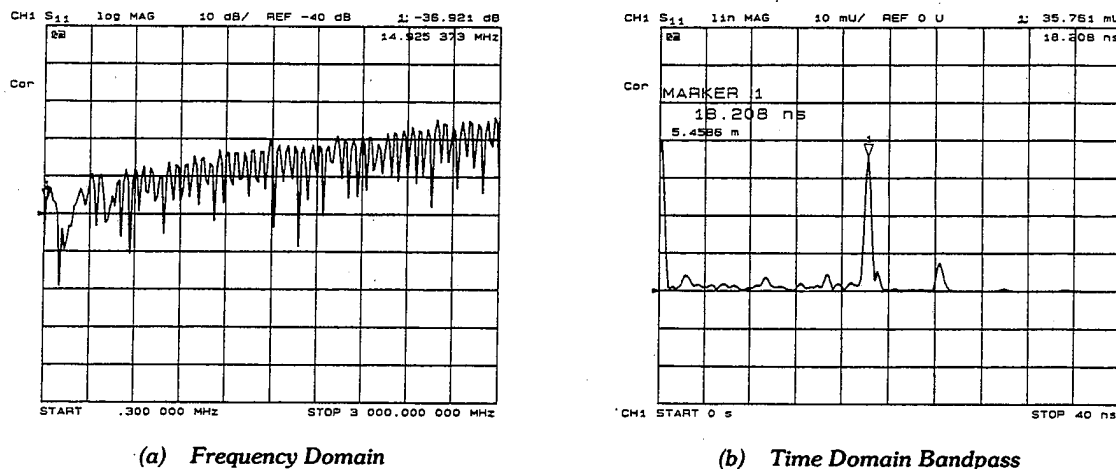

Figure 10-25. Device Frequency Domain and Time Domain Reflection Responses

The time domain measurement shows the effect of each discontinuity as a function of time (or distance), and shows that the device response consists of three separate impedance changes. The second discontinuity has a reflection coefficient magnitude of 0.035 (i.e. 3.5% of the incident signal is reflected). Marker 1 on the time domain trace shows the round-trip time to the discontinuity and back to the reference plane (where the calibration standards are connected): 18.2 nanoseconds. The distance shown (5.45 meters) assumes that the signal travels at the speed of light. The signal actually travels slower than the speed of light in most media (e.g. coax cables). This slower velocity (relative to light) can be compensated for by adjusting the analyzer relative velocity factor. This procedure is described later in this chapter.

Figure 10-24 illustrates the transform menus, which are accessed from the **[SYSTEM]** key.

## **TIME DOMAIN BANDPASS**

This mode is called bandpass because it works with band-limited devices. Traditional TDR requires that the DUT be able to operate down to DC. Using bandpass mode, there are no restrictions on the measurement frequency range. Bandpass mode characterizes the DUT impulse response.

### **Reflection Measurements Using Bandpass Mode**

**NOTE:** Before making time domain reflection measurements, perform the appropriate calibration.

Example:

1. Press **[PRESET]**. The default measurement is reflection on channel 1.
2. Connect one or more lengths of cable, with adapters between cable sections, as shown at the top of Figure 10-26.
3. Press **[SYSTEM] [TRANSFORM MENU] [BANDPASS] [TRANSFORM ON]**.
4. Press **[START] [0] [x1]** to select a start time of zero seconds.
5. Press **[STOP] [4] [0] [G/n]** to select a stop time of 40 nanoseconds.



**NOTE:** In the time domain, the STIMULUS keys ([START], [STOP], [CENTER] and [SPAN]) refer to time, and can be used to change the horizontal (time) axis of the display, independent of the chosen frequency range. To set the STOP time long enough to let you "see" the end of the cable under test, enter a STOP time of 10 nanoseconds per meter of cable under test. This is a good rule-of-thumb number that accounts for the approximate round-trip time for most cables.

6. Press [FORMAT] [LIN MAG] for a display of reflection coefficient versus time (or distance).
7. Press [SCALE REF] [AUTO SCALE].

Figure 10-26 shows typical frequency and time domain responses of a reflection measurement of two sections of cable.

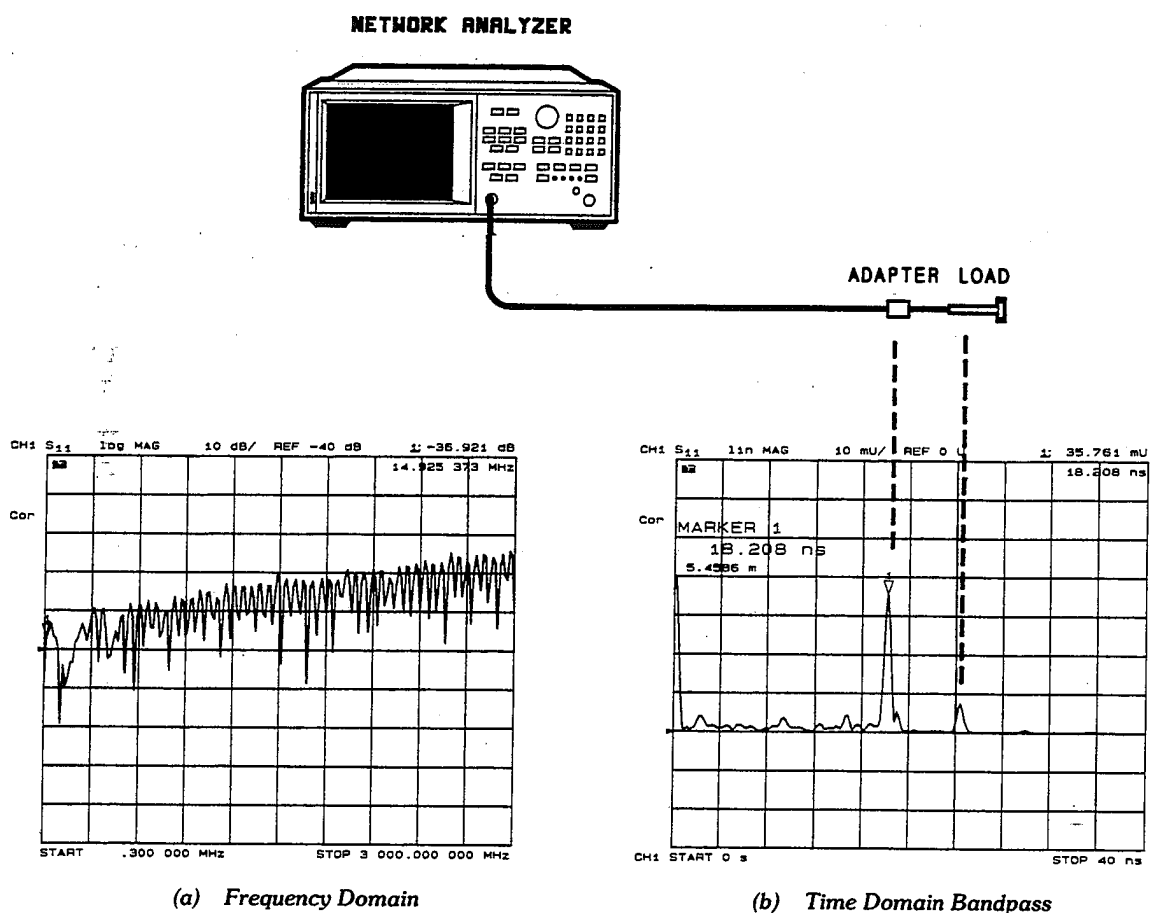

Figure 10-26. A Reflection Measurement of Two Cables

The ripples in reflection coefficient versus frequency in the frequency domain measurement are caused by the reflections at each connector “beating” against each other.

One at a time, loosen the connectors at each end of the cable and observe the response in both the frequency domain and the time domain. The frequency domain ripples grow as each connector is loosened, corresponding to a larger reflection adding in and out of phase with the other reflections. The time domain responses grow as you loosen the connector that corresponds to each response.

**Interpreting the Bandpass Reflection Response Horizontal Axis.** In bandpass reflection measurements, the horizontal axis represents the time it takes for an impulse launched at the test port to reach a discontinuity and return to the test port (the two-way travel time). In Figure 10-26, each connector is a discontinuity.

**Interpreting the Bandpass Reflection Response Vertical Axis.** The quantity displayed on the vertical axis depends on the selected format. The common formats are listed in Table 10-2. The default format is LOG MAG (logarithmic magnitude), which displays the return loss in decibels (dB). LIN MAG (linear magnitude) is a format that displays the response as reflection coefficient ( $\rho$ ). This can be thought of as an average reflection coefficient of the discontinuity over the frequency range of the measurement. Use the REAL format only in low pass mode.

### Adjusting the Relative Velocity Factor

A marker provides both the time (x2) and the electrical length (x2) to a discontinuity. To determine the physical length, rather than the electrical length, change the velocity factor to that of the medium under test:

1. Press [CAL] [MORE] [VELOCITY FACTOR].
2. Enter a velocity factor between 0 and 1.0 (1.0 corresponds to the speed of light in a vacuum). Most cables have a velocity factor of 0.66 (polyethylene dielectrics) or 0.70 (teflon dielectrics).

**NOTE:** To cause the markers to read the actual one-way distance to a discontinuity, (rather than the round trip distance) enter one-half the actual velocity factor.

### Transmission Measurements Using Bandpass Mode

The bandpass mode can also transform transmission measurements to the time domain. For example, this mode can provide information about a surface acoustic wave (SAW) filter that is not apparent in the frequency domain. Figure 10-27 illustrates a time domain bandpass measurement of a 321 MHz SAW filter.

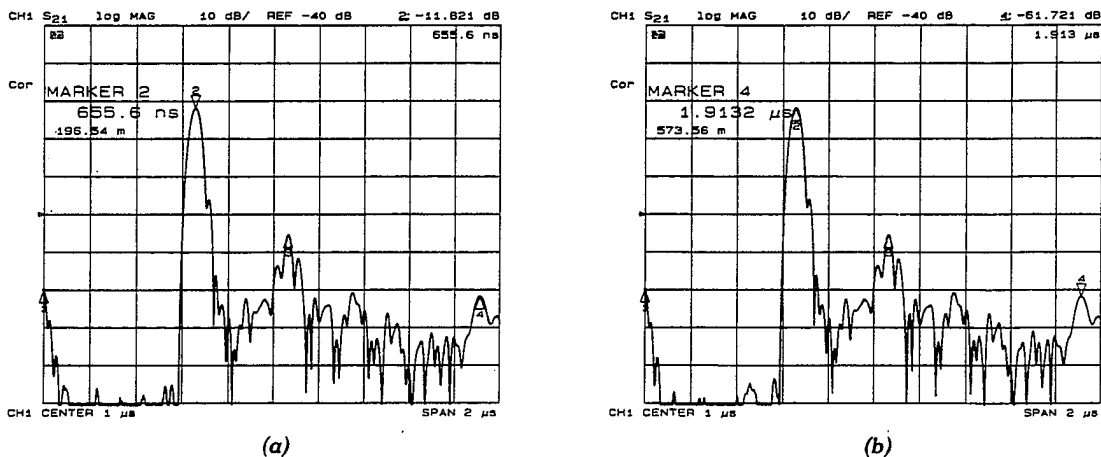

Figure 10-27. Transmission Measurement in Time Domain Bandpass Mode

**Interpreting the Bandpass Transmission Response Horizontal Axis.** In time domain transmission measurements, the horizontal axis is displayed in units of time. The time axis indicates the propagation delay through the device. Note that in time domain transmission measurements, the value displayed is the actual delay (not  $\times 2$ ). The marker provides the propagation delay in both time and distance.

Marker 2 in Figure 10-27 (a) indicates the main path response through the device, which has a propagation delay of 655.6 ns, or about 196.5 meters in electrical length. Marker 4 in Figure 10-27 (b) indicates the triple-travel path response at 1.91  $\mu$ s, or about 573.5 meters. The response at marker 1 (at 0 seconds) is an RF feedthrough leakage path. In addition to the triple travel path response, there are several other multi-path responses through the device, which are inherent in the design of a SAW filter.

**Interpreting the Bandpass Transmission Response Vertical Axis.** In the log magnitude format, the vertical axis displays the transmission loss or gain in dB; in the linear magnitude format it displays the transmission coefficient ( $\tau$ ). Think of this as an average of the transmission response over the measurement frequency range.

## TIME DOMAIN LOW PASS

This mode is used to simulate a traditional time domain reflectometry (TDR) measurement. It provides information to determine the type of discontinuity (resistive, capacitive, or inductive) that is present. Low pass provides the best resolution for a given bandwidth in the frequency domain. It may be used to give either the step or impulse response of the DUT.

The low pass mode is less general-purpose than the bandpass mode because it places strict limitations on the measurement frequency range. The low pass mode requires that the frequency domain data points are harmonically related from DC to the stop frequency. That is,  $\text{stop} = n \times \text{start}$ , where  $n =$  number of points. For example, with a start frequency of 300 kHz and 101 points, the stop frequency would be 30.3 MHz. Since the frequency range of the analyzer starts at 300 kHz, the DC frequency response is extrapolated from the lower frequency data. The requirement to pass DC is the same limitation that exists for traditional TDR.

### Setting Frequency Range for Time Domain Low Pass

Before a low pass measurement is made, the measurement frequency range must meet the ( $\text{stop} = n \times \text{start}$ ) requirement described above. The **[SET FREQ LOW PASS]** softkey performs this function automatically: the stop frequency is set close to the entered stop frequency, and the start frequency is set equal to  $\text{stop}/n$ . For convenience, the **[SET FREQ LOW PASS]** softkey is in both the transform menu and the calibration menu.

If the low end of the measurement frequency range is critical, it is best to calculate approximate values for the start and stop frequencies before pressing **[SET FREQ LOW PASS]** and calibrating. This avoids distortion of the measurement results. To see an example, select the preset values of 201 points and a 300 kHz to 1.3 GHz frequency range. Now press **[SET FREQ LOW PASS]** and observe the change in frequency values. The stop frequency changes to 1.299 GHz, and the start frequency changes to 6.467 MHz. This would cause a distortion of measurement results for frequencies from 300 kHz to 6.467 MHz.

**NOTE:** If the start and stop frequencies do not conform to the low pass requirement before a low pass mode (step or impulse) is selected and transform is turned on, the analyzer resets the start and stop frequencies. If error correction is on when the frequency range is changed, this turns it off.

**Minimum Allowable Stop Frequencies.** The lowest analyzer measurement frequency is 300 kHz, therefore for each value of n there is a minimum allowable stop frequency that can be used. That is, the minimum stop frequency =  $n \times 300$  kHz. Table 10-3 lists the minimum frequency range that can be used for each value of n for low pass time domain measurements.

*Table. 10-3. Minimum Frequency Ranges for Time Domain Low Pass*

Number of Points	Minimum Frequency Range
3	300 kHz to 0.9 MHz
11	300 kHz to 3.3 MHz
26	300 kHz to 7.8 MHz
51	300 kHz to 15.3 MHz
101	300 kHz to 30.3 MHz
201	300 kHz to 60.3 MHz
401	300 kHz to 120.3 MHz
801	300 kHz to 240.3 MHz
1601	300 kHz to 480.3 MHz

## Reflection Measurements in Time Domain Low Pass

Example:

1. Press **[PRESET]**. The default measurement is reflection on channel 1.
2. Press **[CAL] [CALIBRATE MENU] [SET FREQ LOW PASS]**. The message "LOW PASS: FREQ LIMITS CHANGED" will be displayed.
3. Connect one or more lengths of cable, with adapters between cable sections. Leave the last cable unterminated.
4. Press **[SYSTEM] [TRANSFORM MENU] [LOW PASS STEP] [TRANSFORM ON]**.
5. Press **[START] [0] [x1]** to select a start time of 0 seconds.
6. Press **[STOP] [4] [0] [G/n]** to select a stop time of 40 nanoseconds.

**NOTE:** In the time domain, the STIMULUS keys (**[START]**, **[STOP]**, **[CENTER]** and **[SPAN]**) refer to time, and can be used to change the horizontal (time) axis of the display, independent of the chosen frequency range.

7. Press **[FORMAT] [MORE] [REAL] [SCALE REF] [AUTO SCALE]** to view the step response, which will be similar to Figure 10-28 (a). (The step response is reflected back from the unterminated cable.)

8. Press **[SYSTEM] [TRANSFORM MENU] [LOW PASS IMPULSE]** to view the impulse response, similar to Figure 10-28 (b).

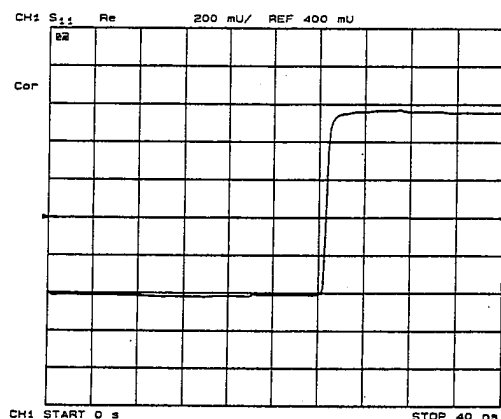

(a) Low Pass Step

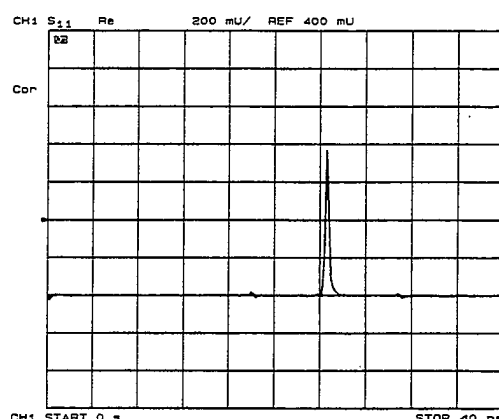

(b) Low Pass Impulse

Figure 10-28. Time Domain Low Pass Measurements of an Unterminated Cable

9. Now connect a short circuit to the unterminated cable and press **[SCALE REF] [AUTO SCALE]** to center the display. The polarity of the impulse response is now reversed.
10. Press **[SYSTEM] [TRANSFORM MENU] [LOW PASS STEP]** to view the low pass step response with the polarity reversed.

**Interpreting the Low Pass Response Horizontal Axis.** The low pass measurement horizontal axis is the two-way travel time to the discontinuity (as in the bandpass mode). The marker displays both the two-way time and the electrical length along the trace. To determine the actual physical length, enter the appropriate velocity factor as described earlier in this chapter under "Adjusting the Relative Velocity Factor".

**Interpreting the Low Pass Response Vertical Axis.** The vertical axis depends on the chosen format. In the low pass mode, the frequency domain data is taken at harmonically related frequencies and extrapolated to DC. Because this results in the inverse Fourier transform having only a real part (the imaginary part is zero), the most useful low pass step mode format in this application is the real format. It displays the response in reflection coefficient units. This mode is similar to the traditional TDR response, which displays the reflected signal in a real format (volts) versus time (or distance) on the horizontal axis.

The real format can also be used in the low pass impulse mode, but for the best dynamic range for simultaneously viewing large and small discontinuities, use the log magnitude format.

## Fault Location Measurements Using Low Pass

As described, the low pass mode can simulate the TDR response of the device under test. This response contains information useful in determining the type of discontinuity present. Figure 10-29 illustrates the low pass responses of known discontinuities. Each circuit element was simulated to show the corresponding low pass time domain reflection response waveform. The low pass mode gives the device response either to a step or to an impulse stimulus. Mathematically, the low pass impulse stimulus is the derivative of the step stimulus.









Element	Step Response	Impulse Response
Open	 Unity Reflection	 Unity Reflection
Short	 Unity Reflection, $-180^\circ$	 Unity Reflection, $-180^\circ$
Resistor $R > Z_0$	 Positive Level Shift	 Positive Peak
Resistor $R < Z_0$	 Negative Level Shift	 Negative Peak
Inductor	 Positive Peak	 Positive Then Negative Peaks
Capacitor	 Negative Peak	 Negative Then Positive Peaks

Figure 10-29. Simulated Low Pass Step and Impulse Response Waveforms (Real Format)

Figure 10-30 shows example cables with discontinuities (faults) using the low pass step mode with the real format.

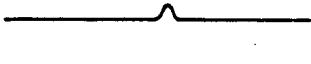
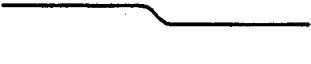

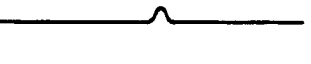
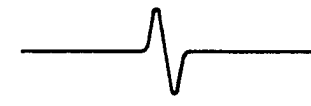
(a) Crimped Cable (Capacitive)

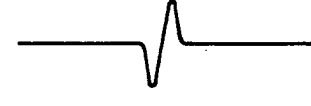
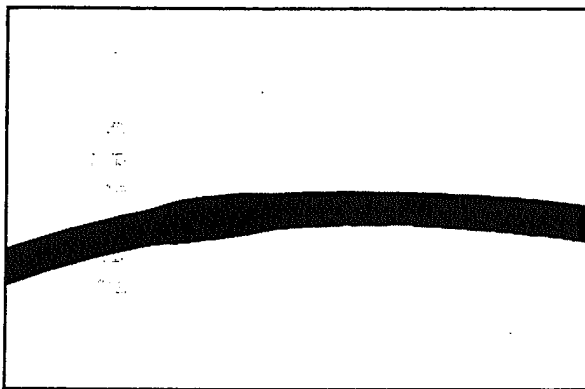
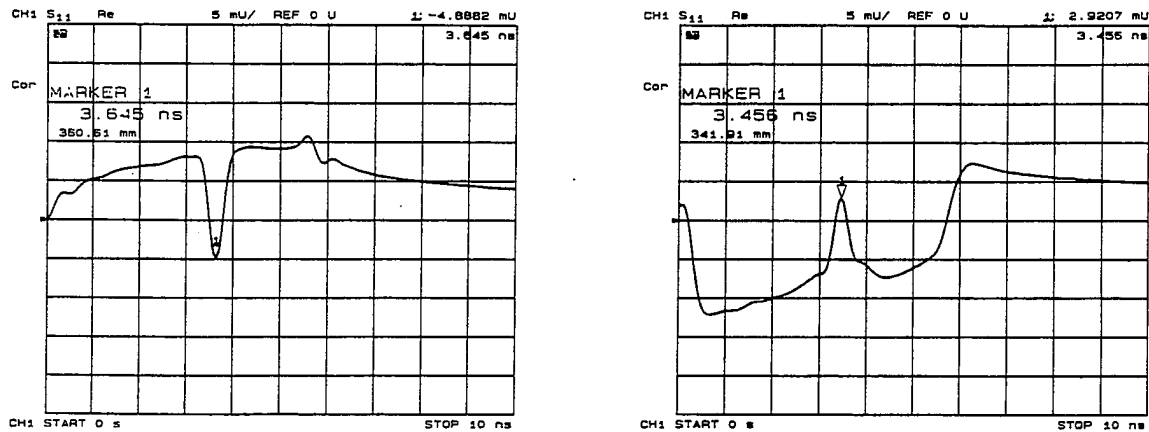
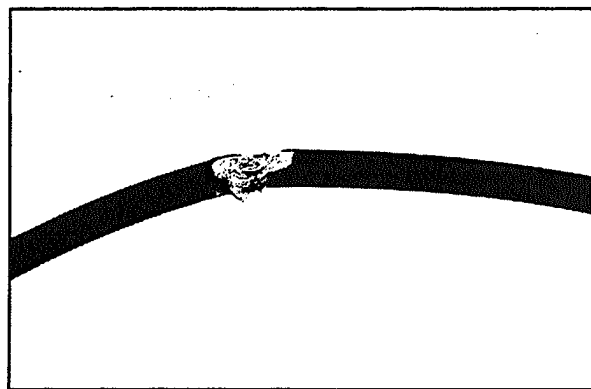

(b) Frayed Cable (Inductive)

Figure 10-30. Low Pass Step Measurements of Common Cable Faults (Real Format)

### Transmission Measurements in Time Domain Low Pass

**Measuring Small Signal Transient Response Using Low Pass Step.** Use the low pass mode to analyze the DUT small signal transient response. The transmission response of a device to a step input is often measured at lower frequencies, using a function generator (to provide the step to the DUT) and a sampling oscilloscope (to analyze the DUT output response). The low pass step mode extends the frequency range of this type of measurement to 1.3 GHz (3 GHz with an option 003).

The step input shown in Figure 10-31 is the inverse Fourier transform of the frequency domain response of a thru measured at calibration. The step rise time is proportional to the highest frequency in the frequency domain sweep; the higher the frequency, the faster the rise time. The frequency sweep in Figure 10-31 is from 10 MHz to 1 GHz.

Figure 10-31 also illustrates the time domain low pass response of an amplifier under test. The average group delay over the measurement frequency range is the difference in time between the step and the amplifier response. This time domain response simulates an oscilloscope measurement of the amplifier's small signal transient response. Note the ringing in the amplifier response that indicates an underdamped design.

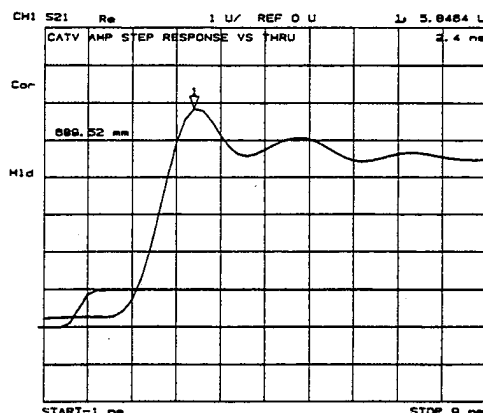

Figure 10-31. Time Domain Low Pass Measurement of an Amplifier Small Signal Transient Response

**Interpreting the Low Pass Step Transmission Response Horizontal Axis.** The low pass transmission measurement horizontal axis displays the average transit time through the device over the frequency range used in the measurement. The response of the thru connection used in the calibration is a step that reaches 50% unit height at approximately time = 0. The rise time is determined by the highest frequency used in the frequency domain measurement. The step is a unit high step, which indicates no loss for the thru calibration. When a device is inserted, the time axis indicates the propagation delay or electrical length of the device. The markers read the electrical delay in both time and distance. The distance can be scaled by an appropriate velocity factor as described earlier in this chapter under "Adjusting the Relative Velocity Factor".

**Interpreting the Low Pass Step Transmission Response Vertical Axis.** In the real format, the vertical axis displays the transmission response in real units (e.g. volts). For the amplifier example in Figure 10-31 if the amplifier input is a step of 1 volt, the output, 2.4 nanoseconds after the step (indicated by marker 1), is 5.84 volts.

In the log magnitude format, the amplifier gain is the steady state value displayed after the initial transients die out.

**Measuring Separate Transmission Paths through the DUT Using Low Pass Impulse Mode.** The low pass impulse mode can be used to identify different transmission paths through a DUT that has a response at frequencies down to DC (or at least has a predictable response, above the noise floor, below 300 kHz). For example, use the low pass impulse mode to measure the relative transmission times through a multipath device such as a power divider. Another example is to measure the pulse dispersion through a broadband transmission line, such as a fiber optic cable. The first example is illustrated in Figure 10-32. The horizontal and vertical axes can be interpreted as already described in this chapter under "Transmission Measurements Using Bandpass Mode".



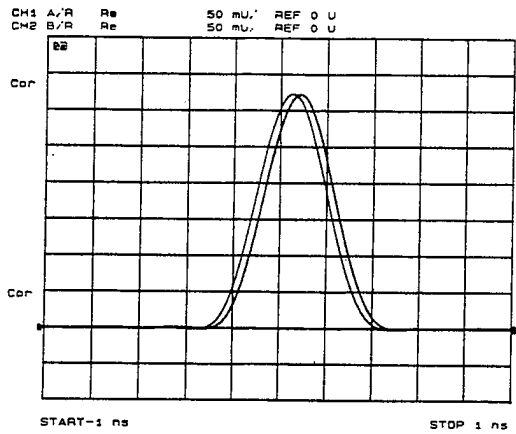

Comparing Transmission Paths through a Power Divider

Figure 10-32. Transmission Measurements Using Low Pass Impulse Mode

## TIME DOMAIN CONCEPTS

### Masking

Masking occurs when a discontinuity (fault) closest to the reference plane affects the response of each subsequent discontinuity. This happens because the energy reflected from the first discontinuity never reaches subsequent discontinuities. For example, if a transmission line has two discontinuities that each reflect 50% of the incident voltage, the time domain response (real format) shows the correct reflection coefficient for the first discontinuity ( $\rho=0.50$ ). However, the second discontinuity appears as a 25% reflection ( $\rho=0.25$ ) because only half the incident voltage reached the second discontinuity.

**NOTE:** This example assumes a lossless transmission line. Real transmission lines, with loss, attenuate signals as a function of the distance from the reference plane.

As an example of masking due to line loss, consider the time domain response of a 3 dB attenuator and a short circuit. The impulse response (log magnitude format) of the short circuit alone is a return loss of 0 dB, as shown in Figure 10-33 (a). When the short circuit is placed at the end of the 3 dB attenuator, the return loss is -6 dB, as shown in Figure 10-33 (b). This value actually represents the forward and return path loss through the attenuator, and illustrates how a lossy network can affect the responses that follow it.

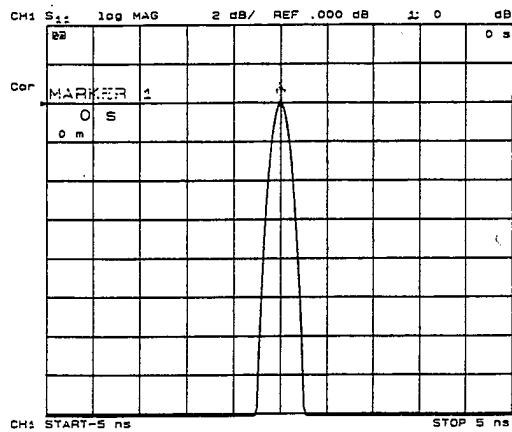

(a) Short Circuit

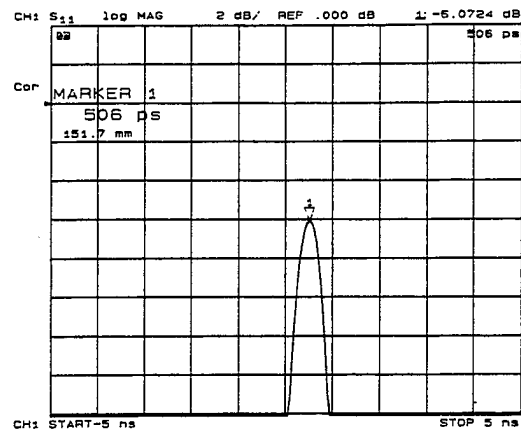

(b) Short Circuit at the End of a 3 dB Pad

Figure 10-33. Masking Example

## Windowing

The analyzer provides a windowing feature that makes time domain measurements more useful for isolating and identifying individual responses. Windowing is needed because of the abrupt transitions in a frequency domain measurement at the start and stop frequencies. The band limiting of a frequency domain response causes overshoot and ringing in the time domain response, and causes a non-windowed impulse stimulus to have a  $\text{sin}(kt)/kt$  shape, where  $k = \pi/\text{frequency span}$  (see Figure 10-34). This has two effects that limit the usefulness of the time domain measurement:

1. Finite impulse width (or rise time). This limits the ability to resolve between two closely spaced responses. The effects of the finite impulse width cannot be improved without increasing the frequency span of the measurement (see Table 10-4).
2. Sidelobes. The impulse sidelobes limit the dynamic range of the time domain measurement by hiding low-level responses within the sidelobes of higher level responses. The effects of sidelobes can be improved by windowing (see Table 10-4).

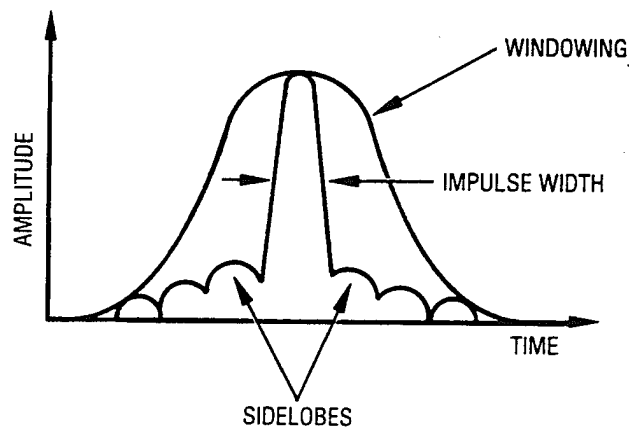

Figure 10-34. Impulse Width, Sidelobes, and Windowing

Windowing improves the dynamic range of a time domain measurement by filtering the frequency domain data prior to converting it to the time domain, producing an impulse stimulus that has lower sidelobes. This makes it much easier to see time domain responses that are very different in magnitude. The sidelobe reduction is achieved, however, at the expense of increased impulse width. The effect of windowing on the step stimulus (low pass mode only) is a reduction of overshoot and ringing at the expense of increased rise time.

To select a window, press **[SYSTEM] [TRANSFORM MENU] [WINDOW]**. A menu is presented that allows the selection of three window types (see Table 10-4).

*Table 10-4. Impulse Width, Sidelobe Level, and Windowing Values*

<b>Window Type</b>	<b>Impulse Sidelobe Level</b>	<b>Low Pass Impulse Width (50%)</b>	<b>Step Sidelobe Level</b>	<b>Step Rise Time (10 – 90%)</b>
Minimum	–13 dB	0.60/Freq Span	–21 dB	0.45/Freq Span
Normal	–44 dB	0.96/Freq Span	–61 dB	0.99/Freq Span
Maximum	–90 dB	1.38/Freq Span	–90 dB	1.48/Freq Span

**NOTE:** The bandpass mode simulates an impulse stimulus. Bandpass impulse width is twice that of lowpass impulse width. The bandpass impulse sidelobe levels are the same as lowpass impulse sidelobe levels.

Choose one of the three window shapes listed in Table 10-4 Or you can use the knob to select any windowing pulse width (or rise time for a step stimulus) between the softkey values. The time domain stimulus sidelobe levels depend only on the window selected.

**[MINIMUM]** is essentially no window. Consequently, it gives the highest sidelobes.

**[NORMAL]** (the preset mode) gives reduced sidelobes and is the mode most often used.

**[MAXIMUM]** window gives the minimum sidelobes, providing the greatest dynamic range.

**[USE MEMORY on OFF]** remembers a user-specified window pulse width (or step rise time) different from the standard window values.

A window is turned on only for viewing a time domain response, and does not affect a displayed frequency domain response. Figure 10-35 shows the typical effects of windowing on the time domain response of a short circuit reflection measurement.

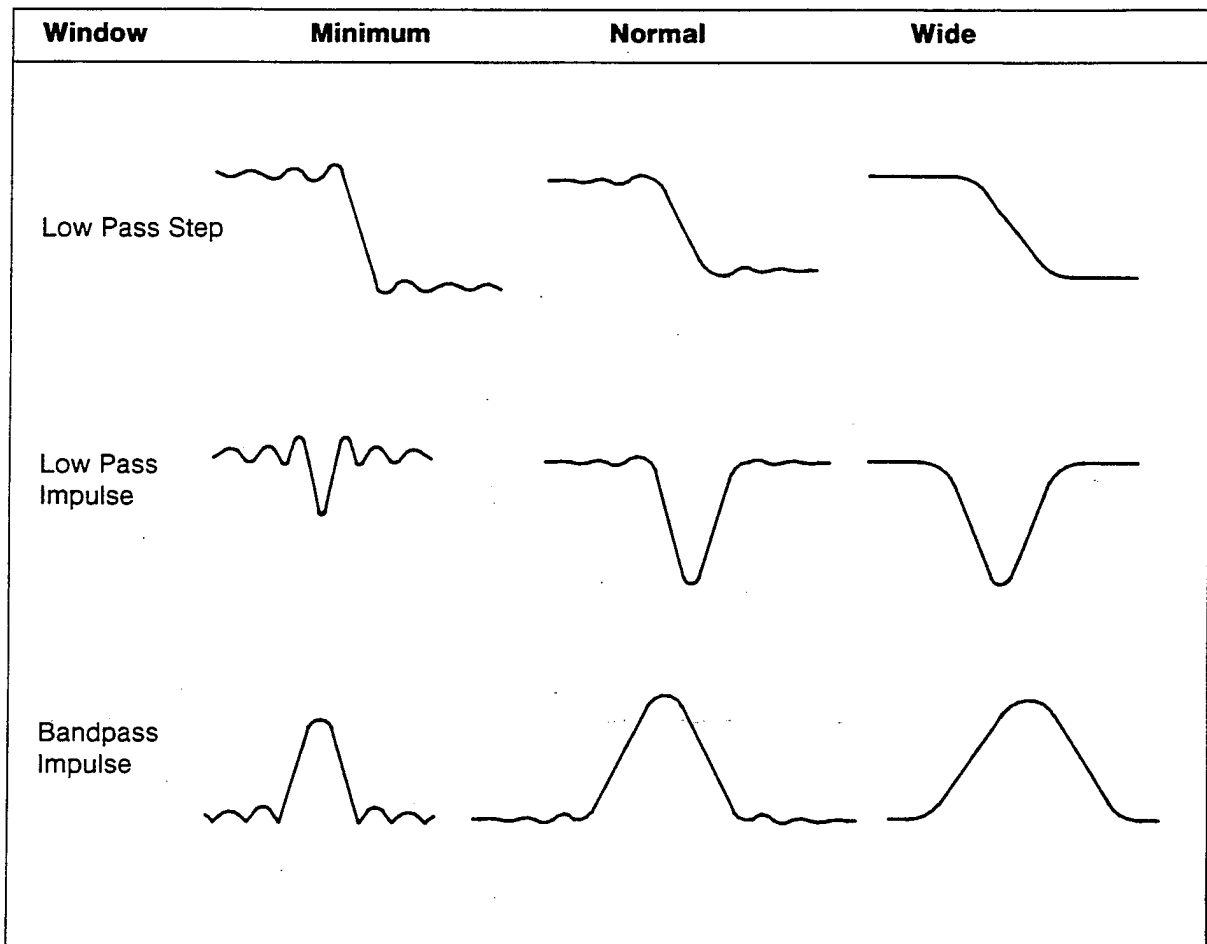

Figure 10-35. The Effects of Windowing on the Time Domain Responses of a Short Circuit

## Range

In the time domain, range is defined as the length in time that a measurement can be made without encountering a repetition of the response, called aliasing. A time domain response repeats at regular intervals because the frequency domain data is taken at discrete frequency points, rather than continuously over the frequency band.

Measurement range is equal to  $1/\Delta F$  ( $\Delta F$  is the spacing between frequency data points). Measurement range = (number of points - 1)/frequency span (Hz).

Example:

Measurement = 201 points  
1 MHz to 2.001 GHz

Range =  $1/\Delta F$  or (number of points - 1)/frequency span  
=  $1/(10 \times 10^6)$  or  $(201 - 1)/(2 \times 10^9)$   
=  $100 \times 10^{-9}$  seconds

Electrical length = range x the speed of light ( $3 \times 10^8$  m/s)  
=  $(100 \times 10^{-9} \text{ s}) \times (3 \times 10^8 \text{ m/s})$   
= 30 meters

In this example, the range is 100 ns, or 30 meters electrical length. To prevent the time domain responses from overlapping, the DUT must be 30 meters or less in electrical length for a transmission measurement (15 meters for a reflection measurement). The analyzer limits the stop time to prevent the display of aliased responses.

To increase the time domain measurement range, first increase the number of points, but remember that as the number of points increases, the sweep speed decreases. Decreasing the frequency span also increases range, but reduces resolution.

**RESOLUTION**  
**(Determining the minimum distance between two responses)**

Time domain response resolution is defined as the ability to resolve two closely-spaced responses, or a measure of how close two responses can be to each other and still be distinguished from each other. For responses of equal amplitude, the response resolution is equal to the 50% (-6 dB) impulse width. It is inversely proportional to the measurement frequency span, and is also a function of the window and bandpass mode used in the transform.

The tables below shows the resolutions available using the widest frequency spans available for the standard instrument (1300 MHz) and option 003 instruments (3 GHz).

*Resolution in Transmission Measurements (Air Dielectric)*

Windowing Selected	1300 MHz Span		3 GHz Span	
	Bandpass Mode	Low Pass Mode	Bandpass Mode	Low Pass Mode
Minimum	27.7 cm	13.8 cm	12.0 cm	6.0 cm
Normal	44.3 cm	22.2 cm	19.2 cm	9.6 cm
Maximum	63.7 cm	31.8 cm	27.6 cm	13.8 cm
<b>Note:</b> Divide the resolution shown above by 2 for reflection measurements.				

*Resolution in Transmission Measurements (Teflon Dielectric)*

Windowing Selected	1300 MHz Span		3 GHz Span	
	Bandpass Mode	Low Pass Mode	Bandpass Mode	Low Pass Mode
Minimum	19.4 cm	9.69 cm	8.4 cm	4.2 cm
Normal	31.0 cm	15.5 cm	13.4 cm	6.7 cm
Maximum	44.6 cm	22.3 cm	19.3 cm	9.7 cm
<b>Note:</b> Divide the resolution shown above by 2 for reflection measurements.				

*Resolution in Transmission Measurements (Polyethylene Dielectric)*

	1300 MHz Span		3 GHz Span	
Windowing Selected	Bandpass Mode	Low Pass Mode	Bandpass Mode	Low Pass Mode
Minimum	18.3 cm	9.14 cm	7.9 cm	4.0 cm
Normal	29.2 cm	14.6 cm	12.7 cm	6.3 cm
Maximum	42.0 cm	21.0 cm	18.2 cm	9.1 cm

**Note:** Divide the resolution shown above by 2 for reflection measurements.

## CALCULATING RESPONSE RESOLUTION

### In Transmission Measurements

To find the minimum distance between two responses, use the following formula:

$$\text{Min Distance} = \text{Impulse Width} \times (\text{Speed of Light} \times \text{velocity factor})$$

**Determining (50%) impulse width.** The 50% impulse width can be determined using the table below.

*Determining Impulse Width*

Windowing Selected	Bandpass Mode	Low Pass Mode
Minimum	1.2/span	0.6/span
Normal	1.92/span	0.96/span
Maximum	2.76/span	1.38/span

For example: Bandpass mode with minimum windowing using a 1300 MHz span. The table indicates you should divide 1.2 by the selected frequency span (1300 Mhz). In this example impulse width (in seconds) is equal to  $0.923 \times 10^{-9}$ , (0.923 nanoseconds).

### Example 1

**Determining minimum distance between two responses, bandpass mode, minimum windowing, 1300 MHz frequency span:**

This example assumes you are measuring a cable with a teflon dielectric, which has a velocity factor of 0.7.

The table above shows that impulse width (in seconds) is equal to  $1.2/1300$  MHz, which equals  $0.923 \times 10^{-9}$ .

$$\begin{aligned} \text{Minimum distance (in cm)} &= \text{Impulse Width} \times \text{Speed of Light} \times \text{Velocity Factor} \\ &= (0.923 \times 10^{-9} \text{ seconds}) \times ((3 \times 10^{10} \text{ cm/s}) \times 0.7) \\ &= 19.4 \text{ cm} \end{aligned}$$

In this example, two equal responses can be distinguished when they are separated by at least 19.4 centimeters.

## In Reflection Measurements

For reflection measurements (which measure the round trip time to the response), divide the minimum distance between responses (resolution) by 2. The example given above, using reflection measurement type, would have a resolution of 9.7 cm.

Figure 10-36 illustrates the effects of response resolution. The solid line shows the actual reflection measurement of two approximately equal discontinuities (the input and output of an SMA barrel). The dashed line shows the approximate effect of each discontinuity, if it could be measured separately.

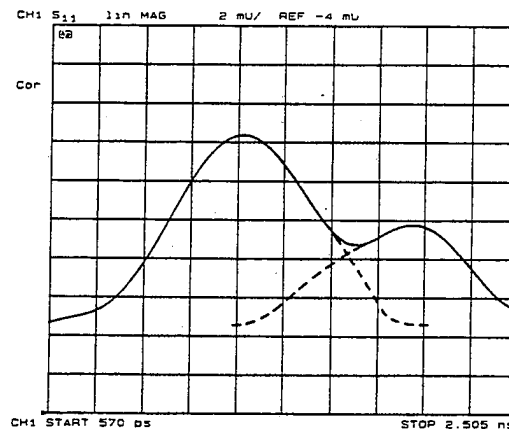

Figure 10-36. Response Resolution

While increasing the frequency span increases the response resolution, keep the following points in mind:

- The time domain response noise floor is directly related to the frequency domain data noise floor. Because of this, if the frequency domain data points are taken at or below the measurement noise floor, the time domain measurement noise floor is degraded.
- The time domain measurement is an average of the response over the frequency range of the measurement. If the frequency domain data is measured out-of-band, the time domain measurement is also the out-of-band response.

You may (with these limitations in mind) choose to use a frequency span that is wider than the DUT bandwidth to achieve better resolution.

**Range Resolution.** Time domain range resolution is defined as the ability to locate a single response in time. If only one response is present, range resolution is a measure of how closely you can pinpoint the peak of that response. The range resolution is equal to the digital resolution of the display, which is the time domain span divided by the number of points on the display. To get the maximum range resolution, center the response on the display and reduce the time domain span. The range resolution is always much finer than the response resolution.

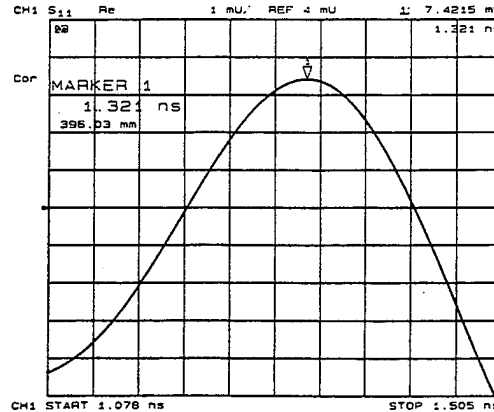

Figure 10-37. Range Resolution of a Single Discontinuity

## Gating

Gating provides the flexibility of selectively removing time domain responses. The gated time domain responses can then be transformed back to the frequency domain. For reflection (or fault location) measurements, use this feature to remove the effects of unwanted discontinuities in the time domain. You can then view the frequency response of the remaining discontinuities. In a transmission measurement, you can remove the effects of multiple transmission paths.

Figure 10-38 illustrates the time domain response of a SAW filter. Gating has been applied in the time domain to remove the effects of all but the main signal path response. When the gated response is transformed back to the frequency domain, the display shows only the direct path response.

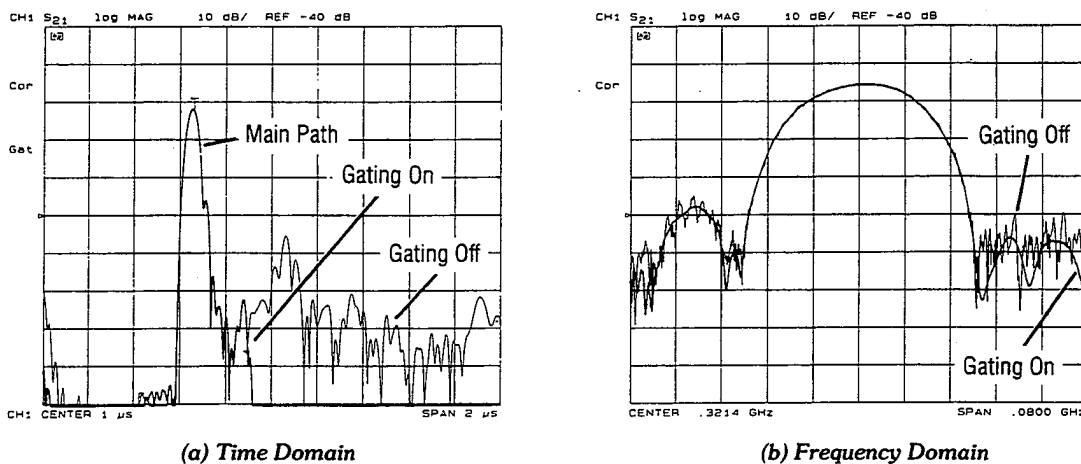

Figure 10-38. SAW Filter Transmission Measurement with Gating



**Setting the Gate.** Think of a gate as a bandpass filter in the time domain (Figure 10-39). When the gate is on, responses outside the gate are mathematically removed from the time domain trace. Enter the gate position as a start and stop time (not frequency) or as a center and span time. The start and stop times are the bandpass filter  $-6$  dB cutoff times. Gates can have a negative span, in which case the responses *inside* the gate are mathematically removed.

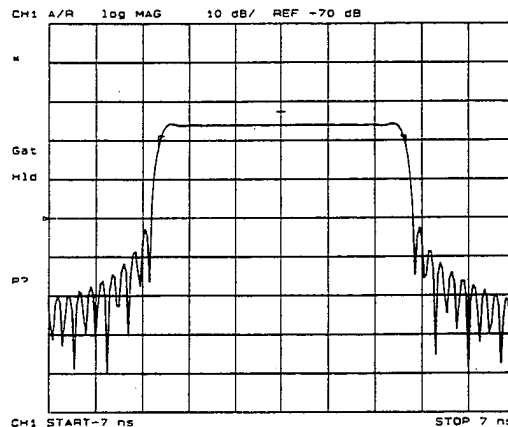

Figure 10-39. Gate Shape

**Selecting Gate Shape.** The four gate shapes available are listed in Table 10-5. Each gate has a different passband flatness, cutoff rate, and sidelobe levels.

Table 10-5. Gate Characteristics

Gate Shape	Passband Ripple	Sidelobe Levels	Cutoff Time	Minimum Gate Span
Gate SpanMinimum	$\pm 0.40$ dB	$-24$ dB	$0.6/\text{Freq Span}$	$1.2/\text{Freq Span}$
Normal	$\pm 0.04$ dB	$-45$ dB	$1.4/\text{Freq Span}$	$2.8/\text{Freq Span}$
Wide	$\pm 0.02$ dB	$-52$ dB	$4.0/\text{Freq Span}$	$8.0/\text{Freq Span}$
Maximum	$\pm 0.01$ dB	$-80$ dB	$11.2/\text{Freq Span}$	$22.4/\text{Freq Span}$

**NOTE:** With 1601 frequency points, gating is available only in the passband mode.

The passband ripple and sidelobe levels are descriptive of the gate shape. The cutoff time is the time between the stop time ( $-6$  dB on the filter skirt) and the peak of the first sidelobe, and is equal on the left and right side skirts of the filter. Because the minimum gate span has no passband, it is just twice the cutoff time. Always choose a gate span wider than the minimum. For most applications, do not be concerned about the minimum gate span, simply use the knob to position the gate markers around the desired portion of the time domain trace.

## TRANSFORMING CW TIME MEASUREMENTS INTO THE FREQUENCY DOMAIN

The analyzer can display the amplitude and phase of continuous wave (CW) signals versus time. For example, use this mode for measurements such as amplifier gain as a function of warm-up time (i.e. drift). In the past, drift measurements were often made using strip chart recorders. The analyzer can display the measured parameter (e.g. amplifier gain) for periods of up to 24 hours and then output the data to a digital plotter for hardcopy results.

These "strip chart" plots are actually measurements as a function of time (time is the independent variable), and the horizontal display axis is scaled in time units. Transforms of these measurements result in frequency domain data. Such transforms are called forward transforms because the transform from time to frequency is a forward Fourier transform, and can be used to measure the spectral content of a CW signal. For example, when transformed into the frequency domain, a pure CW signal measured over time appears as a single frequency spike. The transform into the frequency domain yields a display that looks similar to a spectrum analyzer display of signal amplitude versus frequency.

### Forward Transform Measurements

This is an example of a measurement using the Fourier transform in the forward direction, from the time domain to the frequency domain (see Figure 10-40):

1. Press **[PRESET]**.
2. Press **[MEAS]** and select the desired measurement (in this case transmission).
3. Press **[MENU] [CW FREQ]** and set the CW frequency to the desired value (here 250 MHz). The CW time mode is now active.
4. Press **[STOP]** and enter the time over which you wish to take data (up to 24 hours, in this case 0.1 second).
5. Press **[SYSTEM] [TRANSFORM MENU] [TRANSFORM ON]** to transform the data into the frequency domain.
6. Press **[SPAN]** and set the desired frequency span. For this example, press **[5] [0] [0] [x1]** to increase the frequency span to 500 Hz. The displayed center frequency of 0 Hz represents the CW frequency of 250 MHz entered earlier. The maximum span is 4000 Hz for the default sweep time (100 ms) and number of points (201) (see *Forward Transform Range*).

**NOTE:** In the forward transform mode, the k/m, M/ $\mu$ , and G/n keys terminate a selection as millihertz, microhertz, and nanohertz.

7. Press **[SCALE REF]** and adjust the scale per division and reference position to view the trace centered on the screen.
8. Press **[MKR FCTN] [MKR SEARCH] [MAX]** to see the peak value.

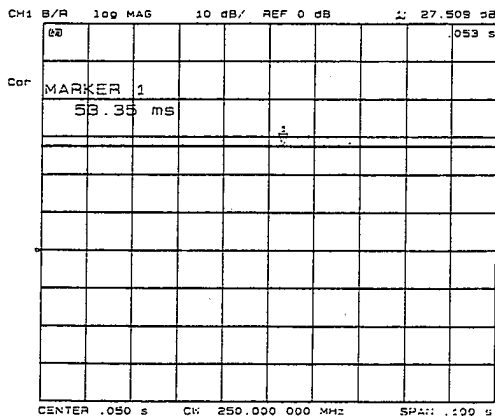

(a) CW Time

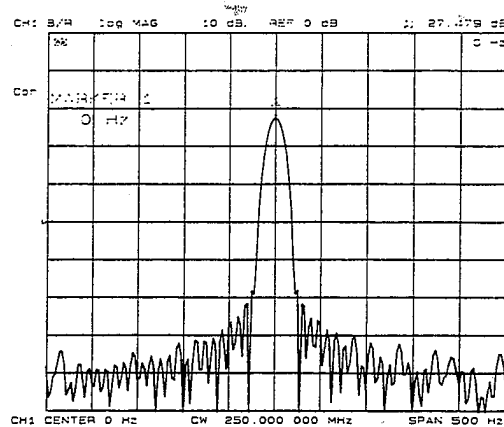

(b) Transform to Frequency Domain

Figure 10-40. Amplifier Gain Measurement

**Interpreting the Forward Transform Vertical Axis.** With the log magnitude format selected, the vertical axis displays dB. This format simulates a spectrum analyzer display of power versus frequency.

**Interpreting the Forward Transform Horizontal Axis.** In a frequency domain transform of a CW time measurement, the horizontal axis is measured in units of frequency. The center frequency is the offset of the CW frequency. For example, with a center frequency of 0 Hz, the CW frequency (250 MHz in the example) is in the center of the display. If the center frequency entered is a positive value, the CW frequency shifts to the right half of the display; a negative value shifts it to the left half of the display. The span value entered with the transform on is the total frequency span shown on the display. (Alternatively, the frequency display values can be entered as start and stop.)

### Demodulating the Results of the Forward Transform

The forward transform can separate the effects of the CW frequency modulation amplitude and phase components. For example, if a DUT modulates the transmission response with a 500 Hz AM signal, you can see the effects of that modulation as shown in Figure 10-41.

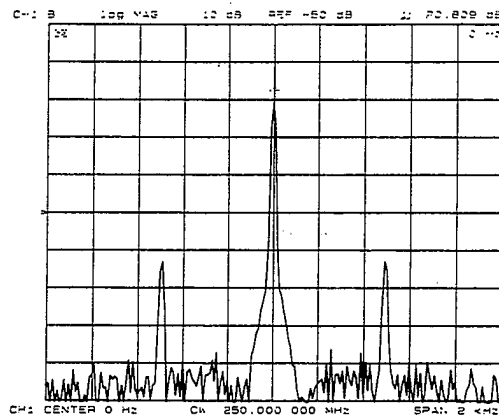

Figure 10-41. Combined Effects of Amplitude and Phase Modulation

Using the demodulation capabilities of the analyzer, it is possible to view the amplitude or the phase component of the modulation separately. The window menu (see Figure 10-25) includes the following softkeys to control the demodulation feature:

**[DEMOD: OFF]** This is the normal preset state, in which both the amplitude and phase components of any DUT modulation appear on the display.

**[AMPLITUDE]** displays only the amplitude modulation (AM), as illustrated in Figure 10-42 (a).

**[PHASE]** displays only the phase modulation (PM), as shown in Figure 10-42 (b).

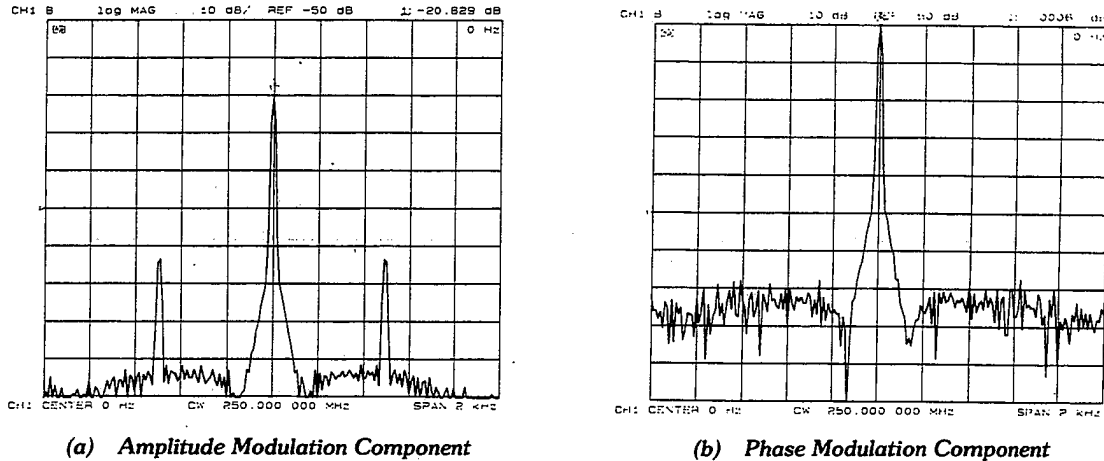

Figure 10-42. Separating the Amplitude and Phase Components of DUT-Induced Modulation

## Forward Transform Range

In the forward transform (from CW time to the frequency domain), range is defined as the frequency span that can be displayed before aliasing occurs, and is similar to range as defined for time domain measurements. In the range formula, substitute time span for frequency span.

Example:

$$\begin{aligned}
 \text{Range} &= (\text{Number of points} - 1) / \text{time span} \\
 &= (201 - 1) / (200 \times 10^{-3}) \\
 &= 1000 \text{ Hertz}
 \end{aligned}$$

For the example given above, a 201 point CW time measurement made over a 200 ms time span, choose a span of 1 kHz or less on either side of the center frequency (Figure 10-43). That is, choose a total span of 2 kHz or less.

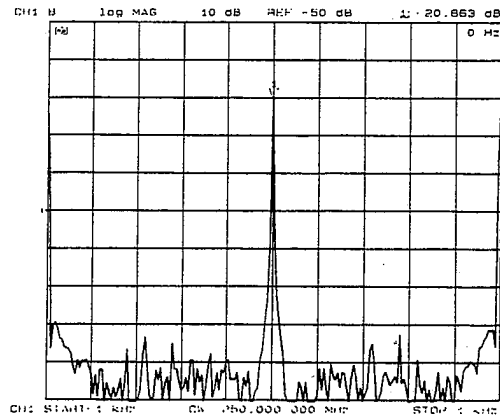

**Figure 10-43. Range of a Forward Transform Measurement**

To increase the frequency domain measurement range, increase the span. The maximum range is inversely proportional to the sweep time, therefore it may be necessary to increase the number of points or decrease the sweep time. Because increasing the number of points increases the auto sweep time, the maximum range is 2 kHz on either side of the selected CW time measurement center frequency (4 kHz total span). To display a total frequency span of 4 kHz, enter the span as 4000 Hz.

# PRINTING and PLOTTING MENUS

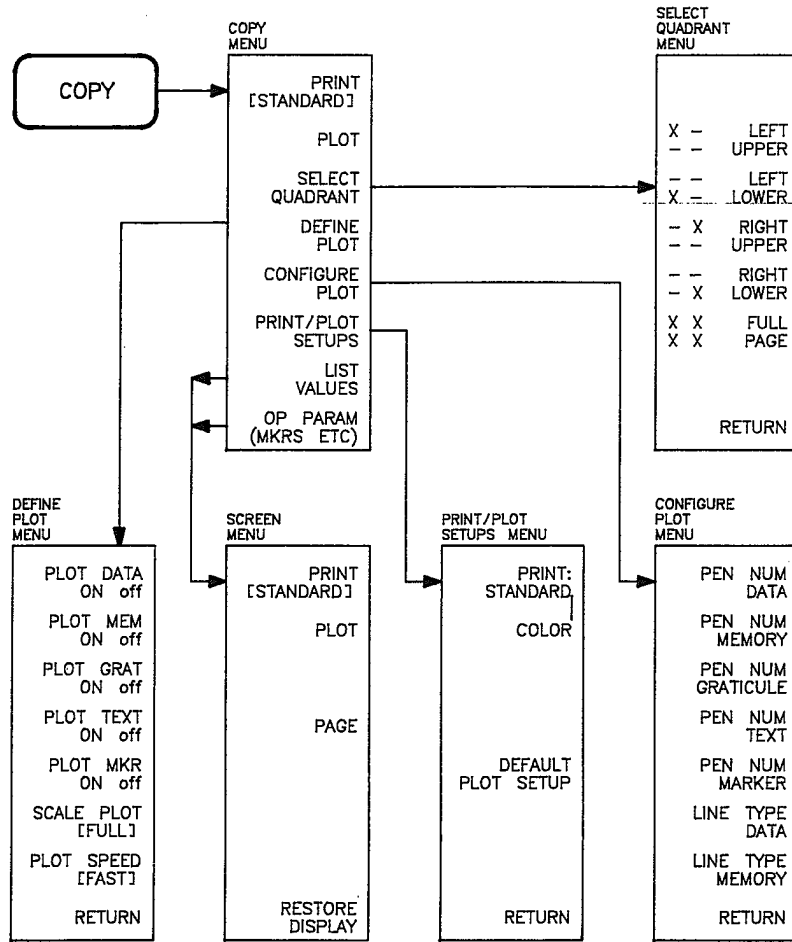

Refer to this foldout menu map as needed when using this tab section.

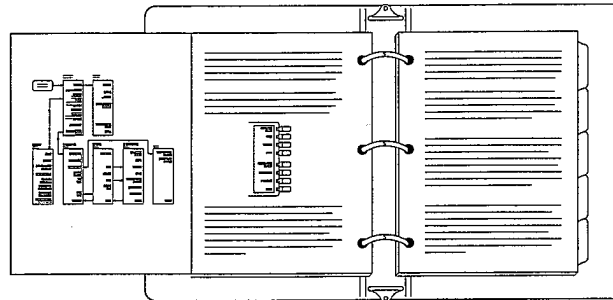

Figure 10-44. Softkey Menus Accessed from COPY Menu

# Printing and Plotting

## CONTENTS

10-73	Introduction
10-74	[COPY] Key
10-74	Copy Menu
10-76	Print/Plot Setups Menu
10-77	Select Quadrant Menu
10-78	Define Plot Menu
10-79	Configure Plot Menu
10-81	Screen Menu

## INTRODUCTION

### About Printing and Plotting, Where Compatible Printers and Plotters are Mentioned.

The analyzer can use HP-IB to output measurement results directly to a compatible printer or plotter, without the use of an external controller. The information shown on the display can be copied to a compatible Hewlett-Packard plotter or graphics printer. A plotter provides better resolution than a printer for data displays, while a printer provides higher speed for tabular listings. Refer to the *General Information* section of this manual for information about compatible plotters and printers.

**NOTE:** In the following text, "print" is sometimes used as a generic term for either printing or plotting. Similarly, "printout" is sometimes used as a generic term for either a printed or plotted image.

### Where to Find Tutorial Information

Tutorial information on how to plot or print is supplied in the *User's Guide*.

### Printing with or without a Computer Controller on the Bus

To generate a plot or printout from the front panel when there is no other controller on the bus, the analyzer must be in system controller HP-IB mode. If a computer controller is connected to the analyzer, the latter must take control from the computer to initiate a plot or printout. To do this, the analyzer must be in pass control mode, and a pass control command must be sent by the computer. The computer essentially gives the analyzer permission to control the bus.

If the analyzer is not the proper controller mode (system controller or pass control mode, as explained above), the message "SYST CTRL or PASS CTRL in LOCAL menu" is displayed. Refer to [LOCAL] Key at the beginning of Chapter 10 for information on HP-IB controller modes and setting addresses.

## Print/Plot Buffer

The instrument can continue operation while a printout is in progress. Press **[LOCAL]** to abort a printout before it is finished. If you attempt to print a second image before the first is finished, the message "PRINT/PLOT IN PROGRESS, ABORT WITH LOCAL" is displayed and the second attempt is ignored. An aborted printout cannot be continued: the process must be initiated again if a copy is still required.

## [COPY] KEY

The HP-IB programming command is shown in parenthesis following the key or softkey.

The **[COPY]** key provides access to the menus used for controlling external plotters and printers and defining the plot parameters.

## Copy Menu

Softkeys in the copy menu can copy the display to a printer or plotter without the need to access other menus. For user-defined plot parameters or color printing, a series of additional menus is available.

This menu also provides tables of operating parameters and measured data values, which can be copied from the display to a printer or plotter.

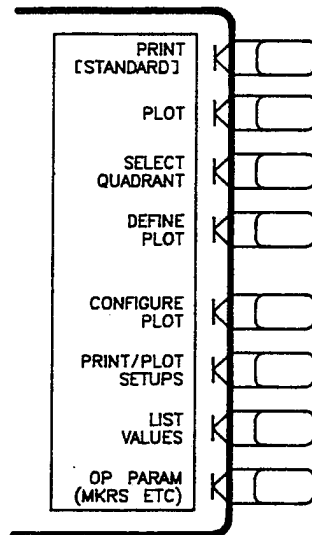

Figure 10-45. Copy Menu

When the print or plot function is engaged, the analyzer takes a "snapshot" of the display and sends it to the printer or plotter through a buffer. Once the data is transferred to the buffer, the analyzer is free to continue measurements while the data is printing.

**[PRINT [STANDARD]]** (PRINALL) identifies the printer selected in the print/plot setups menu: either **[STANDARD]** for a black and white printer or **[COLOR]** for a color printer. The default setting at power on is standard. When pressed, this softkey causes an exact copy of the display to be printed.



**[PLOT]** (PLOT) plots the display to a compatible HP graphics plotter, using the currently defined plot parameters (or default parameters). Any or all displayed information can be plotted, except the softkey labels and display listings such as the frequency list table or limit table. (List values and operating parameters can be plotted using the screen menu explained later in this chapter. However, this is considerably slower than printing.)

To achieve the fastest actual plotting time, place the analyzer in Hold mode (press **[MENU]** **[TRIGGER MENU]** **[HOLD]** ), make few or no pen changes, and limit complex functions such as averaging and calibration interpolation. The simplest configuration yields the fastest plot times.

**[SELECT QUADRANT]** leads to the the select quadrant menu, which provides the capability of drawing quarter-page plots. This is not available using a printer.

**[DEFINE PLOT]** leads to the define plot menu, which specifies which elements of the display are to be plotted. This is not used for printing.

**[CONFIGURE PLOT]** leads to the configure plot menu, which defines the pen number and line type for each of the plot elements. This is not used for printing.

**[PRINT/PLOT SETUPS]** presents the print/plot setups menu. This menu allows you to copy the display to a printer capable of a graphics plot. The analyzer is designed to be compatible with the HP 2225A ThinkJet, the HP 3630A PaintJet, and the HP 2227 QuietJet Plus. Other Hewlett-Packard printers may also be compatible with the analyzer, refer to "General Information" in the *Operating Manual*.

The printer speed may be slower when error correction, time domain functions, or other data processing functions are enabled.

**[LIST VALUES]** (LISV) provides a tabular listing of all the measured data points and their current values, together with limit information if it is turned on. At the same time, the screen menu is presented, which allows you to print each sequential page of the table. Thirty lines of data are listed on each page, and the number of pages is determined by the number of measurement points specified in the stimulus menu.

Up to five columns of data are provided. The specific information listed for each measured data point varies depending on the display format, the limit testing status, and whether or not dual channel display or stimulus coupling is selected. If limit testing is on, an asterisk \* is listed next to any measured value that is out of limits. If limit lines are on, and other listed data allows sufficient space, the limits are listed together with the margin by which the device data passes or fails the nearest limit.

**[OP PARAM (MKRS ETC)]** (OPEP) provides a tabular listing on the display of the key parameters for both channels. The screen menu is presented so you can print each individual page of the table. Four pages of information are supplied. These pages list operating parameters, marker parameters, lists and system parameters (the latter relates to control of peripheral devices rather than selection of measurement parameters).

## Print/Plot Setups Menu

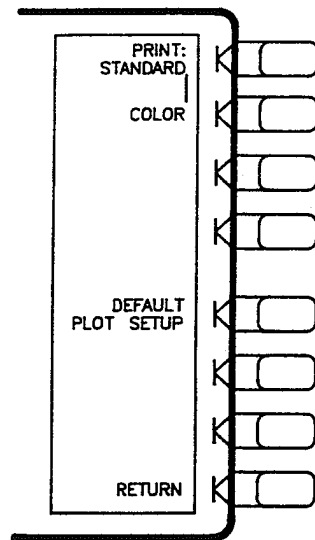

Figure 10-46. Print/Plot Setups Menu

**[PRINT: STANDARD]** (PRIS) sets the print default to black.

**[COLOR]** (PRIC) sets the print default to color. The colors used by the printer match the analyzer's default color values. The **[PRINT [COLOR]]** command does NOT work with a black and white printer.

**[DEFAULT PLOT SETUP]** (DFLT) resets the plotting parameters to their default values. These defaults are as follows:

- |                    |                       |               |           |           |
|--------------------|-----------------------|---------------|-----------|-----------|
| ● Select quadrant: | Full page.            | ● Pen numbers | Channel 1 | Channel 2 |
| ● Define plot:     | All plot elements on. | Data          | 1         | 2         |
| ● Plot scale:      | Full.                 | Memory        | 1         | 2         |
| ● Plot speed:      | Fast.                 | Graticule     | 3         | 4         |
| ● Line type:       | 7 (solid line).       | Text          | 1         | 2         |
|                    |                       | Marker        | 5         | 6         |

Default setups do not apply to printing.

**[RETURN]** goes back to the copy menu.

## Select Quadrant Menu

This menu offers the selection of a full-page plot, or a quarter-page plot in any quadrant of the page.

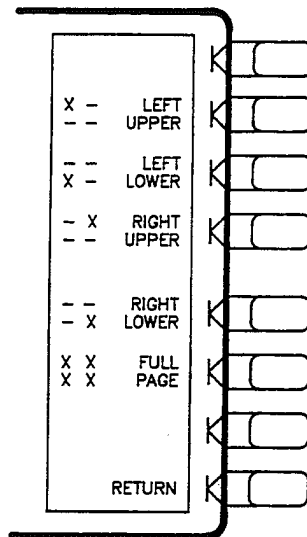

Figure 10-47. Select Quadrant Menu

**[LEFT UPPER]** (LEFU) draws a quarter-page plot in the upper left quadrant of the page.

**[LEFT LOWER]** (LEFL) draws a quarter-page plot in the lower left quadrant of the page.

**[RIGHT UPPER]** (RIGU) draws a quarter-page plot in the upper right quadrant of the page.

**[RIGHT LOWER]** (RIGL) draws a quarter-page plot in the lower right quadrant of the page.

**[FULL PAGE]** (FULP) draws a full-size plot according to the scale defined with **[SCALE PLOT]** in the define plot menu (described next).

**[RETURN]** goes back to the copy menu.

## Define Plot Menu

This menu allows selective plotting of display elements (graticule, markers, etc.). Different plot elements can be turned on or off as required. In addition, plot speed and plot scale may be changed to allow plotting on transparencies or preprinted forms.

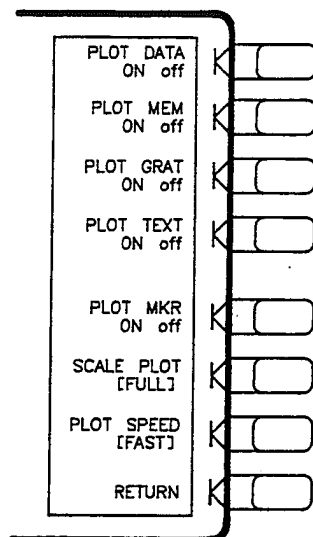

Figure 10-48. Define Plot Menu

**[PLOT DATA ON off]** (PDATAON, PDATAOFF) specifies whether the data trace is to be drawn (ON) or not drawn (OFF) on the plot.

**[PLOT MEM ON off]** (PMEON, PMEMOFF) specifies whether the memory trace is to be drawn (ON) or not drawn (OFF) on the plot. Memory can only be plotted if it is displayed (refer to *Display Menu* in Chapter 7).

**[PLOT GRAT ON off]** (PGRATON, PGRATOFF) specifies whether the graticule and the reference line are to be drawn (ON) or not drawn (OFF) on the plot. Turning **[PLOT GRAT ON]** and all other elements off is a convenient way to make preplotted grid forms. However, when data is to be plotted on a preplotted form, **[PLOT GRAT OFF]** should be selected.

**[PLOT TEXT ON off]** (PTEXTON, PTEXTOFF) selects plotting of all displayed text except the marker values, softkey labels, and display listings such as the frequency list table or limit table. (Softkey labels can be plotted under the control of an external controller. Refer to the *HP-IB Programming Guide*.)

**[PLOT MKR ON off]** (PMKRON, PMKROFF) specifies whether the markers and marker values are to be drawn (ON) or not drawn (OFF) on the plot.

**[SCALE PLOT]** (SCAPFULL, SCAPGRAT) provides two selections for plot scale, **[FULL]** and **[GRAT]**. **[FULL]** is the normal scale selection for plotting on blank paper, and includes space for all display annotations such as marker values, stimulus values, etc. The entire display fits within the user-defined boundaries of P1 and P2 on the plotter, while maintaining the exact same aspect ratio as the display.

With the selection of **[GRAT]**, the horizontal and vertical scale are expanded or reduced so that the graticule lower left and upper right corners exactly correspond to the user-defined P1 and P2 scaling points on the plotter. This is convenient for plotting on preprinted rectangular or polar forms (for example, on a Smith chart).

To plot on a rectangular preprinted graticule, set P1 of the plotter at the lower left corner of the preprinted graticule, and set P2 at the upper right corner.

To plot on a polar format, set P1 to either the left (or bottom) end point of a diameter and P2 to the right (or top) end point. The analyzer will then compute and set new P1 and P2 values to obtain the current circumference. If P1 and P2 are set to within 10% of already being a perfect square, the analyzer will not change the boundaries but will distort the circles to fit the user-defined boundaries.

The procedure for plotting on a Smith chart format depends on the plotter capabilities. Some HP plotters have a 90° rotate feature that enables plotting on a portrait (vertical) format rather than a landscape (horizontal) format. Since most Smith charts are printed in portrait format, this rotate feature should be used prior to setting the P1 and P2 points as described above for a polar format.

**[PLOT SPEED]** (PLOSFAST, PLOSSLOW) provides two plot speeds, **[FAST]** and **[SLOW]**. Fast is the proper plot speed for normal plotting. Slow is used for plotting directly on transparencies: the slower speed provides a more consistent line width. A color plot can be prepared directly on a transparency so that the color is not lost in converting a paper plot to a transparency.

**[RETURN]** goes back to the copy menu.

## **Configure Plot Menu**

This menu selects the pens to be used for plotting different display elements, and the line types for the data and memory traces.

Pen numbers 0 through 10 can be selected (0 indicates no pen). It is possible to select a pen number higher than the number of pens in the plotter used. The convention in most Hewlett-Packard plotters is that when the pen number count reaches its maximum number it starts again at 1. Thus in a 4-pen plotter, pen number 5 actually calls pen number 1.

The default pen numbers for the different plot elements vary between channels 1 and 2, so that when a color plotter is used the plots for the two channels can be identified quickly by their colors.

Line types 0 through 10 can be selected. The line types depend on the model of plotter used. In general, however, line type 0 specifies dots only at the points that are plotted; line types 1 through 6 specify broken lines with different spacing; and lines 7 through 10 are solid lines. Refer to the plotter manual for specific line type information.

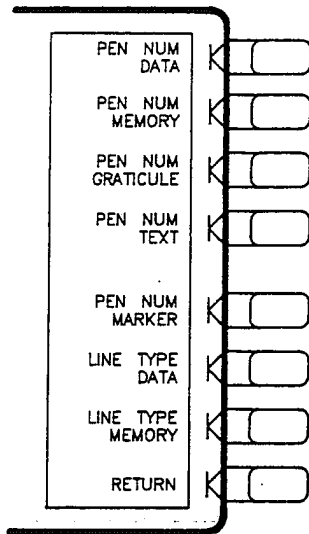

Figure 10-49. Configure Plot Menu

**[PEN NUM DATA]** (PENNDATA) selects the number of the pen to plot the data trace. The default pen for channel 1 is pen number 1, and for channel 2 is pen number 2.

**[PEN NUM MEMORY]** (PENMEMO) selects the number of the pen to plot the memory trace. The default pen for channel 1 is pen number 1, and for channel 2 is pen number 2.

**[PEN NUM GRATICULE]** (PENGRAT) selects the pen number for plotting the graticule. The default pen for channel 1 is pen number 3, and for channel 2 is pen number 4.

**[PEN NUM TEXT]** (PENTEXT) selects the pen number for plotting the text. The default pen for channel 1 is pen number 1, and for channel 2 is pen number 2.

**[PEN NUM MARKER]** (PENMARK) selects the pen number for plotting both the markers and the marker values. The default pen for channel 1 is pen number 5, and for channel 2 is pen number 6.

**[LINE TYPE DATA]** (LINTDATA) selects the line type for the data trace plot. The default line type is 7, which is a solid unbroken line.

**[LINE TYPE MEMORY]** (LINTMEMO) selects the line type for the memory trace plot. The default line type is 7.

**[RETURN]** goes back to the copy menu.

## Screen Menu

This menu is used in conjunction with the **[LIST VALUES]** and **[OP PARAM (MKRS etc)]** features, to print listings of the tables displayed on the screen.

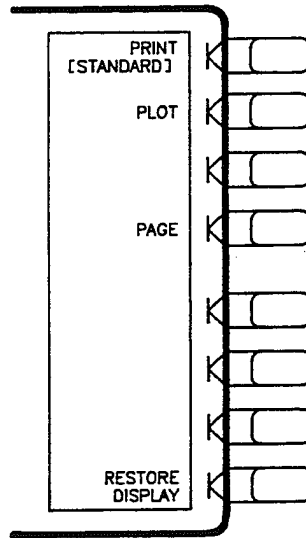

Figure 10-50. Screen Menu

**[PRINT [STANDARD]]** (PRINALL) copies one page of the tabular listings to a compatible HP graphics printer. Either **[STANDARD]** (for black) or **[COLOR]** (for color) is shown in brackets. This identifies which print type was selected as the default in the print/plot setups menu. The default setting at power on is STANDARD. Default text for a color printer is black.

**[PLOT]** (PLOT) plots one page of the tabular listing shown on the display.

**NOTE:** A printer will print tabular listings much faster than a plotter.

**[PAGE]** (NEXP) displays the next page of information in a tabular listing.

**[RESTORE DISPLAY]** (RESD) turns off the tabular listing and returns the measurement display to the screen.







# SAVE and RECALL MENUS

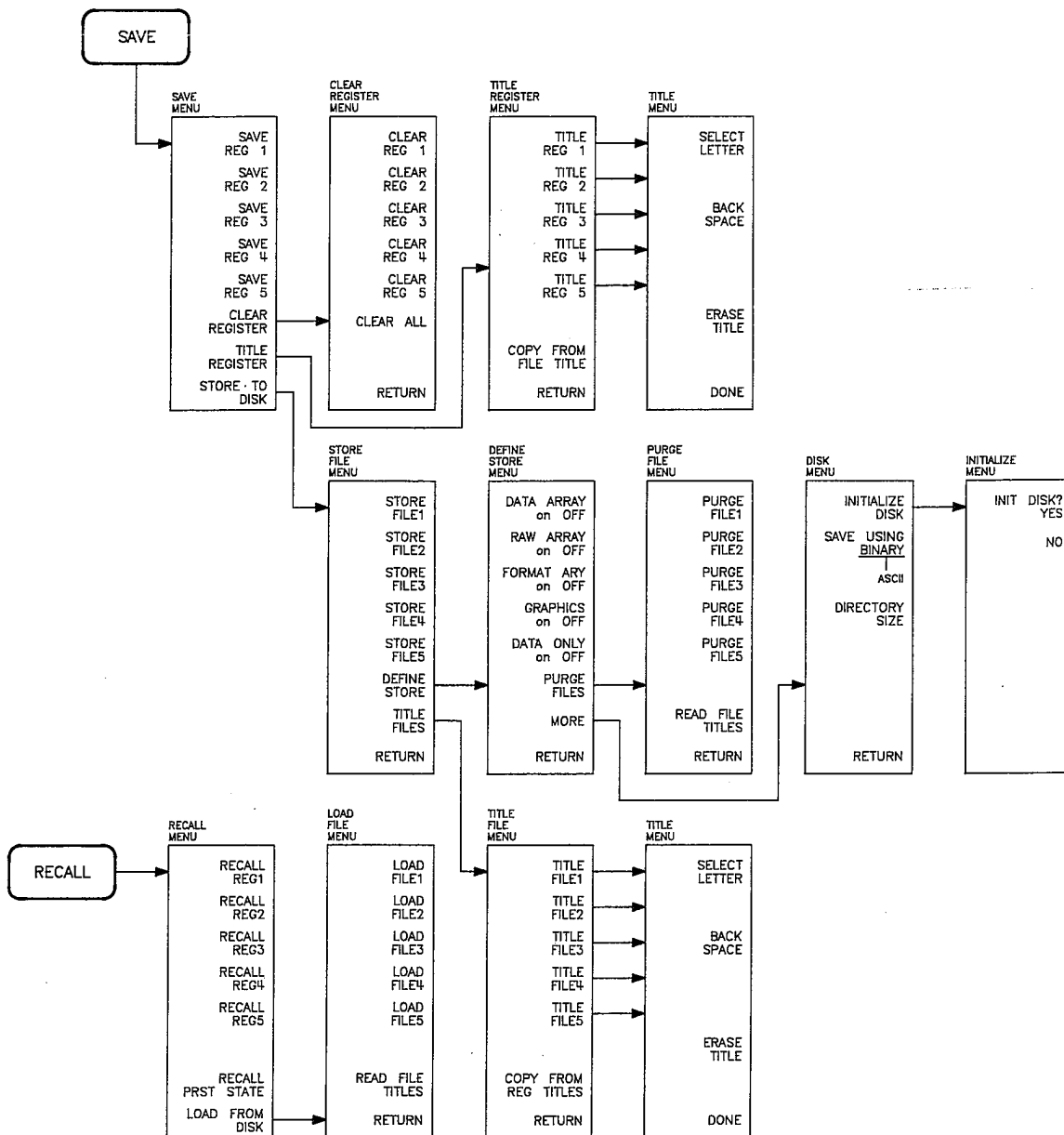

Refer to this foldout menu map as needed when using this tab section.

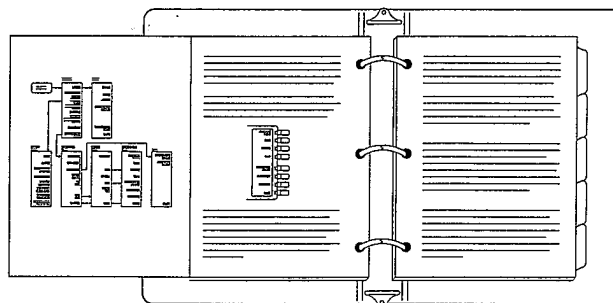

Figure 10-51. Softkey Menus Accessed from SAVE and RECALL Menus

# Save and Recall

## CONTENTS

10-86	What this section explains
10-86	Saving to internal memory
10-86	What is saved
10-87	Saving to disk
10-87	What information is saved by default
10-87	Optional information you can save to disk
10-87	Which external computers can read the analyzer's disks
10-87	Which network analyzers can read the HP 8752's data files
10-87	"Volatile" and "Non-Volatile" memory
10-88	Instrument states
10-88	<b>[SAVE]</b> and <b>[RECALL]</b> keys
10-88	Save and recall to internal memory
10-88	Save and recall to external disk
10-89	<b>[SAVE]</b> key menus
10-89	Save menu
10-90	Clear register menu
10-91	Title register menu
10-92	Title menu
10-93	Store file menu
10-94	Define store menu
10-97	Purge file menu
10-98	Disk menu
10-99	Initialize menu
10-100	Title file menu
10-101	<b>[RECALL]</b> key menus
10-101	Recall menu
10-102	Load file menu
10-105	Appendix to save and recall – CITIFile ASCII file format

## INTRODUCTION

Tutorial information on saving and recalling instrument information is provided in the *User's Guide*.

The analyzer has the capability of saving measurement settings, measurement data, and other types of information for later retrieval. It has five internal registers for this purpose, and can save to floppy disk as well.

## WHAT THIS SECTION EXPLAINS

### When Saving to Internal Memory

- What information is saved.
- How long does saved information last when power is turned off.

### When Saving to Disk

- What information is saved to disk by default.
- Optional information you can save to disk.
- Which external computers can read the analyzer's disks.

### About Test Sequences

The SAVE and RECALL keys do not save test sequences. Test sequences are saved to memory as soon as they are created. Only one, Sequence 6, will survive if power is turned off. Sequences have their own menus for saving and loading to/from disk. Refer to the Test Sequencing section for details.

## SAVING TO INTERNAL MEMORY

### What is Saved

The following information is saved to one of five internal memory registers:

Table 10-6. Data that is Saved to Internal Memory

Data Name	Description	Power-Off Life Storage
Instrument State	<p><b>Includes:</b></p> <p><b>All front panel settings</b> (the <i>Learn String</i>)</p> <p>The error correction data from the a measurement calibration is saved if the calibration feature is turned on.</p> <p>Trace memory data is saved if any of the trace memory functions are turned on.</p>	<p>At least 3 days</p> <p>None</p> <p>None</p>

## **SAVING TO DISK**

### **What Information Is Saved to Disk by Default**

Under default conditions, the same data the instrument saves to internal memory is saved to disk

### **Optional Information You Can Save to Disk**

The user can select which information is saved to disk. Any of the following types can be selected independently.

- Instrument State with calibration data along with memory trace. The define store menu allows you to turn off instrument state storage.
- Measurement data (known as a data array) at various stages of evolution (you can save the measurement data before or after error correction, for example). You must select one of the data arrays using the define store menu before the analyzer will save it to disk.
- User graphics can be saved to disk. Refer to "Define Store Menu" for instructions. User graphics can be created using the test sequencing feature, or using an external computer controller. The "Test Sequencing" section explains user graphics commands you can use without an external computer. Look near the end of that section under "HP-GL Considerations." Commands you can invoke from a computer are explained in the *HP-IB Quick Reference*.

The instrument state information can be "turned off" so it is not saved to disk. This saves disk space for users who are only interested in saving measurement data.

### **Which External Computers Can Read the Analyzer's Disks**

HP Series 9000 Model 200 or 300 computers can use these disks directly.

HP Vectra or PC Compatible computers do not use the same disk format as is used by the analyzer. (The analyzer uses LIF diskette format, PC-compatible computers do not.) There are ways of getting files onto PC-compatible diskettes: contact your local Hewlett-Packard sales and service office for information.

### **Which Network Analyzers Can Read the HP 8752's Data Files**

The data files saved to disk by the HP 8752 can only be read by other HP 8752s.

### **Volatile and Non-Volatile Memory.**

Both "volatile" and "non-volatile" memory mentioned in this chapter are actually temporary memory (RAM). The real difference between them is that volatile memory has no backup power source when line power is turned off, and data located there vanishes as soon as power is removed. Non-Volatile memory uses a capacitor which can supply backup power for at least 3 days. Data located there will survive for that amount of time.

## **INSTRUMENT STATES**

An instrument state consists of all the stimulus and response parameters that set up the analyzer to make a specific measurement. This part of the instrument state is called the *learn string* which, when saved, survives at least 3 days with power off. (Power sensor cal factor and loss tables are independent of the instrument state, although they too can survive at least 3 days with power removed.)

The learn string is an encoded array containing only the data needed to re-create the instrument state. For example, to re-create a frequency list the analyzer only needs to save the start frequency, frequency span, and number of points in each segment. Each point is not recorded. Thus the size of the learn string is not proportional to the number of points in the sweep

## **[SAVE] AND [RECALL] KEYS**

The **[SAVE]** key provides access to all the menus used for saving instrument states in internal memory and for storing to external disk. This includes the menus used to define titles for internal registers and external disk files, to define the content of disk files, to initialize disks for storage, and to clear data from the registers or purge files from disk.

The **[RECALL]** key leads to the menus that recall the contents of internal registers, or load files from external disk back into the analyzer.

## **SAVE AND RECALL TO INTERNAL MEMORY**

A maximum of five instrument states can be saved to internal memory registers. Up to 10 calibrations can be saved (five for each channel) at the end of the calibration procedure. Remember, however, that calibrations are lost when instrument power is turned off.

Calibration data is linked to the instrument state and measurement parameter for which the calibration was done. Therefore a saved calibration can be used for multiple instrument states as long as the measurement parameter, frequency range, and number of points are the same. When an instrument state is deleted from memory (see **[CLEAR REGISTER]**), the associated calibration data is also deleted

If a measurement is saved with calibration and interpolated calibration on, it will be restored with interpolated calibration on.

## **SAVE AND RECALL TO EXTERNAL DISK**

When the analyzer is in system controller mode or pass control mode, it can access an external CS80 disk drive such as the HP 9122. CS80 refers to the HP-IB I/O protocol used to control the drive. A description of what the analyzer stores to disk is supplied in "What is Stored", earlier in this section.

The analyzer shows an instrument state as a single filename, however, several files are actually stored to the disk. Thus, when the disk catalog is accessed from a remote system controller, the directory will show several files associated with a particular saved state. The maximum number of files that can be stored on a disk depends on the directory size: the default is 256. Refer to the *HP-IB Programming Guide* for further information.

Each type of disk file created by the analyzer ends with a unique one or two character suffix (This is used by an external controller for cataloging files, and is not visible on the front panel title display.) The first character is the file type and the second is a data index. The *HP-IB Quick Reference* explains the characters used in file name suffixes, and their meanings.

If correction is on at the time of an external store, the *calibration set* (error coefficient data) is stored to disk. (Calibrations that are turned off are not stored to disk.) When an instrument state is loaded into the analyzer from disk, the learn string is restored first. If correction is on for the loaded state, the analyzer will load a calibration set from disk that carries the same title as the one stored for the instrument state.

If an instrument state is stored with interpolated calibration on, the restored instrument state will then be interpolated.

**NOTE:** A calibration stored from one instrument and recalled by a different one will be invalid. To ensure maximum accuracy, always recalibrate in these circumstances

No record is kept in memory of the temperature when a calibration set was stored. Instrument characteristics change as a function of temperature, and a calibration stored at one temperature may be inaccurate if recalled and used at a different temperature. Refer to the *Specification* chapter for allowable temperature ranges for individual specifications.

## **[SAVE] KEY MENUS**

### **Save Menu**

This menu selects an internal memory register to store the current instrument state. If a register contains a previously saved instrument state, the softkey label changes to **[RESAVE]**. This is intended to prevent inadvertent destruction of saved states. Pressing **[RESAVE]** removes the contents of the register and saves the new instrument state.

This also leads to the series of menus for external disk storage.

The default titles for the save registers are REG1 through REG5, but these titles can be modified using the title register menu and the title menu.

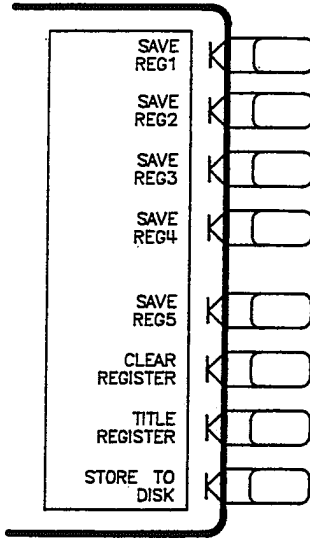

Figure 10-51A. Save Menu

**[SAVE REG1]** (SAVE1) through **[SAVE REG5]** (SAVE5) saves the current instrument state to one of the internal registers (REG1 through REG5).

**[CLEAR REGISTER]** leads to the clear register menu, described on the next page.

**[TITLE REGISTER]** leads to the title register menu, where the default register titles can be modified.

**[STORE TO DISK]** leads to the store file menu, which introduces a series of menus for disk storage.

### Clear Register Menu

This menu allows unused instrument states to be cleared from save registers, making the assigned memory available for other uses. When an instrument state is deleted from memory, the associated calibration set is also deleted. You can choose to selectively clear individual registers, or clear all registers with one keystroke.

Clearing of registers is performed internally with 100 alternating 0 and 1 rewrite operations over the entire non-volatile portion of the specified register memory.

Only registers that have instrument states previously stored in them are listed in this menu.



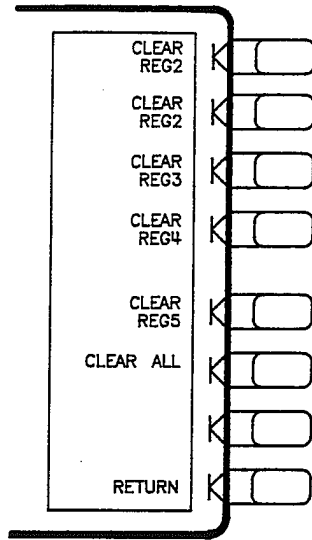

Figure 10-52. Clear Register Menu

**[CLEAR REG1]** (CLEA1) through **[CLEAR REG5]** (CLEA5) clears a previously saved instrument state from registers 1 through 5.

**[CLEAR ALL]** (CLEARALL) clears all instrument states.

**[RETURN]** goes back to the save menu.

### Title Register Menu

This menu can be used to select a register to be retitled. All registers are listed, regardless of whether or not they contain saved instrument states. When any of the title register softkeys is pressed, the title menu is presented and the character set is displayed in the active entry area.

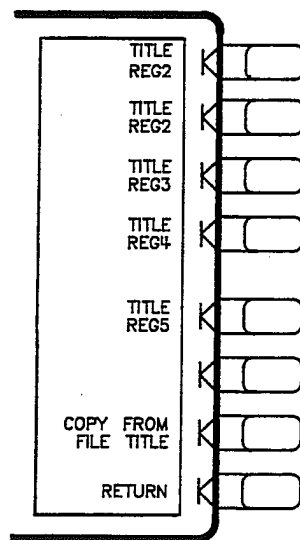

Figure 10-53. Title Register Menu

**[TITLE REG1]** (TITR1) through **[TITLE REG5]** (TITR5) selects which register is to be retitled and presents the title menu and the character set.

**[COPY FROM FILE TITLE]** (COPYFRFT) renames the internal registers to match the current store-to-disk file titles. For example, the default memory register titles are REG 1 through REG 5. Assume you have renamed the disk file titles to FILTER1 through FILTER5. Pressing **[COPY FROM FILE TITLE]** renames the memory registers to FILTER1 through FILTER5.

**[RETURN]** goes back to the save menu.

## Title Menu

Use this menu to define a title for the register selected in the title register menu. The title replaces the default register title in the softkey label, and is recalled with the saved instrument state.

The register title is limited to eight characters. If more than eight characters are selected, the last character is repeatedly written over. The title must be composed of letters and numbers, and must start with a letter. If the first character selected is not a letter, the message "CAUTION: FIRST CHARACTER MUST BE A LETTER" is displayed when the **[DONE]** key is pressed. No special characters or spaces are allowed. If a disallowed character is selected, the message "CAUTION: ONLY LETTERS & NUMBERS ARE ALLOWED" is displayed. (The special characters are used only for the display title, described in the Response chapter.)

The save register title is independent of the display title, which is also saved and recalled as part of the display.

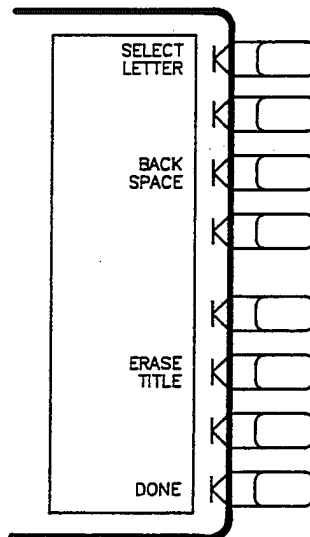



Figure 10-54. Title Menu

**NOTE:** When you first activate the title feature the Hewlett-Packard **[hp]** symbol may be in the existing title (look in the upper left-hand corner of the display). If desired, press **[ERASE TITLE]** to erase it before creating your title.

**[SELECT LETTER]**. The active entry area displays the letters of the alphabet, digits 0 through 9, and mathematical symbols. The mathematical symbols are not used in register titles. To define a title, rotate the knob until the arrow  points at the first letter, then press **[SELECT LETTER]**. Repeat this until the complete title is defined, for a maximum of eight characters. As each character is selected, it is appended to the title at the top left corner of the graticule.

**[BACK SPACE]** deletes the last character entered.

**[ERASE TITLE]** deletes the entire register title.

**[DONE]** terminates the title entry, and returns to the title register menu. The new title appears in the softkey label in all applicable menus.

## Store File Menu

This menu is used to store instrument states to an external disk rather than to internal memory registers. The analyzer can use HP-IB to store directly to a compatible disk drive, without the use of an external controller. Refer to the *General Information* section of this manual for information about compatible disk drives. Refer to the first part of this chapter for information about disk storage.

To store information on an external disk when there is no computer controller on the bus, the analyzer must be in system controller mode. If the analyzer is connected to an external computer, you must take control from the computer and initiate a store operation. To do this the analyzer must be in pass control mode, and you must issue a pass control command from the computer. This gives the instrument permission to temporarily take control of the HP-IB bus.

If the analyzer is not in system controller or pass control mode (as appropriate), the message "SYST CTRL OR PASS CTRL IN LOCAL MENU" is displayed. Refer to **[LOCAL]** Key (behind the Instrument State Block tab) for information on HP-IB controller modes and setting addresses.

If you attempt to store a file and the message "CAUTION: DISK: NOT ON, NOT CONNECTED, WRONG ADDR" is displayed, check the disk drive line power and HP-IB cable connection. Also make sure that the HP-IB address of the disk drive matches the address set in the address menu (refer to the *User's Guide* for setup instructions).

The default names for the stored files are FILE1 through FILE5. These file names can be modified using the title file menu.

**This analyzer's disks are incompatible with UNIX or PC compatible disk formats.** If a disk was formatted with another operating system such as UNIX or DOS, the analyzer will not read from it nor write to it. If a store operation is attempted with such a disk, the message "WRONG DISK FORMAT, INITIALIZE DISK" is displayed.



**Attempting to store to a UNIX or PC compatible diskette could destroy the directory on that disk, making any existing files on it unusable. THIS APPLIES TO HARD DISKS AS WELL!**

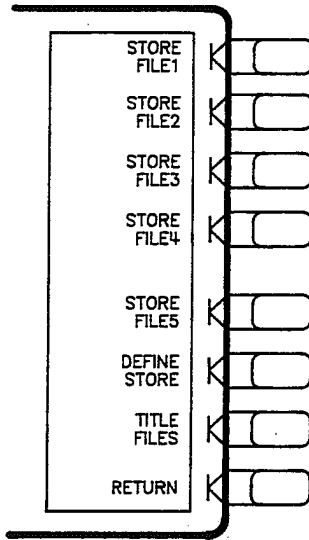

Figure 10-55. Store File Menu

**[STORE FILE1]** (STOR1) through **[STORE FILE5]** (STOR5) stores the current instrument state in the specified disk file (FILE1 through FILE5), together with any data specified in the define store menu. (The define store menu allows you to select specific data to be saved to disk, and is explained later in this chapter.)

**[DEFINE STORE]** leads to the define store menu. Use this menu to specify the data to be stored on disk in addition to the instrument state.

**[TITLE FILES]** leads to the title file menu, where the default file titles can be modified.

**[RETURN]** goes back to the save menu.

### Define Store Menu

Measurement data and user graphics can be stored on disk along with the basic instrument state. There are three types of data available when storing to disk (*raw data array*, *data array*, and *format array*). Each type of data comes from a different point along the instrument's data processing path. The table below shows how much signal processing has been done to the measurement data before it is saved in a given data array.

Table 10-7. Digital Processing Performed in the Raw Data Array, Data Array, and Format Array

	Processing Performed on Measured Signal	Resultant Data Array
Initial Measurement Steps	Real-time processing: Down-conversion to IF Analog/digital conversion IF detection Filtering Sampler/IF correction Averaging	Raw Data Array
Error Correction	Adds vector error correction (if turned on) to the Raw Data Array.	(error corrected) Data Array
Advanced Math	If turned on, these processing steps are added to the Data Array: Trace Memory/Math Gating Electrical delay Time domain transform Smoothing Conversion to scalar format	Format Array

You can save any or all of the above data arrays simultaneously. Refer to *Data Processing Flow* in Chapter 4 for more information about data arrays and the sequence of data processing events.

### If you intend to use (disk-stored) data files with an external computer or Hewlett-Packard's Microwave Design System (MDS)

Saving files to disk may be desired for several reasons. If your analyzer cannot be connected directly to a computer controller, you can transfer measurement data to your computer via diskette. Normally the analyzer saves instrument state information to disk, not measurement data. You can tell the analyzer to save measurement data as explained in the **[RAW ARRAY on OFF]**, **[DATA ARRAY on OFF]**, and **[FORMAT ARRAY on OFF]** softkey descriptions on the following page.

**Using (disk stored) data files with the Hewlett-Packard Microwave Design System.** To be compatible with MDS, you must choose CITIFile ASCII data format before saving your data files to disk. The analyzer is not normally in CITIFile mode, see the instructions on the following page changing to CITIFile.

**Manipulating (disk-stored) data files with an external computer controller.** CITIFile format is recommended for this use. CITIFile saves the stored measurement data in an easy to use ASCII format. CITIFile appends useful measurement information at the top of each file, followed by measurement data in simple ASCII format. The analyzer is not usually in CITIFile mode. refer to the instructions below for changing to CITIFile.

**Do you intend to transfer (disk-stored) data files to an external computer controller for archival purposes only?** If you are transferring disk files to a computer for archival purposes only, the default file format, *binary*, is useful.

**How to turn on CITIFile ASCII mode.** Press **[SAVE] [STORE TO DISK] [DEFINE STORE] [MORE] [ASCII]**. Pressing preset or turning power off takes the analyzer out of ASCII mode again. Using a save register will save instrument settings along with the CITIFile ASCII selection.

**Where to find more information on CITIFile ASCII.** The ASCII format is explained in more detail in the "Disk Menu", explained a little later in this chapter. More in-depth information is supplied at the end of this tab section.

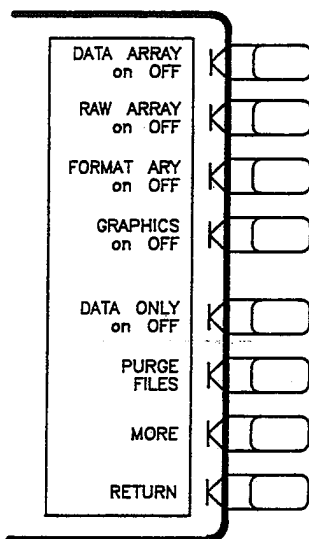

Figure 10-56. Define Store Menu

The following softkeys are listed in order of data processing sequence, rather than by appearance on the display.

**[RAW ARRAY on OFF]** (EXTMRAWON, EXTMRAWOFF) specifies whether or not to store the raw measurement data on disk. The only data processing performed at this point is averaging (if on). The raw data array is a series of complex (amplitude and phase) data pairs.

**[DATA ARRAY on OFF]** (EXTMDATAON, EXTMDATAOFF) specifies whether or not to store the error-corrected measurement data on disk. Since the data array is created from the raw array, averaging will also be included (if on). The data array is a series of complex data pairs.

**[FORMAT ARY on OFF]** (EXTMFORMON, EXTMFORMOFF) specifies whether or not to store the formatted data on disk. Signal processing at this stage includes trace math, gating, electrical delay, smoothing, and time domain. Since the format array is created from the data array, averaging (if on) and error correction (if on) are also included. *Formatted data is stored in scalar (amplitude only) format, not as complex (phase and amplitude) data pairs. Complex data pair information cannot be calculated from formatted (scalar) data.*

**[GRAPHICS on OFF]** (EXTMGRAPON, EXTMGRAPOFF) specifies whether or not to store display graphics on disk.

**[DATA ONLY on OFF]** stores only the selected Data Array to disk. The instrument state (composed of instrument settings, calibration data and memory trace) are not stored. This is faster than storing with the instrument state, and uses less disk space. It is intended for use in archiving data that will later be used with an external controller, and cannot be read back by the analyzer.

**[PURGE FILES]** leads to the purge files menu, which is used to remove the information stored on an external disk.

**[MORE]** leads to the disk menu, where additional parameters are defined for storing to disk. This in turn leads to the initialize menu.

**[RETURN]** goes back to the store file menu.

## Purge File Menu

This menu is used to remove (purge) stored information from a disk. When the purge file menu is entered, the file titles currently in analyzer memory are displayed. (File titles are stored in non-volatile memory.) These titles may or may not reside on the disk currently being used. The file titles can be updated to match the files on disk by reading the disk's directory with the **[READ FILE TITLES]** key.

The purge file menu is the external storage equivalent of the clear register menu.

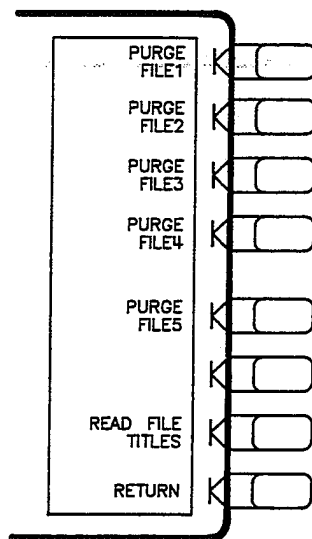

Figure 10-57. Purge File Menu

**[PURGE FILE1]** (PURG1) through **[PURGE FILE5]** (PURG5) purges the specified file (FILE1 through FILE5) from the disk. If no file of that name exists on the disk, the message "CAUTION: NO FILE(S) FOUND ON DISK" will appear

**[READ FILE TITLES]** (REFT) searches the directory of the disk for file names recognized as belonging to an instrument state, and displays them in the softkey labels. No more than five titles are displayed at one time. If there are more than five, repeatedly pressing this key causes the next five to be displayed. If there are fewer than five, the remaining softkey labels are blanked.

**[RETURN]** goes back to the define store menu.

## Disk Menu

This menu provides additional parameters for defining disk storage. Use this menu to select either *binary* or *CITIFile ASCII* data file format.

- **Binary** format is more compact than the CITIFile ASCII format, and is optimum when you do not plan to use the data disk with an external computer.
- **CITIFile ASCII** format is required if you wish to have an external computer controller use your measurement data (array) files. Compatible computers are mentioned at the beginning of this chapter.

CITIFile ASCII format places the following data in ASCII format, making it easily accessible when used on an external computer:

- Part of the learn string (stimulus type, number of points, and more).
- Raw, Corrected, and Format data array information.
- Calibration data and trace memory.

The following data remains in binary format, even when CITIFile is selected:

- Learn string data not mentioned above.
- Calibration kit data.
- User Graphics data

## Where to Find In-Depth CITIFile information

An appendix at end of this chapter contains detailed description of CITIFile format, including an example BASIC program that reads and prints CITIFile data.

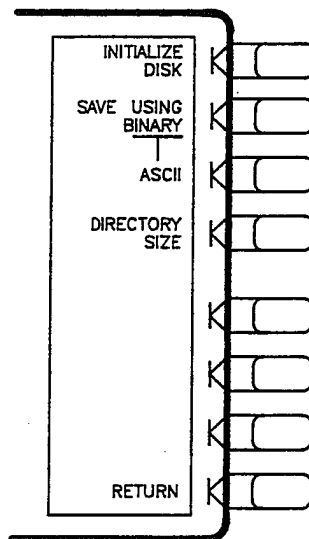

Figure 10-58. Disk Menu



**[INITIALIZE DISK]** leads to the initialize menu. A disk must be initialized before data can be stored on it. Instructions are provided in the *User's Guide*. You may also initialize a disk using an HP Series 9000 Model 200 or 300 computer. For optimum speed, specify an interleave factor of 7.

**[SAVE USING BINARY]** (SAVUBINA) selects binary file format for disk files.

**[ASCII]** (SAVUASCII) selects CITIFile ASCII format for disk files. This format can be understood by compatible external computer controllers, which are mentioned in the beginning of this chapter.

**[DIRECTORY SIZE]** lets you specify the number of directory files to be initialized on a disk. This is particularly useful with a hard disk, where you may want a directory larger than the default 256 files. Or with a floppy disk you may want to reduce the directory to allow extra space for data files. The number of directory files must be a multiple of 8. The minimum number is 8, and there is no practical maximum limit. Set the directory size before initializing a disk.

**[RETURN]** goes back to the define store menu.

## Initialize Menu

Initializing a disk prepares it to store data. This instrument initializes disks using LIF (logical interchange format) to provide compatibility with HP 9000 Model 200 and 300 computers. Also, a disk initialized on a model 200 or 300 computer will work with the analyzer. The recommended interleave factor is 7. Either the Hewlett-Packard black or gray double-sided disks can be used with the HP 9122 disk drive: if high transfer speed is a consideration, gray is recommended.

Disks initialized on the analyzer cannot be read by UNIX or PC compatible computers.

Initializing a disk removes all existing data. When this menu is presented, the message "INIT DISK removes all data from disk" is displayed. If other error messages are encountered, refer to *Error Messages* for help.

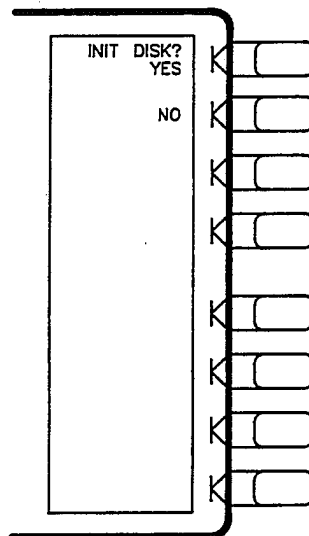

Figure 10-59. Initialize Menu

**[INIT DISK? YES]** initializes the disk in the previously-designated unit number and volume number. Unit number refers to the specific drive slot (0 or 1), volume number specifies a hard disk partition (a partition is also called a volume). If more than one hard disk partition is to be initialized, each must be selected and initialized individually.

During the initialization process, the message "WAITING FOR DISK" is displayed: this is normal. If the disk is damaged, the message "INITIALIZATION FAILED" is displayed.

**[NO]** leaves this menu without initializing the disk, and returns to the disk menu.

## Title File Menu

This menu selects a disk file to be retitled. Changing the title is useful for saving a file under your own filename, or when recalling a specific file.

For example, you want to load a file called "FILTER1" that you know is on a certain disk. The disk has dozens of files on it and you don't want to read file titles to find it. You could change one of the softkey titles (for example "FILE1") to "FILTER1". Then you could press **[LOAD FILTER1]** and the desired file would be found and loaded. This feature is helpful when loading, saving, or purging disk files, and is most useful with disks that contain many files.

When the softkey for the selected file is pressed, the title menu is presented and the character set is displayed in the active entry area. The title menu is described earlier in this chapter. The same restrictions apply to file titles as to internal register titles: that is, a file title is limited to eight characters, must be composed of letters and numbers, and must begin with a letter.

A file title defined with the title menu replaces the default file title in the softkey label, and is stored to disk with the corresponding file.

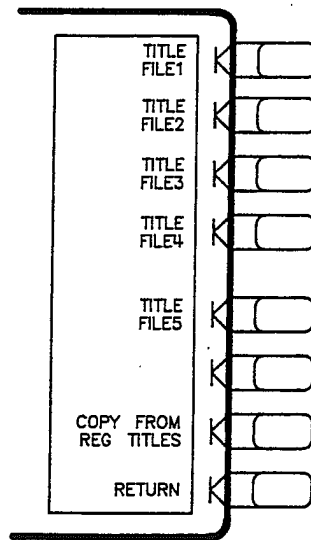

Figure 10-60. Title File Menu

**[TITLE FILE1]** (TITF1) through **[TITLE FILE5]** (TITF5) selects one of the five softkey labels (FILE1 through FILE5) to be retitled, and leads to the title menu.

**[COPY FROM REG TITLES]** This key renames the store-to-disk file titles to match the names of the internal memory registers. (It does not alter the names of any files already stored to disk).

For example, the default names of the disk storage files are FILE1 through FILE5. Assume assume you renamed the five internal memory registers to FILTER1 through FILTER5. Pressing **[COPY FROM REG TITLES]** renames the softkey labels FILTER1 through FILTER5.

**[RETURN]** goes back to the store file menu.

## **[RECALL] KEY MENUS**

### **Recall Menu**

This menu is used to recall instrument states from internal memory. It also brings up the load file menu, which loads files from external disk.

When the recall menu is displayed, only the names of registers containing instrument states are displayed in the top five softkey labels. Any register that does not currently contain a saved instrument state has its softkey label blanked.

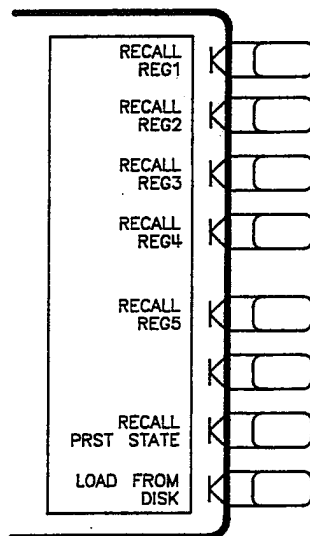

*Figure 10-61. Recall Menu*

**[RECALL REG1]** (RECA1) through **[RECALL REG5]** (RECA5) recalls the instrument state saved in the selected register (REG1 through REG5). The instrument implements the recalled state immediately.

**[RECALL PRST STATE]** is entered when creating a sequence. It returns the instrument to preset settings during sequence operation. (Pressing **[PRESET]** when creating a sequence would preset the instrument immediately and ruin the sequence you are creating!). The command is not identical to the **[PRESET]** key in that it waits until the sequence is run before presetting the instrument. In addition, no preset tests are run, and the HP-IB and sequencing activities are not changed.

**[LOAD FROM DISK]** accesses the load file menu. Use this menu to restore instrument states previously stored to disk.

## Load File Menu

This menu is used to search the directory of a disk and restore previously stored instrument state files

**There are three ways to locate a file on disk:**

1. The analyzer remembers the names of the last five files it previously found on any disk. (File titles are stored in non-volatile memory.) Therefore, when you enter this menu, the file titles in memory will appear in the top five softkeys, whether or not they reside on the disk currently in the drive.
2. The **[READ FILE TITLES]** key in this menu causes the analyzer to search the directory of the current disk and display any file titles recognized as compatible. Only five titles are displayed at a time.
3. From the store file menu, use the **[TITLE FILES]** key to title a softkey with the name of the file you want to load. Return to the load file menu. The title you just created will appear in one of the load file softkey labels. Press that softkey. If the file does not exist, the message "CAUTION: NO FILE(S) FOUND ON DISK" will be displayed. This method is useful only if you know the exact name of the instrument state to be loaded. Using **[READ FILE TITLES]** is a more efficient method of finding file names, unless a large number of instrument states has been stored to the disk.

**Compatibility with UNIX or PC compatible diskette format.** The analyzer cannot read from, or write to, disks formatted on a UNIX or PC compatible computer. It can read disks formatted on another HP 8700 family vector network analyzer, or on an HP 9000 Series 200 or 300 computer. If using HP-UX the LIF Utilities can transfer files to other diskette formats.

**Compatible Network Analyzer Data Files.** The HP 8752 can only read files created by itself or another HP 8752.

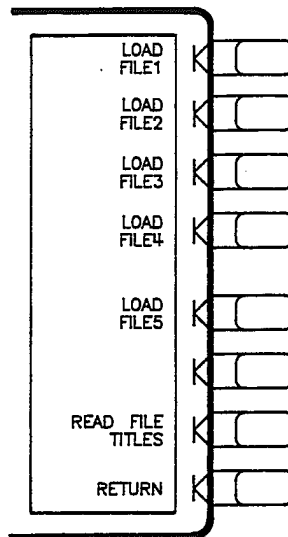

*Figure 10-62. Load File Menu*

**[LOAD FILE1]** (LOAD1) through **[LOAD FILE5]** (LOAD5) restore the instrument state contained in the selected file (FILE1 through FILE5). The current instrument state is overwritten.

**[READ FILE TITLES]** (REFT) searches the directory of the disk for file names recognized as belonging to an instrument state. No more than five titles are displayed at one time. If there are more than five, repeatedly pressing this key causes the next five to be displayed. If there are fewer than five, the remaining softkey labels are blanked.

**[RETURN]** goes back to the recall menu.



# Appendix to Save and Recall CITIFILE ASCII File Format

## INTRODUCTION

This is a short description of the Common Instrumentation Transfer and Interchange File (CITIFile) format used by Hewlett-Packard network analyzers. This format provides a common format for exchanging data between the analyzer, external computer controllers, and the HP Microwave Design System (MDS).

## WHEN TO USE CITIFILE

CITIFile is useful under the following circumstances:

- You must transfer disk files for use with Hewlett-Packard's MDS system.
- You use diskettes to transfer data array information to an external computer controller, and wish to manipulate this data.

## DESCRIPTION

With CITIFile format activated, selected data arrays, calibration data, and trace memory data can be stored to disk in ASCII format. In addition, certain instrument state information in CITIFile format, including sweep type and number of points.

CITIFile uses only standard ASCII text format files. ASCII provides a standardized, highly transportable type of file that may be created, examined, and edited using many applications, including HP BASIC. This makes it easy to pass information between hardware and software applications.

A CITIFile disk file is made up of one or more CITIFile *packages*. Each package begins with the CITIFile keyword, followed by individual lines made up of ASCII characters. Each line is terminated by carriage return/line feed.

Each file is terminated with a standard disk End-of-File (EOF).

## CITIFile Package Structure

The typical CITIFile package structure is:

CITIFile title line Name. Target device information.	<i>Title</i>
Constant declaration. Independent variable declaration. Dependent variable declaration. Independent variable list.	<i>Header</i>
Dependent variable list, or lists.	<i>Data List, or Lists</i>

As seen above, a package consists of a *header* and at least one list of data values. The header consists of the required CITIFile title line and optional information such as file name, instructions and data for the target application. The header also includes required declarations and data lists for the independent variable (usually frequency), and declarations for the dependent variables (the measured data). The remaining part of the file contains values for the dependent variable (the data value at each frequency point).

The following example shows a CITIFile disk file created by storing a DATA ARRAY (corrected data) to disk. To interpret the data, refer to the *HP-IB Quick Reference*. The CITIFile keywords are shown in bold type.

Example 1. HP 8752A Data Array File

```

CITIFILE A.01.00                               Package Title
#NA VERSION HP8752A.01.00
NAME DATA
VAR FREQ MAG 201
DATA S[1,1] RI                                 Header
SEG LIST BEGIN
SEG 100000000 1300000000 201
BEGIN
8.6303E-1,-8.98651E-1                             Dependent Variable Data List
8.5849E-1,3.06091E-1
-4.96887E-1,7.87323E-1
.
.
.
-5.65338E-1,-7.05291E-1
8.94287E-1,-4.255537E-1
1.77551E-1,8.96606E-1
END

```

In this case the analyzer was operating in the linear sweep mode, from 1 to 1.3 GHz, using 201 data points. The actual data file would contain 201 entries, one for each data point.

## EXAMPLE PROGRAM TO READ AND PRINT CITIFILE

The following is a simple BASIC program to read the contents of a CITIFile generated by the analyzer.

```

10 ALLOCATE Filename$(30), Current_line$(256), Response$(30)
20 PRINTER IS 1
30 LINPUT "Name of File to Read?",Filename$
40 ASSIGN @Diskfile to Filename$
50 ON END @Diskfile GOTO End_of_file
60 PRINT "**** DISK FILE NAME: ' "&Filename$&"' ****"
70 REPEAT
80 ENTER @Diskfile;Current_line$
90 PRINT Current_line$
100 UNTIL 0=1
110 End_of_file:
120 PRINT "**** END OF FILE ****"
130 END

```



## **WHERE TO FIND MORE CITIFILE INFORMATION**

Contact your nearest Hewlett-Packard sales office for more details on CITIFile data format.

## Preset Key

When the [PRESET] key is pressed, the analyzer reverts to a known state. This state is defined in Table 10-8, below. There are subtle differences between the preset state and the power-up state. These differences are documented in Table 10-9. If power to non-volatile memory is lost, certain parameters will be set to default settings. Table 10-10 shows the affected parameters.

When line power is cycled, or the [PRESET] key pressed, the analyzer performs a self-test routine. Upon successful completion of that routine, the instrument state is set to the following preset conditions. The same conditions are true following a "PRES;" or "RST;" command over HP-IB, although the self-test routines are not executed.

Table 10-8. Preset Conditions (1 of 2)

Operating Parameter	Preset Value	Operating Parameter	Preset Value
<b>Stimulus Conditions</b>			
SWEEP TYPE	linear frequency		
DISPLAY MODE	start/stop		
TRIGGER TYPE	continuous		
EXTERNAL TRIGGER	off		
SWEEP TIME	auto mode		
START FREQUENCY	.300 MHz		
STOP FREQUENCY	1300 MHz (3 GHz with option 003)		
START TIME	0		
TIME SPAN	100 milliseconds		
CW FREQUENCY	1000 MHz	BEEPER: DONE	on
TEST PORT POWER	-10 dBm	BEEPER: WARNING	off
POWER SLOPE	0 dB/GHz; off	D2/D1 TO D2	off
START POWER	-5.0 dBm	TITLE	channel 1 = [hp] channel 2 = empty
POWER SPAN	5 dB	NUMBER OF POINTS	201
COUPLED POWER	on	IF BANDWIDTH	3000 Hz
POWER TRIP	off	IF AVERAGING FACTOR	16; off
COUPLED CHANNELS	on	SMOOTHING APERTURE	1% SPAN; off
<b>Frequency List</b>		PHASE OFFSET	0 degrees
FREQUENCY LIST	empty	ELECTRICAL DELAY	0 seconds (all parameters)
EDIT MODE	start/stop, number of points	<b>Calibration</b>	
<b>Response Conditions</b>		CORRECTION	off
PARAMETER	channel 1: Reflection; channel 2: Transmission	CALIBRATION TYPE	none
CONVERSION	off	CALIBRATION KIT	Type-N
FORMAT	log magnitude (all inputs)	SYSTEM Z0	50 ohms (HP 8752A) 75 ohms (HP 8752B)
DISPLAY	data	VELOCITY FACTOR	1
COLOR SETTINGS	same as before	EXTENSIONS	off
DUAL CHANNEL	off	REFLECTION PORT	0
ACTIVE CHANNEL	channel 1	TRANSMISSION PORT	0
FREQUENCY BLANK	disabled		
SPLIT DISPLAY	on		
INTENSITY	If set to $\geq 15\%$ , [PRESET] has no effect. If set to $< 15\%$ , [PRESET] increases intensity to 15%.		

Table 10-8. Preset Conditions (2 of 2)

Operating Parameter	Preset Value	Operating Parameter	Preset Value			
<b>Calibration (Cont'd)</b>		<b>External Memory Array (Define Store)</b>				
ALTERNATE RFL & TRN	off	RAW DATA	off			
CHOP RFL & TRN	on	CORRECTED DATA	off			
INTERPOLATED ERROR CORRECTION	off	FORMATTED DATA	off			
<b>Markers (coupled)</b>		GRAPHICS	off			
MARKERS 1,2,3,4	1 GHz; all markers off	DATA ONLY	off			
LAST ACTIVE MARKER	1	DIRECTORY SIZE	256 files			
REFERENCE MARKER	none	<b>Sequencing<sup>2</sup></b>				
MARKER MODE	continuous	LOOP COUNTER	0			
DELTA MARKER MODE	off	<b>Service Modes</b>				
COUPLING	on	HP-IB DIAGNOSTIC	off			
DISP MKRS	on	SOURCE PHASE LOCK LOOP	on			
MARKER SEARCH	off	SAMPLER CORRECTION	on			
MARKER TARGET VALUE	-3 dB	SPUR AVOIDANCE	on			
MARKER WIDTH VALUE	-3 dB; off	AUX INPUT RESOLUTION	low			
MARKER TRACKING	off	ANALOG BUS NODE	11 (aux input)			
MARKER STIMULUS OFFSET	0	<b>Print</b>				
MARKER VALUE OFFSET	0	PRINT TYPE	last active state			
MARKER AUX OFFSET (PHASE)	0 degrees	<b>Plot</b>				
MARKER STATISTICS	off	PLOT DATA	on			
POLAR MARKER	LIN MKR	PLOT MEMORY	on			
SMITH MARKER	R+jX	PLOT GRATICULE	on			
<b>Limit Lines</b>		PLOT TEXT	on			
LIMIT LINES	off	PLOT MARKER	on			
LIMIT TESTING	off	PLOT QUADRANT	FULL PAGE			
LIMIT LIST	empty	SCALE PLOT	FULL			
EDIT MODE	upper/lower limits	PLOT SPEED	FAST			
STIMULUS OFFSET	0 Hz	<b>Plot (Cont'd)</b>				
AMPLITUDE OFFSET	0	PEN NUMBER:	Channel 1	Channel 2		
LIMIT TYPE	sloping line	Data	1	2		
BEEP FAIL	off	Memory	1	2		
<b>Time Domain</b>		Graticule	3	4		
TRANSFORM	off	Text	1	2		
TRANSFORM TYPE	bandpass	Marker	5	6		
TRANSFORM TYPE	bandpass	LINE TYPE				
START TRANSFORM	-20 nanoseconds	Data, Memory	7	7		
TRANSFORM SPAN	40 nanoseconds					
GATING	off					
GATE SHAPE	normal					
GATE START	-10 nanoseconds					
GATE SPAN	20 nanoseconds					
DEMODULATION	off					
WINDOW	normal					
USE MEMORY	off					
<b>System Parameters</b>		<b>Format Table</b>	<b>Scale</b>	<b>Reference</b>		<b>Marker Offset</b>
HP-IB ADDRESSES	last active state			<b>Position</b>	<b>Value</b>	
HP-IB MODE	last active state	LOG MAGNITUDE (dB)	10.0	5.0	0.0	0.0
INTENSITY	last active state	PHASE (degree)	90.0	5.0	0.0	0.0
		GROUP DELAY (ns)	10.0	5.0	0.0	0.0
		SMITH CHART	1.00	—	1.0	0.0
		POLAR	1.00	—	1.0	0.0
		LINEAR MAGNITUDE	0.1	0.0	0.0	0.0
		REAL	0.2	5.0	0.0	0.0
		IMAGINARY	0.2	5.0	0.0	0.0
		SWR	1.00	0.0	1.0	0.0

1. The power sensor calibration data and power loss tables are not affected by preset or by cycling line power.

2. Pressing preset turns off sequencing modify (edit) mode and stops any running sequence.

*Table 10-9. Power-on Conditions (versus Preset)*

HP-IB MODE: Talker/listener.

SAVE REGISTERS: Memory, error correction data, and power meter calibration data in save registers are cleared.

COLOR DISPLAY: Default color values.

INTENSITY and FOCUS: These values are set to factory encoded values. The factory values can be changed by running the appropriate service routine. Refer to the "Troubleshooting Reference" section of the service manual.

SEQUENCES: Sequences 1 through 5 are erased, 6 is retained.

*Table A-3. Results of Power Loss to Non-Volatile Memory*

HP-IB ADDRESSES are set to the following defaults:

HP 8752 .....	16
USER DISPLAY .....	17
PLOTTER .....	5
PRINTER .....	1
POWER METER .....	13
DISK DRIVE .....	0
DISK UNIT NUMBER (Drive 0 or 1) .....	0
DISK VOLUME NUMBER (Hard Disk Partition) .....	0

POWER METER TYPE is set to HP 438/437A

INTERNAL REGISTER TITLES are set to defaults: REG1 through REG5.

EXTERNAL REGISTER TITLES (store files) are set to defaults: FILE1 through FILE5.

PRINTER TYPE: Standard

## Chapter 12. Error Messages

---

When displayed, error messages are usually preceded with the word CAUTION:. That part of the error message has been omitted here for the sake of brevity. Some messages are for information only, and do not indicate an error condition. Two listings are provided: the first is in alphabetical order, and the second in numerical order.

In addition to error messages, instrument status is indicated by status notations in the left margin of the display. Examples are “\*,” and “P↓.” Sometimes these appear in conjunction with error messages. A complete listing of status notations and their meanings is provided in Chapter 5, “Front and Rear Panel.”

### ERROR MESSAGES IN ALPHABETICAL ORDER

**ADDITIONAL STANDARDS NEEDED** (error #68). Error correction for the selected calibration class cannot be computed until all the necessary standards have been measured.

**ADDRESSED TO TALK WITH NOTHING TO SAY** (error #31). An enter command was sent to the analyzer without first requesting data with an appropriate output command (such as OUTPDATA). The analyzer has no data in the output queue to satisfy the request.

**AVERAGING INVALID ON NON-RATIO MEASURE** (error #13). This error occurs only in single-input measurements. Sweep-to-sweep averaging is valid only for ratioed measurements (A/R, B/R, and A/B. Refer to “[AVG] Key” in Chapter 7 for a discussion of trace smoothing and variable IF bandwidths.

**BLOCK INPUT ERROR** (error #34). The analyzer did not receive a complete data transmission. This is usually caused by an interruption of the bus transaction. Clear by pressing the [LOCAL] key or aborting the IO process at the controller.

**BLOCK INPUT LENGTH ERROR** (error #35). The length of the header received by the analyzer did not agree with the size of the internal array block. Refer to the *HP-IB Programming Guide* for instructions on using analyzer input commands.

**CALIBRATION ABORTED** (error #74). The calibration in progress was terminated due to change of the active channel.

**CALIBRATION REQUIRED** (error #63). A calibration set could not be found that matched the current stimulus state or measurement parameter. Refer to “Measurement Calibration.” Calibration sets can be saved in internal or external memory. Refer to the “Save and Recall” section.

**CAN'T CHANGE-ANOTHER CONTROLLER ON BUS** (error #37). The analyzer cannot assume the mode of system controller until the active controller is removed from the bus or relinquishes the bus.

**CAN'T STORE/LOAD SEQUENCE, INSUFFICIENT MEMORY** (error #127). A sequence transfer to or from an external disk could not be completed because of insufficient memory.

**CH1 (CH2) TARGET VALUE NOT FOUND** (error #159). The target value for the marker search function does not exist on the current data trace.

**CORRECTION CONSTANTS NOT STORED** (error #3). A store operation to the EEPROM was not successful. The position of the jumper on the A9 CPU assembly must be changed. Refer to "A9 CC Jumper Position Procedure" in the "Adjustments and Correction Constants" section of the *Service Manual*.

**CORRECTION TURNED OFF** (error #66). Critical parameters in the current instrument state do not match the parameters for the calibration set, therefore correction has been turned off. The critical instrument state parameters are sweep type, start frequency, frequency span, and number of points.

**CURRENT PARAMETER NOT IN CAL SET** (error #64). Correction is not valid for the selected measurement parameter. Refer to the "Measurement Calibration" section.

**D2/D1 INVALID WITH SINGLE CHANNEL** (error #130). A D2/D1 measurement can only be made if both channels are on.

**D2/D1 INVALID. CH1 CH2 NUM PTS DIFFERENT** (error #152). A D2/D1 measurement can only be made if both channels have the same number of points.

**DEADLOCK** (error #111). A fatal firmware error occurred before instrument preset completed. Refer to the "Troubleshooting" section of the *Service Manual*.

**DEMODULATION NOT VALID** (error #17). Demodulation is only valid for the CW time mode. Refer to the "Time and Frequency Domain Transforms" section.

**DEVICE: not on, not connect, wrong addr**s (error #119). The device at the power meter address cannot be accessed by the analyzer. Verify power to the device, and check the HP-IB connection between the analyzer and the device. Ensure that the device address recognized by the analyzer matches the HP-IB address set on the device itself. Refer to "[LOCAL] Key" in Chapter 10 for instructions on setting peripheral addresses.

**DISK HARDWARE PROBLEM** (error #39). The disk drive is not responding correctly. Refer to the disk drive operating manual.

**DISK IS WRITE PROTECTED** (error #48). The store operation cannot write to a write-protected disk. Slide the write-protect tab over the write-protect opening in order to write data on the disk.

**DISK MEDIUM NOT INITIALIZED** (error #40). The disk must be initialized before it can be used. Refer to "Initialize Menu" in the "Save and Recall" section.

**DISK: not on, not connected, wrong addr**s (error #38). The disk cannot be accessed by the analyzer. Verify power to the disk drive, and check the HP-IB connection between the analyzer and the disk drive. Ensure that the disk drive address recognized by the analyzer matches the HP-IB address set on the disk drive itself. Refer to "[LOCAL] Key" in Chapter 10 for instructions on setting peripheral addresses.

**DISK WEAR – REPLACE DISK SOON** (error #49). Cumulative use of the disk is approaching the maximum. Copy files as necessary using an external controller. If no controller is available, load instrument states from the old disk and store them to a newly initialized disk using the save/recall features of the analyzer. Refer to “Saving Instrument States” in the “Save and Recall” section.

**DUPLICATING TO THIS SEQUENCE NOT ALLOWED** (error #125). A sequence cannot be duplicated to itself.

**EXCEEDED 7 STANDARDS PER CLASS** (error #72). A maximum of seven standards can be defined for any class. Refer to “Modifying Calibration Kits” in the “Measurement Calibration” section.

**FIRST CHARACTER MUST BE A LETTER** (error #42). The first character of a disk file title or an internal save register title must be an alpha character.

**FUNCTION NOT VALID** (error #14). The requested function is incompatible with the current instrument state.

**FUNCTION NOT VALID DURING MOD SEQUENCE** (error #131). Sequencing operations cannot be performed while a sequence is being modified.

**ILLEGAL UNIT OR VOLUME NUMBER** (error #46). The disk unit or volume number set in the analyzer is not valid. Refer to “HP-IB Menu” in Chapter 10, and to the disk drive operating manual.

**INIT DISK removes all data from disk** (information message, not an error). Continuing with the initialize operation will DESTROY any data currently on the disk.

**INITIALIZATION FAILED** (error #47). Disk initialization failed, probably because the disk is damaged.

**INSTRUMENT STATE MEMORY CLEARED** (error #56). The five instrument state registers have been cleared from memory along with any saved calibration data or calibration kit definitions.

**INVALID KEY** (error #2). An undefined softkey was pressed.

**LIST TABLE EMPTY** (error #9). The frequency list is empty. To implement list frequency mode, add segments to the list table. Refer to “Edit List Menu” in Chapter 8.

**LOG SWEEP REQUIRES 2 OCTAVE MINIMUM SPAN** (error #150). A logarithmic sweep is only valid if the stop frequency is greater than 4 times the start frequency. For frequency spans of less than two octaves, the sweep type automatically reverts to linear sweep.

**LOW PASS: FREQ LIMITS CHANGED** (information message, not an error). The frequency domain data points must be harmonically related from DC to the stop frequency. That is,  $stop = n \times start$ , where  $n$  = number of points. If this condition is not true when a low pass mode (step or impulse) is selected and transform is turned on, the analyzer resets the start and stop frequencies. The stop frequency is set close to the entered stop frequency, and the start frequency is set equal to  $stop/n$ . Refer to “Time Domain Low Pass” in the “Time Domain” section.

**LOW PASS MODE NOT ALLOWED** (error #18). Low pass time domain mode is allowed only with 801 points or less.

**MEMORY FOR CURRENT SEQUENCE IS FULL** (error #132). All the memory in the sequence being modified is filled with instrument commands.

**MORE SLIDES NEEDED** (error #71). When a sliding load is used (in a user-defined calibration kit), at least three slide positions are required to complete the calibration.

**NO CALIBRATION CURRENTLY IN PROGRESS** (error #69). The **[RESUME CAL SEQUENCE]** softkey is not valid unless a calibration was already in progress. Start a new calibration. Refer to "Correction Menu" in the "Measurement Calibration" section.

**NO DISK MEDIUM IN DRIVE** (error #41). No disk was found in the current disk unit. Insert a disk, or check the disk unit number stored in the analyzer. Refer to "HP-IB Menu" in Chapter 10 (under "[LOCAL Key]").

**NO FAIL FOUND** (service error #114). The self-diagnose function of the instrument operates on an internal test failure. At this time, no failure has been detected. Refer to "Internal Tests" in the "Service Key Menus" portion of the *Service Manual*.

**NO FILE(S) FOUND ON DISK** (error #45). No files (of the type created by an analyzer store operation) were found on the disk. Or if a specific file title was requested, that file was not found on the disk.

**NO IF FOUND: CHECK R INPUT LEVEL** (error #5). The first IF signal was not detected during pretune. Make sure the RF output is connected externally to the R input, with at least  $-35$  dBm input power to R.

**NO LIMIT LINES DISPLAYED** (error #144). Limit lines are turned on but cannot be displayed on polar or Smith chart display formats.

**NO MARKER DELTA – SPAN NOT SET** (error #15). The **[MARKER → SPAN]** softkey function requires that delta marker mode be turned on, with at least two markers displayed. Refer to the "Using Markers" section.

**NO PHASE LOCK: CHECK R INPUT LEVEL** (error #7). The first IF signal was detected at pretune, but phase lock could not be acquired. Refer to the "Troubleshooting" section of the *Service Manual*.

**NO VALID MEMORY TRACE** (error #54). If a memory trace is to be displayed or otherwise used, a data trace must first be stored to memory. Refer to "Display Menu" in Chapter 7.

**NO VALID STATE IN REGISTER** (error #55). A request to load an instrument state from an internal register was received over HP-IB, and that register is empty.

**NOT ENOUGH SPACE ON DISK FOR STORE** (error #44). The store operation will overflow the available disk space. Insert a new disk or purge the files appearing last in the directory, to create free disk space.

**ONLY LETTERS AND NUMBERS ARE ALLOWED** (error #43). Only alpha-numeric characters are allowed in disk file titles or internal save register titles. Other symbols are not allowed.



**OPTIONAL FUNCTION; NOT INSTALLED** (error #1). The function you requested requires a capability provided by an option to the standard analyzer. That option is not currently installed. (Options are 003, 3 GHz operation, and 010 time domain transform.)

**OVERLOAD ON INPUT, TESTPORT POWER REDUCED** (error #57). When the power level at one of the three receiver inputs exceeds approximately +4 dBm, the RF output power level is automatically reduced to -20 dBm. The annotation P↓ appears in the left margin of the display to indicate that the power trip function has been activated. When this occurs, toggle the **[POWER TRIP]** softkey off and reset the power at a lower level. Refer to "Power Menu" in Chapter 8.

**PHASE LOCK CAL FAILED** (error #4). An internal phase lock calibration routine is automatically executed at power-on and preset any time a loss of phase lock is detected. This message indicates that phase lock calibration was initiated and the first IF detected, but a problem prevented the calibration from completing successfully. Refer to the "Source Troubleshooting" section of the *Service Manual*.

**PHASE LOCK LOST** (error #8). Phase lock was acquired but then lost. Refer to the "Troubleshooting" section, and to "Service Modes Menu" in the *Service Manual*.

**PLOT ABORTED** (error #27). Pressing the **[LOCAL]** key causes the analyzer to abort the plot in progress.

**PLOTTER: not on, not connected, wrong addr**s (error #26). The plotter does not respond to control. Verify power to the plotter, and check the HP-IB connection between the analyzer and the plotter. Ensure that the plotter address recognized by the analyzer matches the HP-IB address set on the plotter itself. Refer to "**[LOCAL]** Key" in Chapter 10 for instructions on setting peripheral addresses.

**PLOTTER NOT READY-PINCH WHEELS UP** (error #28). The plotter pinch wheels clamp the paper in place. When the pinch wheels are raised, the plotter indicates a "not ready" status on the bus.

**POSSIBLE FALSE LOCK** (error #6). Phase lock has been achieved, but the source may be phase locked to the wrong harmonic of the synthesizer. Perform the source pretune correction routine in the "Adjustments" section of the *Service Manual*.

**POW MET INVALID** (error #116). The power meter indicates an out-of-range condition. Check the test setup.

**POW MET NOT SETTLED** (error #118). Sequential power meter readings are not consistent. Verify that the equipment is set up correctly. If so, preset the instrument and restart the routine.

**POW MET: not on, not connected, wrong addr**s (error #117). The power meter cannot be accessed by the analyzer. Verify that the power meter address and model number set in the analyzer match the address and model number of the actual power meter. Refer to "**[LOCAL]** Key" in Chapter 10 for more information.

**POWER SUPPLY HOT!** (error #21). The temperature sensors on the A8 post-regulator assembly have detected an overtemperature condition. The power supplies regulated on the post-regulator have been shut down.

**POWER SUPPLY SHUT DOWN!** (error #22). One or more supplies on the A8 post-regulator assembly have been shut down due to an overcurrent, overvoltage, or undervoltage condition.

**PRINT ABORTED** (error #25). Pressing the **[LOCAL]** key causes the analyzer to abort output to the printer.

**PRINTER: not on, not connected, wrong addr** (error #24). The printer does not respond to control. Verify power to the printer, and check the HP-IB connection between the analyzer and the printer. Ensure that the printer address recognized by the analyzer matches the HP-IB address set on the printer itself. Refer to “[LOCAL] Key” in Chapter 10 for instructions on setting peripheral addresses.

**PRINT/PLOT IN PROGRESS, ABORT WITH LOCAL** (information message, not an error). If a print or plot is in progress and a second print or plot is attempted, this message is displayed and the second attempt is ignored. To abort a print or plot in progress, press **[LOCAL]**.

**PROBE POWER SHUT DOWN!** (error #23). The analyzer biasing supplies to the HP 85024A external probe are shut down due to excessive current. Troubleshoot the probe, and refer to the “Power Supply” troubleshooting section in the *Service Manual*.

**REQUESTED DATA NOT CURRENTLY AVAILABLE** (error #30). The analyzer does not currently contain the data being requested. For example, this condition occurs when error term arrays are requested and no calibration is active.

**SELECTED SEQUENCE IS EMPTY** (error #124). The sequence you tried to run does not contain instrument commands.

**SELF TEST #n FAILED** (service error #112). Internal test #n has failed. Several internal test routines are executed at instrument preset. The analyzer reports the first failure detected. Refer to the “Troubleshooting” section of the *Service Manual* for more information on internal tests and the self-diagnose feature.

**SEQUENCE ABORTED** (error #157). The running sequence was stopped prematurely when the operator pressed the **[LOCAL]** key.

**SEQUENCE MAY HAVE CHANGED, CAN'T CONTINUE** (error #153). The sequence that was paused cannot be continued because it has been modified. The sequence must be started again.

**SOURCE PARAMETERS CHANGED** (error #61). Some of the stimulus parameters of the instrument state have been changed, due to a request to turn correction on. A calibration set for the current measurement parameter was found and activated. The instrument state was updated to match the stimulus parameters of the calibration state.

**SOURCE POWER TRIPPED, RESET UNDER POWER MENU** (information message, not an error). The power level at one of the inputs has exceeded the maximum allowed, and power has been automatically reduced. The annotation P↓ indicates that power trip has been activated. Press **[MENU] [POWER] [POWER TRIP ON]** to turn off the power trip, then reset the power at a lower level. This message follows error #57, OVERLOAD ON INPUT TEST PORT, POWER REDUCED.

**SWEEP TIME INCREASED** (error #11). Sweep time is automatically increased to compensate for other instrument state changes. Some parameter changes that cause an increase in sweep time are narrower IF bandwidth, an increase in the number of points, and a change in sweep type.

**SWEEP TIME TOO FAST** (error #12). The fractional-N and digital IF circuits have lost synchronization. Refer to the "Troubleshooting" section of the *Service Manual*.

**SWEEP TRIGGER SET TO HOLD** (information message, not an error). The instrument is in a hold state and is no longer sweeping.

**SYNTAX ERROR** (error #33). An improperly formatted command was received over HP-IB. Refer to the "HP-IB Quick Reference Guide" for proper command syntax.

**SYST CTRL OR PASS CTRL IN LOCAL MENU** (error #36). The analyzer cannot control a peripheral device on the bus while it is in talker/listener mode. Use the local menu to change to system controller or pass control mode. Refer to "[LOCAL] Key" in Chapter 10 for information on HP-IB controller modes.

**SYSTEM IS NOT IN REMOTE** (error #52). The analyzer is in local mode. In this mode, the analyzer will not respond to HP-IB commands with front panel key equivalents. It will, however, respond to commands that have no such equivalents, such as status requests.

**TEST ABORTED** (error #113). A service test has been prematurely stopped at the operator's request.

**TOO MANY SEGMENTS OR POINTS** (error #50). Frequency list mode is limited to 30 segments or 1632 points. Refer to "Edit List Menu" in Chapter 8 for more information.

**TRANSFORM, GATE NOT ALLOWED** (error #16). Transformation to the time domain is only possible in linear and CW sweep types.

**TROUBLE! CHECK SETUP AND START OVER** (service error #115). The equipment setup for the adjustment procedure in progress is not correct. Check the setup diagram and instructions in the "Adjustments and Correction Constants" section of the *Service Manual*. Start the procedure again.

**WAITING FOR CLEAN SWEEP** (information message, not an error). The instrument has not completed a new sweep since the last change in instrument settings. The displayed data is questionable until this message goes away. In single sweep mode, the instrument ensures that all changes to the instrument state, if any, have been implemented before taking the sweep.

**WAITING FOR DISK** (information message, not an error). This message is displayed between the start and finish of a read or write operation to a disk.

**WAITING FOR HP-IB CONTROL** (information message, not an error). The analyzer has been instructed to use pass control (USEPASC). When the instrument next receives an instruction requiring active controller mode, it requests control of the bus and simultaneously displays this message. If the message remains, the system controller is not relinquishing the bus.

**WRITE ATTEMPTED WITHOUT SELECTING INPUT TYPE** (error #32). The data header "#A" for the analyzer was received with no preceding input command (such as INPUDATA). The instrument recognized the header but did not know what type of data to receive. Refer to the "HP-IB Quick Reference Guide" for command syntax information.

**WRONG DISK FORMAT, INITIALIZE DISK** (error #77). A command to store, load, or read file titles has been received, but the disk format does not conform to the Logical Interchange Format (LIF). The instrument must initialize the disk before reading or writing to it. Refer to "Initialize Menu" in the "Save and Recall" section.

## ERROR MESSAGES IN NUMERICAL ORDER

Refer to the alphabetical listing for explanations and suggestions for solving the problems.

1. OPTIONAL FUNCTION; NOT INSTALLED
2. INVALID KEY
3. CORRECTION CONSTANTS NOT STORED
4. PHASE LOCK CAL FAILED
5. NO IF FOUND: CHECK R INPUT LEVEL
6. POSSIBLE FALSE LOCK
7. NO PHASE LOCK: CHECK R INPUT LEVEL
8. PHASE LOCK LOST
9. LIST TABLE EMPTY
11. SWEEP TIME INCREASED
12. SWEEP TIME TOO FAST
13. AVERAGING INVALID ON NON-RATIO MEASURE
14. FUNCTION NOT VALID
15. NO MARKER DELTA — SPAN NOT SET
16. TRANSFORM, GATE NOT ALLOWED
17. DEMODULATION NOT VALID
18. LOW PASS MODE NOT ALLOWED
21. POWER SUPPLY HOT!
22. POWER SUPPLY SHUT DOWN!
23. PROBE POWER SHUT DOWN!
24. PRINTER: not on, not connect, wrong addr
25. PRINT ABORTED
26. PLOTTER: not on, not connect, wrong addr
27. PLOT ABORTED
28. PLOTTER NOT READY-PINCH WHEELS UP
30. REQUESTED DATA NOT CURRENTLY AVAILABLE
31. ADDRESSED TO TALK WITH NOTHING TO SAY
32. WRITE ATTEMPTED WITHOUT SELECTING INPUT TYPE
33. SYNTAX ERROR
34. BLOCK INPUT ERROR
35. BLOCK INPUT LENGTH ERROR
36. SYST CTRL OR PASS CTRL IN LOCAL MENU
37. CAN'T CHANGE-ANOTHER CONTROLLER ON BUS
38. DISK: not on, not connected, wrong addr
39. DISK HARDWARE PROBLEM
40. DISK MEDIUM NOT INITIALIZED
41. NO DISK MEDIUM IN DRIVE
42. FIRST CHARACTER MUST BE A LETTER
43. ONLY LETTERS AND NUMBERS ARE ALLOWED
44. NOT ENOUGH SPACE ON DISK FOR STORE
45. NO FILE(S) FOUND ON DISK
46. ILLEGAL UNIT OR VOLUME NUMBER
47. INITIALIZATION FAILED
48. DISK IS WRITE PROTECTED
49. DISK WEAR-REPLACE DISK SOON
50. TOO MANY SEGMENTS OR POINTS
52. SYSTEM IS NOT IN REMOTE
54. NO VALID MEMORY TRACE
55. NO VALID STATE IN REGISTER
56. INSTRUMENT STATE MEMORY CLEARED
57. OVERLOAD ON INPUT, TEST PORT POWER REDUCED
61. SOURCE PARAMETERS CHANGED
63. CALIBRATION REQUIRED
64. CURRENT PARAMETER NOT IN CAL SET
66. CORRECTION TURNED OFF
68. ADDITIONAL STANDARDS NEEDED
69. NO CALIBRATION CURRENTLY IN PROGRESS
71. MORE SLIDES NEEDED
72. EXCEEDED 7 STANDARDS PER CLASS
74. CALIBRATION ABORTED
77. WRONG DISK FORMAT, INITIALIZE DISK
111. DEADLOCK.
112. SELF TEST #n FAILED
113. TEST ABORTED
114. NO FAIL FOUND
115. TROUBLE! CHECK SETUP AND START OVER
116. POW MET INVALID
117. POW MET: not on, not connected, wrong addr
118. POW MET NOT SETTLED
119. DEVICE: not on, not connect, wrong addr
124. SELECTED SEQUENCE IS EMPTY
125. DUPLICATING TO THIS SEQUENCE NOT ALLOWED
127. CAN'T STORE/LOAD SEQUENCE, INSUFFICIENT MEMORY
130. D2/D1 INVALID WITH SINGLE CHANNEL
131. FUNCTION NOT VALID DURING MOD SEQUENCE
132. MEMORY FOR CURRENT SEQUENCE IS FULL
144. NO LIMIT LINES DISPLAYED
150. LOG SWEEP REQUIRES 2 OCTAVE MINIMUM SPAN
152. D2/D1 INVALID. CH1 CH2 NUM PTS DIFFERENT
153. SEQUENCE MAY HAVE CHANGED, CAN'T CONTINUE
157. SEQUENCE ABORTED
159. CH1 (CH2) TARGET VALUE NOT FOUND

# HP 8752A/B Operating Manual

## INDEX

- [ ] Brackets .....(see User's Guide)
  - [ ] Brackets .....(see User's Guide)
  - Δ Active Marker ..... 7-77
  - Δ Delta Marker ..... 7-78
  - ↑ Fast Sweep Indicator ..... 5-7, 8-3
  - [▲] and [▼] Keys ..... 9-2
  - [x1] Key ..... 9-2
  - π Non-Printable Characters ..... 10-7
  - \* Notation ..... 5-7, 8-7
  - \* in Table of Measured Values ..... 10-75
  - Δ REF = Δ ..... 7-79
  - 1/S Inverse Data Values ..... 7-6
  - 3.5 mm Typical Performance ..... 2-9 – 2-11
  - 50 ohm Type-N Typical Performance ..... 2-9 – 2-11
- A**
- Aborting a Print or Plot ..... 10-74
  - AC Line Voltage ..... 2-6
  - AC Power Cables ..... 1-10
  - Accessories Available ..... 1-4 – 1-7
  - Accuracy Enhancement ..... 7-34
  - Active Channel ..... 5-6,5-7,6-1
  - Active Entry Area ..... 5-6
  - Active Function ..... 5-1
  - Active Marker ..... 7-77
  - Adapter Kits ..... 1-6
  - Adapters ..... 1-6, 7-34, 7-35
  - Address Menu ..... 10-7
  - Addresses, Setting ..... 10-7,(see also User's Guide)
  - Adjust Display Menu ..... 7-20
  - Admittance Measurements ..... 7-5
  - ALC ..... 4-2
  - Aliasing ..... 10-61
  - Alternate Sweep ..... 7-48, (see also User's Guide)
  - Anti-Static Mat (see User's Guide)
  - Aperture, Group Delay ..... 7-12
  - Arbitrary Frequency List ..... 8-10
  - Arbitrary Impedance ..... 7-57
  - [AUTO SCALE] Softkey ..... 7-14
  - Autostarting Sequences ..... 10-35
  - Auto Sweep Time ..... 8-3
  - AUX INPUT Connector ..... 5-8, 5-9
  - Auxiliary Input Softkey ..... 7-4
  - Auxiliary Input Voltage ..... 2-6
  - Auxiliary Marker Value ..... 7-80
  - Average Menu ..... 7-28
  - Averaging ..... 7-25, (see User's Guide)
  - Averaging Factor ..... 7-28
  - [AVERAGING RESTART] Softkey ..... 7-28
  - [AVG] Key ..... 7-25
  - "Avg" Notation ..... 5-7
- B**
- Background Intensity ..... 7-20
  - [BACK SPACE] Key ..... 9-2
  - Band-Limited Standards ..... 7-58
  - Bandpass Mode ..... 10-47, 10-49
  - Bandwidth, 3 dB ..... (see User's Guide)
  - Bandwidth, IF ..... 7-29
  - Bandwidth Search ..... 7-86
  - Basic Measurement Sequence ..... (see User's Guide)
  - Beepers ..... 7-19
  - [BEEP FAIL] Softkey ..... 10-16
  - Binary Format ..... 10-96,10-98,10-99
  - Block Diagram, Simplified ..... 4-1
  - Brackets ..... (see User's Guide)
  - [BRIGHTNESS] Softkey ..... 7-22
  - Bus Mode ..... 3-6
  - Bus Structure ..... 3-3
- C**
- C? ..... 5-7
  - Cabinet Dimensions ..... 2-7
  - Cable Faults ..... 10-56
  - Cables, Compatible ..... 1-2
  - Cable Stability ..... 2-11
  - [CAL] Key ..... 7-43
  - Cal Kit Menu ..... 7-46
  - Cal Kit Models ..... 7-52
  - Cal Kits, Selecting Defaults ..... 7-46
  - Calibration ..... 7-34
    - 1-Port Reflection ..... 7-35, 7-51
    - Frequency Response ..... 7-35, 7-51
    - Response and Isolation ..... 7-35, 7-51
  - Calibration Agreement ..... 1-5
  - Calibration Data, Saving ..... 7-44
  - Calibration, Invalid ..... 7-43
  - Calibration Kits ..... 1-5, 7-43
  - Calibration Menu ..... 7-50
  - Calibration Procedures Compared ..... 7-51, (see also User's Guide)
  - Calibration Procedures, Definitions ..... 7-51
  - Calibration Procedures, Step-by-Step ..... (see User's Guide)
  - Calibration Sets, Saving ..... 10-86
  - Calibration Standard Frequency Response ..... 7-40 – 7-42
  - Calibration Temperature ..... 10-89
  - Calibration Tutorial ..... (see User's Guide)
  - Capacitance Model ..... 7-57
  - Capacitance, Fringing ..... 7-40, 7-57
  - Capacitive Reactance ..... 7-8
  - [CENTER] and [SPAN] Keys ..... 8-2
  - [CH 1] and [CH 2] Keys ..... 6-1
  - Changing a Sequence Title ..... 10-33, (see also User's Guide)
  - Changing Channels During Calibration ..... 7-44
  - Channel, Active ..... 5-6,5-7,6-1
  - Channel Coupling ..... 8-5
  - Characteristic Impedance ..... 7-48
  - Chop Sweep Mode ..... 7-49, (see also User's Guide)
  - Class, Number of Standards in ..... 5-60
  - Clear Register Menu ..... 10-90
  - Clearance for Air Circulation (see User's Guide)
  - Clearing a Sequence from Memory ..... (see User's Guide)
  - Color Adjust Menu ..... 7-22
  - Color
    - Adjusting ..... 7-19
    - Default ..... 7-20
    - Modifying ..... 7-20
    - Recalling ..... 7-20
    - Saving ..... 7-20
    - Color Softkey ..... 7-22
  - Compatible Calibration Kits ..... 1-5,7-43,7-46
  - Compression Measurements ..... (see User's Guide)
  - Computer Controllers ..... 1-3
  - Connection Techniques ..... 7-43
  - Connector Characteristics ..... 2-6, 5-5, 5-9
  - Connector Pin Recession ..... 2-6
  - Connector Repeatability ..... 2-11
  - Connectors, Rear Panel ..... 5-9
  - Continuous Sweep ..... 8-7
  - Control Lines ..... 3-3
  - Controller, Computer ..... 1-3
  - Controller Modes ..... 10-5
  - Conversion Menu ..... 7-5
  - [COPY FROM REG TITLES] Softkey ..... 10-101
  - [COPY FROM FILE TITLE] Softkey ..... 10-92
  - [COPY] Key ..... 10-73
  - "Cor" Notation ..... 5-7, 7-45
  - Correctable Errors ..... 7-51
  - Correction Menu ..... 7-45
  - Coupled Channels ..... 8-5
  - Coupled Markers ..... 7-81
  - Coupling, Stimulus ..... 8-5
  - Crosstalk Error ..... 7-38,7-71
  - Crosstalk, System ..... 2-11
  - Cutoff Frequency of Standards ..... 7-59
  - CW Frequency ..... 8-5
  - CW Time ..... 8-9
- D**
- Damaged Shipment ..... (see User's Guide)
  - Data Bus ..... 3-3
  - Data Entry ..... 9-1
  - [DATA / MEM] Softkey ..... 7-18
  - [DATA – MEM] Softkey ..... 7-18
  - [DATA → MEMORY] Softkey ..... 7-18
  - [DATA and MEMORY] Softkey ..... 7-18
  - Data Transfer, HP-IB ..... 2-4
  - Debug Mode ..... 10-7
  - Decision Making Example Sequences ..... 10-41
  - Decision Making Menu, Sequencing ..... 10-37
  - Default Addresses ..... 10-7,(see also User's Guide)
  - Default Cal Kits ..... 7-46
  - [DEFAULT COLORS] Softkey ..... 7-20
  - Default Conditions ..... 10-109
  - Default Plot Parameters ..... 10-76
  - [DEFAULT PLOT SETUP] Softkey ..... 10-76
  - Define Standard Menus ..... 7-55
  - Define Store Menu ..... 10-94
  - Defining a Cal Kit, Example Procedure ..... 7-63
  - "Del Notation" ..... 5-7
  - Delay, Electrical ..... 7-15,(see also User's Guide)
  - Delay Format ..... 7-8,(see also User's Guide)



Line Stretchers	7-15
Line Voltage	2-6
Line Voltage Selector Switch	5-8, 5-9
Linear Frequency	8-8, 8-9
Linear Magnitude Format	7-10
Linear Phase, Deviation from	7-15
<b>[LIST FREQ]</b> Softkey	8-8
<b>[LIST VALUES]</b> Softkey	10-75
List Frequency	3-12
List Frequency, Using	8-10
Listing Measured Data	10-75
Load Cutoff Frequencies	7-59
Load Match Error	7-37
Load Match	2-11
Load Sequence from Disk Menu	10-31
<b>[LOCAL]</b> Key	10-4
Local Lockout	10-4
Locating a File on Disk	10-102
<b>[LOG FREQ]</b> Softkey	8-8
Log Magnitude Format	7-7
Loss Offset	7-58
Low Pass Frequency, Setting	10-50,10-52
Low Pass Mode	10-52

## M

<b>[M/μ]</b> Key	9-1, 9-2
Magnitude Characteristics	2-2
"man" Notation	5-7
Manual Sweep Time	8-3
Marker Bandwidth Search	7-85
<b>[MARKER → CW]</b> Softkey	7-85,10-37
<b>[MARKER → DELAY]</b> Softkey	7-15,7-85
Marker Function Menu	7-84
Marker Menu	7-77
<b>[MARKER → REFERENCE]</b> Softkey	7-15,7-85
Marker Search	7-86,7-88, (see also User's Guide)
<b>[MARKER →]</b> Softkeys	7-85
Marker Statistics	7-27, 7-84
Marker Stats, Bandwidth	5-8
Marker Tracking	7-87
Marker Values	5-8
Markers	7-75,(see also User's Guide)
Masking	10-58
Math Capabilities	7-18
<b>[MEAS]</b> Key	7-2
<b>[MEASURE RESTART]</b> Softkey	8-5
Measured Inputs	5-7
Measurement Calibration	7-34
Measurement Port Characteristics	2-11
Measurement Ports	5-4
Measurement Throughput	2-4
Measurement Type Menu	7-4
Measurement Uncertainty	7-34
Measurement Uncertainty Specifications	2-11
Memory Math	7-16 to 7-18
Memory Trace	7-16
<b>[MENU]</b> Key	8-2
Menus	5-1
Message Area	5-6
Message Transfer	3-3
Mismatch Errors	7-37
<b>[MKR]</b> Key	7-75
<b>[MKR FCTN]</b> Key	7-84
Modifying Cal Kit Procedure	7-63
Modifying Calibration Kits	7-52
Modify Colors Menu	7-21

## N

Network Analyzer Description	1-2
New Sequence/Modify Sequence Menu	10-29
Noise Floor, System	2-11
Noise Reduction Techniques	7-25 - 7-30, (see also User's Guide)
Non-Volatile Memory	10-87
Number of Groups	8-7
Number of Points	8-4
Numeric Keypad	9-1, 9-2

## O

Offset Delay	7-58
Offset Impedance	7-59
Offset Limits Menu	10-22
Offset Loss	7-58
Offset Short Measured as Arc	7-40
Offset Z0	7-59
Offsets, Definitions	7-58
Open Calibration Standard Capacitance	7-40,7-57
Open Calibration Standard, Why Measured Performance is Curved	7-40
Operating Parameters Listing	10-75
Operator's Check	(see Performance Tests in <i>Service Manual</i> )
Option 010, Time Domain Transform	10-47, (see also User's Guide)
Option 908 Flange Kit	1-4, (see also User's Guide)
Option 913 Flange Kit	1-4
Options Available	1-4
Oscilloscope-Like Mode	8-9
Out-of-Band Rejection	(see User's Guide)
Out-of-Limits Indications	10-11
Output Power	8-6
Output Power Specifications	2-1
Overlay Display	7-17

## P

"P " Notation	5-7
"P?" Notation	5-7
Packaging	1-9
Parameter Conversions	7-5,7-6
Passband Ripple Measurement	(see User's Guide)
Pass Control	10-5
Pass/Fail Testing	10-11
Pen Numbers	10-79
Performance with User-Modified Cal Kits	7-62
Permittivity, Relative	7-15
Phase Characteristics	2-2
Phase Distortion	(see User's Guide)
Phase Format	7-7
Phase Offset	7-15
Phase Response Measurement	(see User's Guide)
Phase Shift Linearity	7-11
Plot Scale	10-78
Plot Speed	10-79
Plotters, Compatible	1-7
Plotting	10-75,(see also User's Guide)
Plotting Parameters, Default	10-76
Plotting on Preprinted Forms	10-78
Plotting on Transparencies	10-78
Plotting Tutorial	(see User's Guide)
Plugs, Power	1-11

<b>[P MTR/HPIB TO TITLE]</b> Softkey	10-39
Point Definition	8-4
Polar Format	7-9,(see also User's Guide)
Polar Marker Menu	7-82
Polar Markers	(see User's Guide)
Port Extensions	7-47,7-48
Power Cables	1-11
Power Considerations	1-8
Power Cord Receptacle	5-9
Power Level	8-3, 8-6
Power Specifications	2-1
Power Requirements	(see User's Guide)
Power-On Condition	10-109
Predefined Cal Kit Models	7-46
Preset State	10-109
Printers, Compatible	1-7
Printing	10-73,(see also User's Guide)
Printing Tutorial	(see User's Guide)
Print/Plot Controller Modes	10-73
Print/Plot Setups Menu	10-76
Probe Power	5-5
Purge File Menu	10-97

## R

<b>[R + jX MKR]</b> Softkey	7-83
Rack Assembly	(see User's Guide)
Rack-Mount Flange Kits	1-4
Rack-Mounted Systems	(see User's Guide)
Rack Storage	(see User's Guide)
Rack, System	1-6
Range, Alias Free	10-62
Range Resolution	10-62
Raw Data Arrays	4-4
<b>[Re/Im MKR]</b> Softkey	7-83
Reactance Values	7-8
<b>[READ FILE TITLES]</b> Softkey	10-97,10-103
Reading Sequences Using HP-IB	10-41
Real Format	7-11
Rear Panel Connector Characteristics	2-6, 5-9
Rear Panel Features	5-9
<b>[RECALL COLORS]</b> Softkey	7-20
<b>[RECALL]</b> Key	10-101
Recall Menu	10-101
Receiving Shipment	(see User's Guide)
Reference Level	5-8
Reference Marker	7-79
Reference Plane, Test Port	7-48,7-49
Reference Position	7-15
Reference Value	7-15
Reflection 1-Port Calibration	7-39,7-51, (see also User's Guide)
Reflection Error Model	7-65
Reflection Measurements	(see User's Guide)
Reflection Softkey	7-4
Reflection Uncertainty Equations	2-19
Register Titles	10-91
Relative Permittivity	7-15
Relative Velocity	7-15,7-48,10-51
Remote Operation	13-1
Remote Programming Modes	10-5,10-6
Repeatability, Connector	2-11
<b>[RESET COLOR]</b> Softkey	7-22
Resistance Values	7-8
Response Cal Procedures	(see User's Guide)
Response Calibration Defined	7-39
Response Resolution	10-62
Response Value, Scale	7-14
Response and Isolation Calibration	7-39,7-51,(see also User's Guide)
<b>[RESUME CAL SEQUENCE]</b> Softkey	7-45
RGB Connectors	5-9
Ripple Measurements	(see User's Guide)



**S**

[SAVE COLORS] Softkey	7-20
[SAVE USER KIT] Softkey	7-47
[SAVE] Key	10-89
Saving Calibration Data	7-44,10-86
Saving Instrument States	10-85
Scale/Div	5-8
[SCALE/DIV] Softkey	7-14
[SCALE REF] Key	7-14
Segment Menu, Frequency List	8-11
Sequence More Menu	10-33
Sequencing	10-24 to 10-43, (see also User's Guide)
Autostarting Sequences	10-35
Decision Making Menu	10-37
Decision Making Example Sequences	10-41
Entering Sequences Using HP-IB	10-41
HP-GL Considerations	10-40
Load Sequence from Disk Menu	10-31
New Sequence/Modify Sequence Menu	10-29
Purge Sequence from Disk Menu	10-32
Reading Sequences Using HP-IB	10-41
Sequence More Menu	10-33
Special Functions	10-34
Special Function Menu	10-36
Special Function More Menu	10-38
Store Sequence to Disk Menu	10-30
What is Sequencing?	10-25
Serial Numbers	1-9
[SET FREQ LOW PASS] Softkey	7-50,10-52
[SET Z0] Softkey	7-48
Setting Addresses	10-7
Setting Up the System	(see User's Guide)
Shipment	(see User's Guide)
Short Calibration: Standard, Why Measured	
Performance as Curved	7-40
Sidelobes	10-59
Simultaneous Measurements	(see User's Guide)
Single Frequency List Segment Selection	8-11
Single Sweep	8-7
Skin Effect	7-58
Smith Chart Format	7-8,(see also User's Guide)
Smith Marker Menu	7-83
"Smo" Notation	5-7
Smoothing	7-26
Smoothing Aperture	7-26
Softkey Menus	5-1
Softkeys, Representation of	(see User's Guide)
Source	4-2
Source Characteristics	2-1
Source Match Error	7-37,7-67
Sources of Measurement Errors	7-36
[SPAN] Key	8-2
Special Functions, Sequencing	10-34
Specifications, Instrument	2-1
Specifications, System	2-8
Specify Class Menus	7-60,7-61
Specify Offset Menu	7-58
Split Display	7-17
Stability, Cable	10-47
Standard Class Assignments Table	7-60
Standard Class Definition	7-53
Standard Coefficient Definition	7-53

Standard Definition	7-53
Standard Definitions Table	7-55
Standard Devices	7-40,7-43
Standard Frequencies	7-58
Standard Type Definition	7-53
Standards, Compatible	1-5
Standards, Defining for User Kit	7-55
Standing Wave Ratio	7-10
Start and Stop Frequency Values	8-2
[START] and [STOP] Keys	8-2
Statistics	7-84
[STATS on/OFF] Softkey	7-85
Status Notations	5-7
Step Keys	9-1/9-2
Step and Impulse Modes	10-47
Stimulus Coupling	8-5
Stimulus Function Block Keys	8-1
Stimulus Function	8-3
Stimulus Start/Stop Values	8-2
Stimulus State for Calibration	7-44
Storage	2-7
Store File Menu	10-93
Stored Calibration Data	10-89
Storing Calibration to External Disk	7-44
Sweep Definition	4-3
Sweep Hold	8-7
Sweep Rate	8-9
Sweep Speed Indicator ↑	5-7, 8-3
Sweep Time	8-5
Sweep Time, Decreasing	(see User's Guide)
Sweep-to-Sweep Averaging	7-25
Sweep Trigger	8-7
Sweep Type	8-8
SWR Format	7-10
System Characteristic Impedance	7-48
System Controller	10-5,10-6
System Error Model	2-12
[SYSTEM] Key	10-2
System Performance	2-8
System Rack	1-6
Systematic Errors	7-36
<b>T</b>	
Talker/Listener	10-5,10-6
Target Menu	7-88
TDR	10-47
Temperature, Change of Data with	10-89
Temperature Drift	2-12
Temperature Ranges, Allowable	2-7
Terminal Impedance of Short and Load	7-57
Terminator Keys	9-1, 9-2
Test Port Characteristics	2-11
Test Port Overload	8-6
Test Port Reference Plane	7-49
Test Sequencing Tutorial	(see User's Guide)
Time Domain	10-47
Bandpass Mode	10-49
Demodulation	10-68
Forward Transform	10-47,10-67
Gate Shape Characteristics	10-66
Gating	10-65
Low Pass	10-52
Low Pass Impulse	10-47
Low Pass Step	10-47,10-56
Masking	10-58
Range	10-61

Reflection Formats, Time Domain	10-48
Reflectometry	10-47
Resolution	10-62
Transform Menus	10-45
Tutorial	(see User's Guide)
Windowing	10-59

Time/Frequency Transforms	10-47
[TINT] Softkey	7-22
Title	5-7
Title Menu	7-24
Title Register Menu	10-91
Trace Math	7-18
Trace Memory	7-18
Tracking Error	7-39,7-67,7-71
Tracking, Marker	7-88
Tracking Specifications	2-11
Transit Time	7-12
Transmission Error Model	7-70
Transmission Measurements	7-4, (see also User's Guide)
Transmissn Softkey	7-4
Transmission Uncertainty Equations	2-20
Trigger Menu	8-7
Type-N Calibration Kit	1-5

**U**

Uncertainty Equations	2-19,2-20
Uncertainty Worksheets	2-14,2-15
Uncorrected Performance	2-11
Units Terminator Keys	9-1, 9-2
Units and Terminators, HP-IB	3-8
Unused Standards, Elimination of	7-52
User Cal Kit	7-52
User-Modified Cal Kits	7-52
Example Procedure	7-63
Performance with	7-62
Verifying	7-62

**V**

Valid Characters	3-7
Vector Accuracy Enhancement	7-34
Velocity Factor	7-15,7-48,10-51
Verification Kit	1-6
Video Output Connectors	5-9
Volatile Memory	10-87
Voltage Input	7-4
Voltage Nodes, Internal	7-4
Volume Number	10-7

**W**

Warning Beeper	7-19
Waveguide Connectors	7-52
Waveguide Standards	7-59
[WIDTHS on OFF] Softkey	7-86
Windowing	10-59
Worksheets, Uncertainty	2-14,2-15

**Y**

Y-Parameter Conversion	7-5,7-6
------------------------	---------

**Z**

Z-Parameter Conversion	7-5,7-6
Z0	7-48
Z0 Offset	7-59

230 CALL IOOUTPUTS(VNA&, A\$, LEN(A\$)): GOSUB ERRORTRAP	Send the command string A\$ out to the analyzer and perform error trapping.
240 RETURN	Return from the IOOUTS routine.

### Running the program

1. The computer reads in the trace data requested by OUTPFORM in *form 5*. The first number for each point is the magnitude in dB.
2. The computer displays the first and last magnitude values read in.

Now go to the analyzer and press [MENU] [NUMBER OF POINTS] [4] [0] [1] [x1]. Run the program again. Note that although the program does not generate an error, only half of the data was read in since the computer only expected the data for 201 points. In this case the analyzer is still waiting to transfer data.

Now change the number of points to 101. Run the program again. Note that a QuickBASIC error was generated since the analyzer ran out of data to transmit before the computer received the data from 201 points that it was expecting.

It is imperative that the receiving array be correctly dimensioned. Fortunately, this is easy to ensure because not only is the number of points in the analyzer's trace readily available through PDIN?, but the size of the transfer block is also easily determined from the header. In addition, QuickBASIC allows dimension statements anywhere in a program, so it is possible to wait until the size of the transfer is known to dimension the receiving array.

The above example program can be modified to take advantage of this by making the following changes:

- Change line 90 to the following:
 

90 DIM HEADER%(0 TO 1)	Prepare an array to receive the two-integer header.
------------------------	---
- Delete line 110.
- Insert the following lines between lines 100 and 120:
 

102 MAX% = 4	The maximum number of bytes to be read in is only the four byte header.
105 ACTUAL% = 0	Initialize the actual number of bytes read in. This variable is given a value by IOENTERB.
108 FLAG% = 1	No swapping of bytes is desired.
110 CALL IOENTERB(VNA&, SEG HEADER%(0), MAX%, ACTUAL%, FLAG%): GOSUB ERRORTRAP	Read in the header as two integers. The second integer is the number of bytes of the trace data that would follow if MAX% were not set to read in only the header.
112 DIM DAT!(1 TO 2, 0 TO HEADER%(1) / 8)	Prepare an array to receive the data. The necessary size of the array can be determined from the known number of bytes of the trace data. (There are HEADER%(1) bytes with four bytes per real number and two real numbers per point.)
115 A\$ = "OUTPFORM;": GOSUB IOOUTS	Tell the analyzer to send out data formatted data in <i>form 5</i> , PC-DOS 32-bit floating point.
118 MAX% = HEADER%(1) + 4	The maximum number of bytes to be read in is the number of bytes following the header, given by HEADER%(1), plus the four bytes in the header.

This modified program is stored on the Example Programs disk as **IPG3BX.BAS**.

Two transfers are done using OUTPFORM. The first transfer reads in only the four-byte header (as two integers) before it terminates. The second of these integers is the size in bytes of the block of data to follow, and with this the receiving array can be correctly dimensioned regardless of the number of points in the trace.

### Example 3C: Data transfer using form 1, network analyzer internal format

The following program illustrates how to transfer data using *form 1*. *Form 1* transfers a six-byte binary string of data for each trace point. The six bytes can be represented as three integers, and *form 1* uses a four-byte header, which can be read in as two integers, so the receiving array DAT! is set up to accommodate this. One transfer is done using OUTPDATA to determine the size of the data block. The receiving array is then correctly dimensioned, and a second transfer is done using OUTPDATA to receive all of the trace data. If there is a 201-point trace, with six-bytes per point plus a four-byte header, this transfer takes only 1210 (201\*6 + 4) bytes. This is considerably faster than the same transfer in either *form 4* or *form 5*.

However, the data received in *form 1* is difficult to decode. Real/imaginary data uses the first two bytes for the imaginary fraction mantissa, the middle two bytes for the real fraction mantissa, the fifth byte for additional resolution when transferring raw data, and the last byte as the common power of two. The data could be recombined and displayed on the computer, but since this requires reformatting time, *form 1* is most useful for getting data to store on disk, as shown in the following program.

This example program is stored on the Example Programs disk as IPG3C.BAS.

10	REM \$INCLUDE: 'QBSETUP'	Call the QuickBASIC initialization file QBSETUP.
20	CLS	Clear the computer CRT.
30	ISC& = 7	Assign the interface select code to a variable.
40	VNA& = 716	Assign the analyzer's address to a variable.
50	CALL IOTIMEOUT(ISC&, 10!): GOSUB ERRORTRAP	Define a system time-out of ten seconds and perform error trapping.
60	CALL IOABORT(ISC&): GOSUB ERRORTRAP	Abort any HP-IB transfers and perform error trapping.
70	CALL IOCLEAR(ISC&): GOSUB ERRORTRAP	Clear the analyzer's HP-IB interface and perform error trapping.
80	CALL IOEDI(ISC&, 0): GOSUB ERRORTRAP	Disable the End-Or-Identify mode for transferring data and perform error trapping.
90	DIM HEADER%(0 TO 1)	Prepare an array to receive the four-byte header as two integers.
100	A\$ = "SING; FORM1; OUTPDATA;": GOSUB IOOUTS	Sweep once and then hold. Tell the analyzer to send out corrected data in <i>form 1</i> , instrument internal binary.
110	MAX% = 4	The maximum number of bytes to be read in is only the four-byte header.
120	ACTUAL% = 0	Initialize the actual number of bytes read in. This variable is given a value by IOENTERB.
130	FLAG% = 4	Reverse every four bytes.
140	CALL IOENTERB(VNA&, SEG HEADER%(0), MAX%, ACTUAL%, FLAG%): GOSUB ERRORTRAP	Read in the header as two integers. The first integer is the number of bytes of the trace data that would follow if MAX% were not set to read in only the header.
150	DIM DAT%(1 TO 3, 0 TO HEADER%(0) / 6)	Prepare an array to receive the data. The necessary size of the array can be determined from the known number of bytes of the trace data. (In addition to one four-byte header, there are six bytes per point in <i>form 1</i> , so allocate three integers per point.)
160	A\$ = "OUTPDATA;": GOSUB IOOUTS	Tell the analyzer to send out corrected data in <i>form 1</i> , instrument internal binary.

170 MAX% = HEADER%(0) + 4	The maximum number of bytes to be read in is the number of bytes following the header, given by HEADER%(0), plus four bytes in the header.
180 ACTUAL% = 0	Re-initialize the actual number of bytes read in.
190 FLAG% = 1	Because the data is only going to be stored in a file and not seen, no swapping of bytes is necessary.
200 CALL IDENTERB(VNA&, SEG DAT%(2, 0), MAX%, ACTUAL%, FLAG%): GOSUB ERRORTRAP	Read in the data, specifying the beginning array address as two integers (four bytes) before the desired destination of the true data in order to account for the header and therefore maintain data grouping.
210 OPEN "TESTDATA" FOR BINARY AS #1	Open the binary storage file.
220 PUT #1, , HEADER%(0)	Store the number of bytes of the trace data in the storage file.
230 PUT #1, , DAT%(2, 0)	Store the four-byte header in the storage file as two integers.
240 PUT #1, , DAT%(3, 0)	
250 FOR I% = 1 TO HEADER%(0) / 6	
260 PUT #1, , DAT%(1, I%)	Store the trace data in the storage file.
270 PUT #1, , DAT%(2, I%)	
280 PUT #1, , DAT%(3, I%)	
290 NEXT I%	
300 CLOSE #1	Close the storage file.
310 PRINT "CHANGE SETUP AND PRESS <ENTER>."	Display instructions on the computer CRT.
320 DO UNTIL INKEY\$ = CHR\$(13): LOOP	Wait for the operator to change the trace.
330 OPEN "TESTDATA" FOR BINARY AS #1	Open the binary storage file.
340 GET #1, , HEADER%(0)	Read the number of bytes of trace data from the storage file.
350 GET #1, , DAT%(2, 0)	Read the header from the storage file.
360 GET #1, , DAT%(3, 0)	
370 FOR I% = 1 TO (HEADER%(0) / 6)	
380 GET #1, , DAT%(1, I%)	Read the trace data from the storage file.
390 GET #1, , DAT%(2, I%)	
400 GET #1, , DAT%(3, I%)	
410 NEXT I%	
420 CLOSE #1	Close the storage file.
430 A\$ = "SING;": GOSUB IDOUTS	Sweep once to view the current setup's trace on the analyzer and then hold.
440 PRINT "PRESS <ENTER> TO CONTINUE.": DO UNTIL INKEY\$ = CHR\$(13): LOOP	Allow the operator to view the current setup's trace before continuing.
450 A\$ = "INPUDATA;": GOSUB IDOUTS	Prepare the analyzer to read in corrected data.
460 MAX% = HEADER%(0) + 4	The maximum number of bytes to be sent out is the number of bytes following the header, given by HEADER%(0), plus the four bytes in the header.
470 FLAG% = 1	No swapping of bytes is desired.

480 CALL IOOUTPUTB(VNA&, SEG DAT%(2, 0), MAX%, FLAG%): GOSUB ERRORTRAP	Send out the data, specifying the beginning array address as two integers (four bytes) before the address where the true data is stored in order to account for the header.
490 KILL "TESTDATA"	Delete the data file.
500 CALL IOLOCAL(ISC&): GOSUB ERRORTRAP	Return the network analyzer to local mode and perform error trapping.
510 END	End program execution.
520 ERRORTRAP:	Define a routine to trap errors.
530 IF PCIB.ERR <> NOERR THEN ERROR PCIB.BASERR	Perform error trapping.
540 RETURN	Return from the ERRORTRAP routine.
550 IOOUTS:	Define a routine to send a command string from the computer to the analyzer.
560 CALL IOOUTPUTS(VNA&, A\$, LEN(A\$)): GOSUB ERRORTRAP	Send the command string A\$ out to the analyzer and perform error trapping.
570 RETURN	Return from the IOOUTS routine.

### Running the program

1. The computer initiates a transfer using OUTPDATA, reads in the four-byte header as two integers, and terminates the transfer. The second of these integers is the size in bytes of the block of data to follow, and with this, the receiving array is correctly dimensioned.
2. The computer reads in all the trace data requested by OUTPDATA.
3. The computer stores the size of the block of data and the data in the hard disk file TESTDATA. If a hard disk is not available, change the file name on lines 210 and 330 to A:TESTDATA, and make sure that there is a formatted non-write-protected) disk in the A: drive.
4. Change the setup on the analyzer as prompted by the computer by, for example, disconnecting the test device.
5. The computer reads the trace data back in from the storage file, sends the data out to the analyzer, and deletes the storage file.

### Example 3D: Data transfer using markers

The following program illustrates how to transfer data using markers and the command OUTPMARK. In order to read data off a trace using a marker, the marker must first be made active and put at the desired frequency using a command to select a specific stimulus value, like MARK1 133.15MHZ, or a command to do a marker search, like MARK3; SEAMIN. The command OUTPMARK tells the network analyzer to transmit three numbers: marker value one, marker value two, and marker stimulus value. See Table 1 (page 20) to identify the first two marker values according to the current display format. The third marker value, the stimulus value, is either frequency or time, depending on the network analyzer's active domain. These three values can be read in as an array of real numbers using the routine IOENTERA. In this case, there is no header, and MAX% is the maximum number of real numbers to read in (3).

This Example Program is stored on the Example Programs disk as **IPG3D.BAS**.

10	REM \$INCLUDE: 'QBSETUP'	Call the QuickBASIC initialization file QBSETUP.
20	CLS	Clear the computer CRT.
30	ISC& = 7	Assign the interface select code to a variable.
40	VNA& = 716	Assign the analyzer's address to a variable.
50	DISPLAY& = 717	Assign the analyzer's display address to a variable.
60	CALL IOTIMEOUT(ISC&, 10!): GOSUB ERRORTRAP	Define a system time-out of ten seconds and perform error trapping.
70	CALL IOABORT(ISC&): GOSUB ERRORTRAP	Abort any HP-IB transfers and perform error trapping.
80	CALL IOCLEAR(ISC&): GOSUB ERRORTRAP	Clear the analyzer's HP-IB interface and perform error trapping.
90	CALL IOEOI(ISC&, 0): GOSUB ERRORTRAP	Disable the End-Or-Identify mode for transferring data and perform error trapping.
100	DIM VALU!(0 TO 2)	Allocate space to hold data read in from the analyzer.
110	ADDRESS& = VNA&	Initialize the output address to the address of the network analyzer.
120	A\$ = "PRES;": GOSUB IOOUTS	Preset the network analyzer.
130	A\$ = "CHAN1; S21; LOGM;": GOSUB IOOUTS	Make channel 1 the active channel and measure the magnitude of forward transmission parameter S21 in decibels.
140	A\$ = "CENT 134MHz;": GOSUB IOOUTS	Set the center frequency to 134 MHz.
150	A\$ = "SPAN 25MHz;": GOSUB IOOUTS	Set the frequency span to 25 MHz.
160	A\$ = "AUTO;": GOSUB IOOUTS	Autoscale the resulting trace.
170	A\$ = "SING; MARK3; SEAMIN;": GOSUB IOOUTS	Sweep once, hold, and set marker three at the minimum magnitude value of the trace.
180	A\$ = "MARK4; SEAMAX;": GOSUB IOOUTS	Set marker four at the maximum magnitude value of the trace.
190	A\$ = "MARK1 133.15MHz; OUTPMARK;": GOSUB IOOUTS	Set marker one at 133.15 MHz, sweep once, and request marker data from marker one. Since the format is log magnitude, only the first value (the magnitude at the marker in dB) and the third value (the frequency in Hz) read in are significant. → See Table 1.

200 MAX% = 3	Set the maximum number of real numbers to be read in from the analyzer.
210 ACTUAL% = 0	Initialize the actual number of real numbers read in. This variable is given a value by IENTERA.
220 CALL IENTERA(VNA&, SEG VALU!(0), MAX%, ACTUAL%): GOSUB ERRORTRAP	Read in marker data from the analyzer.
230 PRINT " MARKER AT 133.15 MHz:"	
240 PRINT " FROM LOG MAGNITUDE PLOT:"	Display a heading.
250 PRINT TAB(15); VALU!(0); " DB"	Display the magnitude value just read in.
260 GOSUB WAITING	Wait for the user to press any network analyzer key before continuing.
270 A\$ = "PHAS; AUTO;": GOSUB IDOUTS	Display the phase of the active transmission parameter and autoscale the resulting trace.
280 A\$ = "MARK1; OUTPMARK;": GOSUB IDOUTS	Request marker data from marker one. Since the format is phase, only the first value (the phase at the marker in degrees) and the third value (the frequency in Hz) read in are significant. → See Table 1. Note that a single sweep / hold is not necessary here because only format has changed.
290 ACTUAL% = 0	Re-initialize the actual number of real numbers read in.
300 CALL IENTERA(VNA&, SEG VALU!(0), MAX%, ACTUAL%): GOSUB ERRORTRAP	Read in marker data from the analyzer.
310 PRINT " FROM PHASE PLOT:"	Display a heading.
320 PRINT TAB(15); VALU!(0); " DEGREES"	Display the phase value just read in.
330 GOSUB WAITING	Wait for the user to press any network analyzer key before continuing.
340 A\$ = "LINM; AUTO;": GOSUB IDOUTS	Display the linear magnitude of the active transmission parameter and autoscale the resulting trace.
350 A\$ = "MARK1; OUTPMARK;": GOSUB IDOUTS	Request marker data from marker one. Since the format is linear magnitude, only the first value (the linear magnitude) and the third value (the frequency in Hz) read in are significant. → See Table 1.
360 ACTUAL% = 0	Re-initialize the actual number of real numbers read in.
370 CALL IENTERA(VNA&, SEG VALU!(0), MAX%, ACTUAL%): GOSUB ERRORTRAP	Read in marker data from the analyzer.
380 PRINT " FROM LINEAR MAGNITUDE PLOT:"	Display a heading.
390 PRINT TAB(15); VALU!(0); " UNITS"	Display the magnitude value just read in.
400 GOSUB WAITING	Wait for the user to press any network analyzer key before continuing.

410 A\$ = "SMIC; AUTO; SMIMRX;": GOSUB IOOOTS	Display the Smith chart of the active transmission parameter and autoscale the trace. Set the marker data to be given in the form $R + jX$ .
420 A\$ = "MARK1; OUTPMARK;": GOSUB IOOOTS	Request marker data from marker one. In this configuration, the first value (real in ohms), the second value (imaginary in ohms), and the third value (the frequency in Hz) read in are significant. → See Table 1.
430 ACTUAL% = 0	Re-initialize the actual number of real numbers read in.
440 CALL IOENTERA(VNA&, SEG VALU!(0), MAX%, ACTUAL%): GOSUB ERRORTRAP	Read in marker data from the analyzer.
450 PRINT " FROM SMITH CHART:"	Display a heading.
460 PRINT TAB(15); VALU!(0); " + j "; VALU!(1); " OHMS"	Display the normalized impedance values just read in.
470 GOSUB WAITING	Wait for the user to press any network analyzer key before continuing.
480 A\$ = "POLA; AUTO; POLMRI;": GOSUB IOOOTS	Display the active transmission parameter in polar form and autoscale the trace. Set the marker data to be in the form real/imaginary.
490 A\$ = "MARK1; OUTPMARK;": GOSUB IOOOTS	Request marker data from marker one. In this configuration, the first value (real), the second value (imaginary), and the third value (the frequency in Hz) read in are significant. → See Table 1.
500 ACTUAL% = 0	Re-initialize the actual number of real numbers read in.
510 CALL IOENTERA(VNA&, SEG VALU!(0), MAX%, ACTUAL%): GOSUB ERRORTRAP	Read in marker data from the analyzer.
520 PRINT " FROM POLAR PLOT:"	Display a heading.
530 PRINT TAB(15); VALU!(0); " + j "; VALU!(1); " UNITS"	Display the values just read in.
540 CALL IOLOCAL(ISC&): GOSUB ERRORTRAP	Return the network analyzer to local mode and perform error trapping.
550 END	Perform error trapping.
560 ERRORTRAP:	Define a routine to trap errors.
570 IF PCIB.ERR <> NOERR THEN ERROR PCIB.BASERR	Perform error trapping.
580 RETURN	Return from the ERRORTRAP routine.
590 IOOOTS:	Define a routine to send a command string from the computer to the analyzer.
600 CALL IOOUTPUTS(ADDRESS&, A\$, LEN(A\$)): GOSUB ERRORTRAP	Send the command string A\$ out to the analyzer and perform error trapping.
610 RETURN	Return from the IOOOTS routine.
620 WAITING:	Define a routine to display a prompt on the network analyzer's display and wait for the user to press any key before continuing.
630 ADDRESS& = DISPLAY&	Reset the output address to the network analyzer's display.



640 A\$ = "PU; PA 390,3600; PD; LBPRESS ANY KEY TO CONTINUE" + CHR\$(3): GOSUB IOOOTS	Write a prompt on the network analyzer's display.
650 ADDRESS& = VNA&	Return the output address to the network analyzer.
660 A\$ = "CLES; ESE64;": GOSUB IOOOTS	Set up the status reporting system so that bit 6, User Request, of the Event Status Register is summarized by bit 5 of the Status Byte, allowing a key press to be detected by a serial poll.
670 A\$ = "ESR?;": GOSUB IOOOTS	Request the Event Status Register value from the analyzer.
680 CALL IOENTER(VNA&, ESTAT!): GOSUB ERRORTRAP	Receive the Event Status Register value from the analyzer, thereby clearing the latched User Request bit so that old key presses will not trigger a measurement.
690 STAT% = 0	Initialize STAT% for entry into the DO UNTIL loop.
700 DO UNTIL ((STAT% MOD 64) > 31)	Wait for a key press to be indicated by the setting of bit 5 in the status byte. MOD 64 removes the effect of all higher value bits (bit 6 is equivalent to 64 in decimal), and > 31 ensures that bit 5, which is equivalent to 32 in decimal, is set.
710 CALL IOSPOLL(VNA&, STAT%): GOSUB ERRORTRAP	Read in the status byte as an integer.
720 LOOP	
730 ADDRESS& = DISPLAY&	Reset the output address to the network analyzer's display.
740 A\$ = "PG;": GOSUB IOOOTS	Clear old user graphics from the network analyzer's display.
750 ADDRESS& = VNA&	Return the output address to the network analyzer.
760 RETURN	Return from the WAITING routine.

### Running the program

1. The computer sets up a trace on the analyzer and puts markers at the maximum and minimum log magnitudes of the trace as well as at a specific frequency.
2. The computer reads in the data from marker one read out by OUTPMARK. Press any key on the analyzer front panel to continue the program, go on to a new display format, and read in its data from marker one. Note that only the identity of the first two marker data values varies with the current display format and marker mode; the command to read out the marker data, OUTPMARK and the number of values to be read (3) is always the same.